

Condition Assessment and Rehabilitation Plan Hangar One

for NASA Headquarters and
Ames Research Center, California

Volume 1
Condition Assessment



Hangar One – Ames Research Center, Moffett Field, CA

1.0 Executive Summary – Condition Assessment and Rehabilitation Plan

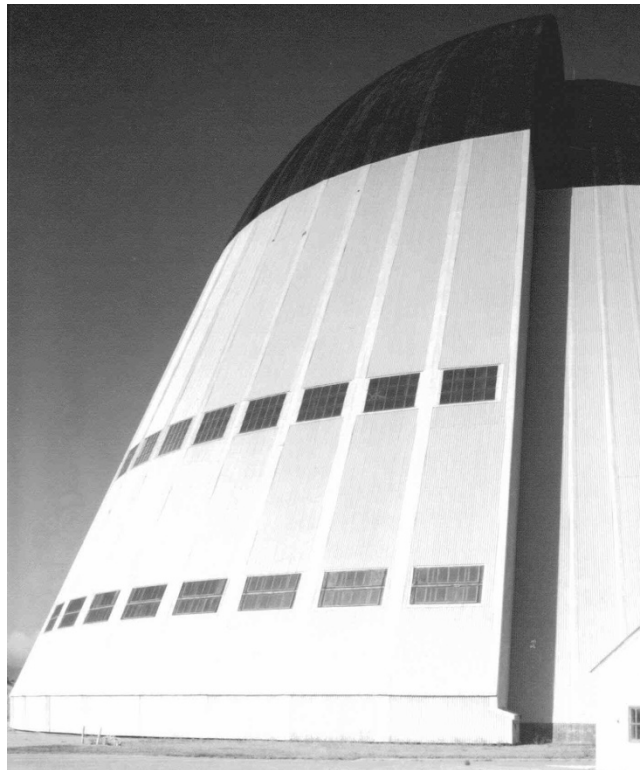

This Condition Assessment and Rehabilitation Plan provides analysis of the existing conditions and various options for the re-skinning and re-use of Hangar One, Ames Research Center, Moffett Field, CA. Hangar One is a historic structure undergoing removal of contaminated materials, primarily leaving a steel structure. Hangar One is a major contributing component within the Shenandoah Plaza National Historic District. The district was listed on the National Register of Historic Properties in 1994 and the hangar was also recognized as a California historic civil engineering landmark in 1977 and a Naval historic Site in 1966.

The current siding removal project is being performed by and in coordination with the U.S. Navy, which had former stewardship of the hangar. A Condition Assessment and Rehabilitation plan is required to evaluate the condition of the facility and to enable potential re-use alternatives, identify requirements and potential costs.

The Condition Assessment utilizes and references many of the previous reports, studies and photographs completed and/or compiled to date by NASA. Much of this information is provided within the body of this assessment, included as an Appendix or listed in the Bibliography.

CH2M Hill conducted a two-day, on-site observation of the facility and ongoing Navy removal action on July 25th and 26th, 2011. CH2M Hill was also on-site on August 16, 2011 to observe the preparation and application of special coatings to the hangar steel superstructure that is part of the ongoing removal action to protect the exposed hangar structural elements.

Summary of Existing Conditions

All siding, man doors, roof, and windows are being removed. Attempts at salvaging corrugated windows were unsuccessful. The steel framing that remains is being covered in a special coating to provide a protective barrier over remaining hazardous materials. This coating also provides protection from the weather for up to twelve years, according to specified warranties.

Structurally, the building is located in a seismic zone. A geotechnical analysis was done as part of this study to provide structural engineering parameters for design analysis. This analysis determined that the site contains liquefiable soils. To complete an analysis of the structural frame of the building in accordance with current codes, the soils were assumed to be strengthened and cost associated with strengthening are

included in this report. The structural analysis determined that, while there are deficiencies within the structural frame, there are no immediate structural urgencies requiring repair. Members which need reinforcing have been identified. Additional analysis may also be performed which could reduce the soil mitigation required and reduce the number of members needing reinforcement, but that additional level of analysis was not part of this study. That level of analysis could be done as a Value Engineering alternative as part of the future design-build contract

Summary of Rehabilitation Plan

The Rehabilitation Plan discusses structural improvements, material replacement alternatives, and specialized construction issues. Materials analyzed are rated using a system for alternatives developed by preservation architects and their understanding of the relevant historic requirements. These material alternatives are the recommendations of the CH2M HILL team, and have not been presented to or formally reviewed by either the state or federal preservation entities that have oversight responsibilities for the Shenandoah Plaza National Historic District.

This report includes Options A through F, which are summarized as follows:

Option A – Basic Re-Skinning, Maintain Existing Hangar Use: Option A includes all requirements to re-use the building as a hangar. Under this scheme, the hangar would receive new concealed fastener siding, both corrugated and flat panel windows, and metal deck roofing matching as close as possible to the appearance of the original historic design. Option A also includes basic utility infrastructure for lighting and toilet rooms. This option does not include structural upgrades for the hangar.

Option B – Re-Skinning with Upgrades (Geotechnical, Structural and Slab) and Re-Use as a Hangar to meet California Historical Building Code: In addition to all improvements identified in Option A, Option B includes soil strengthening and structural improvements to meet California Historical Building code and Executive Order 12941.

Option C – Re-Skinning with Upgrades (Geotechnical, Structural and Slab) and Re-Use as a Hangar to meet California Historical Building Code with Historic Consideration: Structural improvements identified in Option B are not considered to negatively impact the historic look and feel of the building.

Option D – Adaptive Re-Use, Re-Skinning with Upgrades and Re-Use as a Higher Occupancy Level (Assembly, or Mixed Use): Under Option D, occupancy of the building will be increased to assume potential alternatives for Assembly and Mixed Use occupancies. In addition to improvements identified in Option B, larger infrastructure for increased facility services and Life Safety requirements in compliance with the 2010 California Building Code would be included due to the change in occupancy.

Option E1 – Layaway Plan after Re-Skinning: Includes estimated costs for annual, cyclical maintenance for the re-skinned hangar.

Option E2 – Layaway Plan without Re-Skinning: Includes estimated costs for annual, cyclical maintenance for the un-skinned hangar.

Option F – Building Demolition: Includes estimated costs associated with demolition of the remaining structure, concrete foundations and concrete hangar floor slab.

Table of Contents

1.0 Conditional Assessment Executive Summary

Volume I – Conditional Assessment

Introduction – Conditional Assessment

2.0 Architectural Conditional Assessment	1
2.A General Architectural System Description – Building Envelope	1
2.B General Architectural System Description – Building Interior.....	6
2.C General Code Related Issues – Code Analysis	8
2.D General Historic Preservation Issues – Architectural.....	8
2.E Current Work	10
3.0 Structural Condition Assessment.....	12
3.A General Structural System Description.....	12
3.B Foundation System	17
3.C Connections	18
3.D Wood Members in the Structure	18
3.E Catwalks and Stairs	19
3.F Condition of Existing Members	19
3.G Significant Repairs to Date.....	20
3.H Miscellaneous Items.....	20
4.0 Structural Analysis	23
4.A Summary	23

4.B Introduction.....	23
4.C Structural System Description	24
4.D Geotechnical Investigation	24
4.E Evaluation and Analysis.....	24
4.F Analysis of Results	26
4.G Conclusion	26
4.H RISA 3-D Graphic Models	28
5.0 Geotechnical Report	34
5.A Introduction.....	34
5.B Subsurface Conditions	36
5.C Seismic Ground Motions	37
5.D Engineering Analysis	40
5.E Design Soil Engineering Parameters	41
5.F Pile Foundation	42
5.G References	45

Volume II – Rehabilitation Plan

Introduction – Rehabilitation Plan

6.0 Introduction – Rehabilitation Plan and Options Analysis	1
6.A Rehabilitation and Re-Use Options.....	1
6.B Material Replacement and General Discussion of Material Alternatives....	6
6.C Impacts to the Historic Resource.....	12
6.D Steel Coatings.....	19
7.0 Structural	20

7.A Impacts to the Historic Resource.....	20
7.B Structural Analysis and Retrofit Requirements.....	21
7.C Miscellaneous Structural Rehabilitation Requirements	27
7.D Geotechnical Remediation.....	27
8.0 Mechanical and Plumbing Systems	27
8.A General Mechanical and Plumbing Discussion, Options Analysis	27
8.B Moisture and Interior Climate Issues (Options A through D).....	28
9.0 Fire Protection.....	29
9.A Fire Protection, Options Analysis.....	29
9.B Fire Alarm and Mass Notification Systems.....	29
10.0 Electrical, Public Address and Communication Systems.....	30
10.A Power Systems	30
10.B Communication Systems.....	30
10.C Options Analysis	31
10.D Analysis of Solar Photovoltaic Systems.....	31
11.0 Specialized Construction Issues – Means/Methods Discussion.....	31
11.A Site Access and Conditions – Post-Removal Action	31
11.B Metal Siding and Window Installation Issues	32
11.C Health and Safety Discussion	32
11.D Phasing and Sequencing.....	32
11.E Site Utility Access, Conditions and Locations	32
12.0 Support Drawings	34
12.A Plans	34
12.B Installation Details, Existing Condition	40

12.C Installation Diagrams & Conceptual Details	43
-------------------------------------------------------	----

Volume III – Appendices

A Bibliography
B Current Condition Survey
C Page Turnbull Code Issues Matrix
D Utility Condition Drawings
E Hangar One Historic Items Release and Transfer Form
F Hangar One Prelim Fire Risk Assessment.pdf
G Structural Retrofit Requirements
H Structural Calculations (Electronic Only)
I Hangar One Architectural Façade Study (Electronic Only)
J NASA Soil Contamination Boring Result Maps
K As-Built Drawings (Electronic Only)
L AECOM As-Built Drawings (Electronic Only)
M Re-Use Guidelines, Page & Turnbull, Inc. (Electronic Only)
N Potential Materials and Providers

Volume IV – Cost Estimate

Condition Assessment – Hangar One, Ames Research Center, Moffett Field CA

Introduction – Condition Assessment



This Condition Assessment is prepared by CH2M HILL for the NASA Headquarters and Ames Research Center and serves to document the existing conditions, historic significance and discusses the ongoing removal action being carried out by the Navy for Hangar One, Ames Research Center, Moffett Field, CA. This Condition Assessment is intended to provide NASA with a clear understanding of the associated issues of repairing and re-skinning the hangar structure to meet historic requirements and to set the stage for potential future re-use of the hangar structure that will be discussed more fully in the Rehabilitation Plan. The Rehabilitation Plan will include more detailed analysis of a potential layaway plan for the structure, re-skinning requirements and re-use options, including detailed cost estimates for each.

This Condition Assessment utilizes and references many of the previous reports, studies and photographs completed and/or compiled to date by NASA. Much of this information is provided within the body of this assessment, included as an Appendix or listed in the Bibliography.

CH2M HILL conducted a two-day, on-site observation of the facility and ongoing Navy removal action on July 25 and 26, 2011. CH2M HILL was also on-site August 16, 2011 to observe the preparation and application of special coatings to the hangar steel superstructure that is part of the ongoing removal action to protect the exposed hangar structural elements.

Background Information – Hangar One

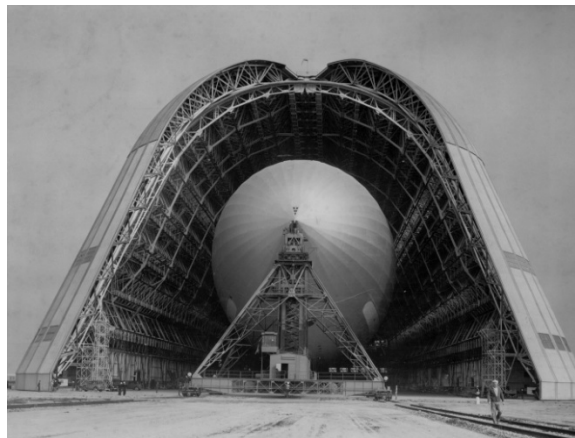

Hangar One was constructed in 1932 to house the USS Macon, a lighter than air ship, that supported U.S. Naval Operations on the west coast. The USS Macon crashed in 1935. This event set Hangar One on a course of multiple occupants and uses of its life with construction of free standing interior structures on the hangar interior as well as addition and reconfiguration of original interior spaces that served as hangar support, classrooms and offices.

In 1997, as a result of routine testing NASA Ames detected toxins within the Center's storm drain system. Through analysis these toxins were determined to be Aroclor 1268, a form of polychlorinated biphenyl (PCB). Through additional research and analysis this toxin was traced in 2002 back to the original metal panel siding on the exterior of Hangar One. The U.S. Navy is currently in the process of removal action to remove contaminated materials from the structure. As part of this removal

action, the entire exterior skin, as well as additional accessories and components (discussed in more detail within the body of this Condition Assessment) are being removed. The existing steel structure will be left in place with a special coating applied to provide a protective coating over the lead primer and PCB's, as well as provide anti-corrosion properties.

Hangar One is a major contributing component within the Shenandoah Plaza National Historic District. The district was listed on the National Register of Historic Properties in 1994 and the hangar was also recognized as a California historic civil engineering landmark in 1977 and a Naval historic site in 1966.

2.0 Architectural Condition Assessment

2.A General Architectural System Description – Building Envelope

Hangar One was designed and built in the early 1930s to originally house and service the USS Macon which was based at Moffett Field, California. The architectural design and exterior aesthetic of the hangar is described as Streamline Moderne style. Key attributes of the Streamline Moderne style that are evident in the design of Hangar One are horizontal orientation, rounded edges and smooth exterior surfaces. The teardrop shape and horizontal window banding of Hangar One along with the Streamline Moderne characteristics work harmoniously to give the illusion of speed and mimic the shape of the dirigible that it once contained.

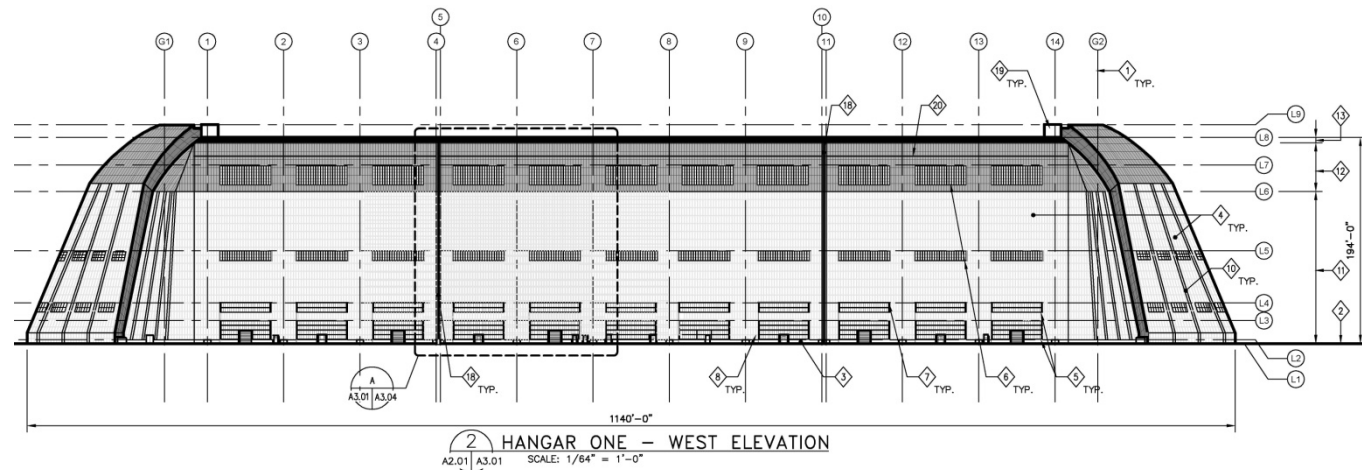

Figure 2.1

The hangar was originally skinned with metal panels in two distinct profiles. These metal panels are considered to be part of the character defining historic characteristics of the hangar and are identified in this report as Metal Wall Panel – Profile One (V-Beam Siding) and Metal Wall Panel – Profile Two (Mansard Siding). The majority of the exterior skin, including the clam shell hangar doors are covered with Metal Wall Panel – Profile One from the ground level to a transition point located 132 feet 6 inches above the hangar floor. At this transition point the wall panel profile changes to Metal Wall Panel – Profile Two while also changing from a flat wall surface to a curved wall surface. There is a small section of built-up roofing (BUR) that is located at the crown of the teardrop shape. There is a sloped concrete foundation, approximately 4 feet tall at the base of the exterior walls that the metal wall panels sit upon.

There is approximately 650,000 square feet of outer surface area of the hangar structure consisting of metal panels and built-up roofing materials. Although later modifications to the hangar provided a black coating above the metal panel transition point, the original hangar appearance was a monochromatic aluminum color.

2.A.1 Metal Wall Panels – Profile One (V-Beam Siding)

The largest area of metal siding on Hangar One is Profile One (the current area painted silver) with an approximately 2 inch deep trapezoidal, V-Beam shape. The existing metal panels are approximately 30 inches wide by 9 feet long with exposed fasteners located at approximately 7 feet 6 inches spacing horizontally. The heads of the exposed fasteners have been covered by application of multiple coatings applied to the metal panels.

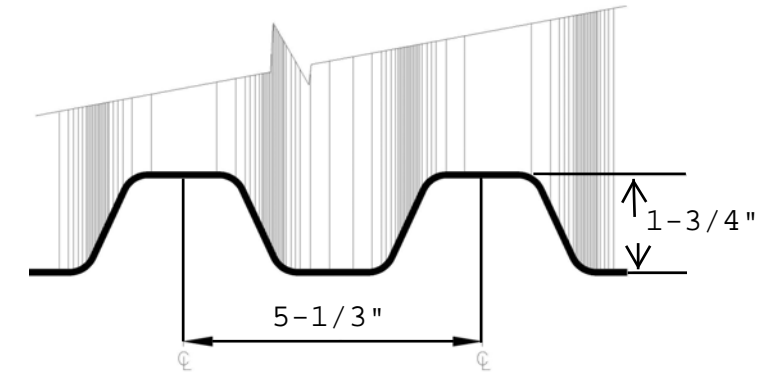

Figure 2.2

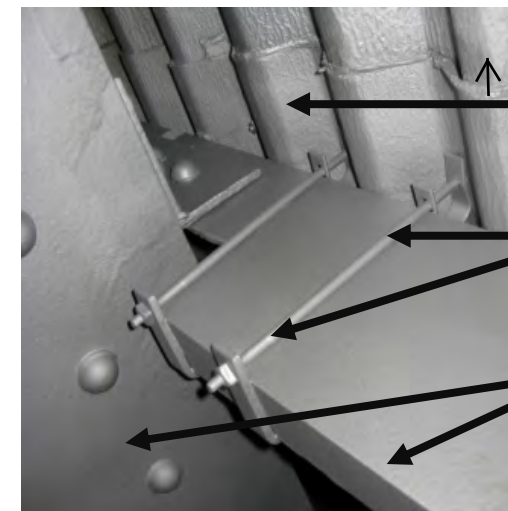

Figure 2.3

The panel profile dimensions shown in Figure 2.2 have been confirmed in the field by removing the multiple layers of coatings and field measuring the panels.

The steel superstructure of the hangar has been provided with a steel channel panel support framework with vertical and horizontal girts for attachment of these metal wall panels. The metal wall panels are attached to the horizontal girts with metal retention clips that consist of threaded rods, j-clips and nuts that are spaced at approximately 11 inches on center (see figure 2.3). These retention clips and bolts will be removed as part of the ongoing Navy removal action.

2.A.2 Metal Wall Panels – Profile Two (Mansard Siding)

The upper portion of metal wall panel (or the area historically referred to as the Mansard Siding) has a different profile than the V-Beam shape with convex ribs. These Mansard Siding panels are currently covered with a black, fluid-applied bituminous coating but were originally a silver colored panel to match the V-Beam panels below. The black coating was added to help create a higher surface temperature which in

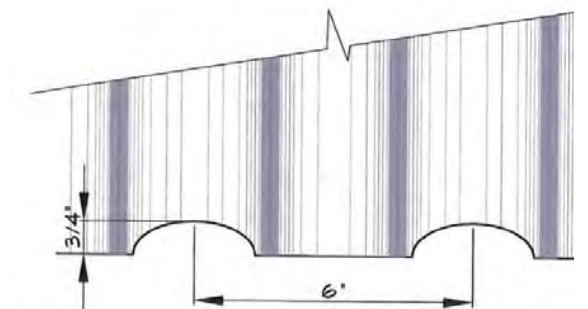

Figure 2.4

turn works to reduce the potential for condensation to develop on the interior of the hangar roof surfaces.



Figure 2. 5

Figure 2. 6

The Mansard Siding Panels are attached to the structure of the building with exposed fasteners through redwood decking (see figure 2.5 and 2.6). The redwood decking occurs above the metal wall panel transition point and is the backing material for both the Mansard Siding and the built-up roofing system at the crown of the structure. The redwood decking members are attached to wood runners that connect to the steel superstructure with steel angles.

2.A.3 Metal Panel Finishes

The original metal panel system materials were considered innovative for the time period of design and construction. The metal panels are galbestos panels which are composed of profiled steel panels with asbestos felt and bitumen coatings on each side. This composition provided fire-resistant materials for the hangar structure. In 2003 it was discovered that the coatings on the metal panels were leaking toxic chemicals into NASA's storm water settling basin and retention ponds. The chemicals found from the coatings are lead and asbestos but also include polychlorinated biphenyls (PCBs). As of April 2011 the Navy is in the process of removing the contaminated metal panels as part of an ongoing removal action. The existing redwood decking located behind the Mansard Siding and Built-Up Roofing also contains these toxic chemicals and is being removed as part of the current removal action.

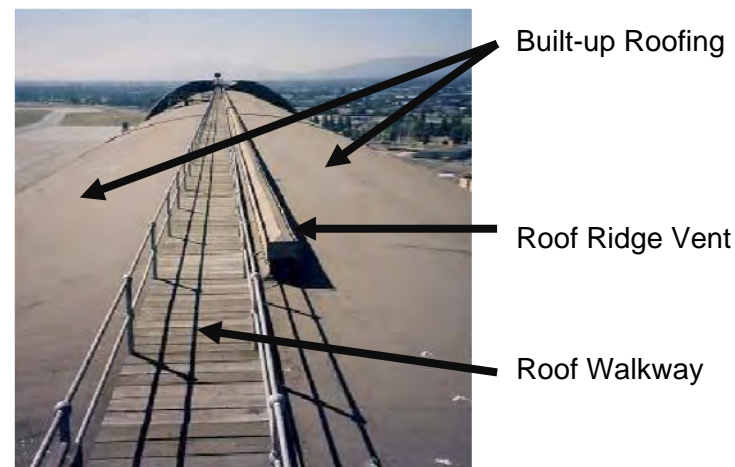

Figure 2. 7

2.A.4 Built-Up Roofing System

The extreme upper portion (the crown) of the hangar structure is covered with a built-up roofing system. This system is currently black in color and consists of the roofing system on top of redwood decking (noted as sheathing in the original documents). This area of built-up roofing is approximately 40 feet wide and runs the length of the hangar structure at the crown. At the peak of the hyperbolic curve

of the hangar structure is a roof ridge vent and a walkway (see figure 2.7) with railings that run the length of the hangar. The walkway is supported by a steel structural frame that is raised above the built-up roof, which passes beneath the walkway. The walkway facilitates access of the hangar roof and also provides access to the roof mounted beacons and obstruction lights. Access to these features shall be maintained at all times for maintenance purposes prior to, during and following the ongoing Navy removal action and will need to be maintained during future rehabilitation efforts. There is also a large holiday star located on top of the hangar that automatically illuminates nightly at certain times of the year.

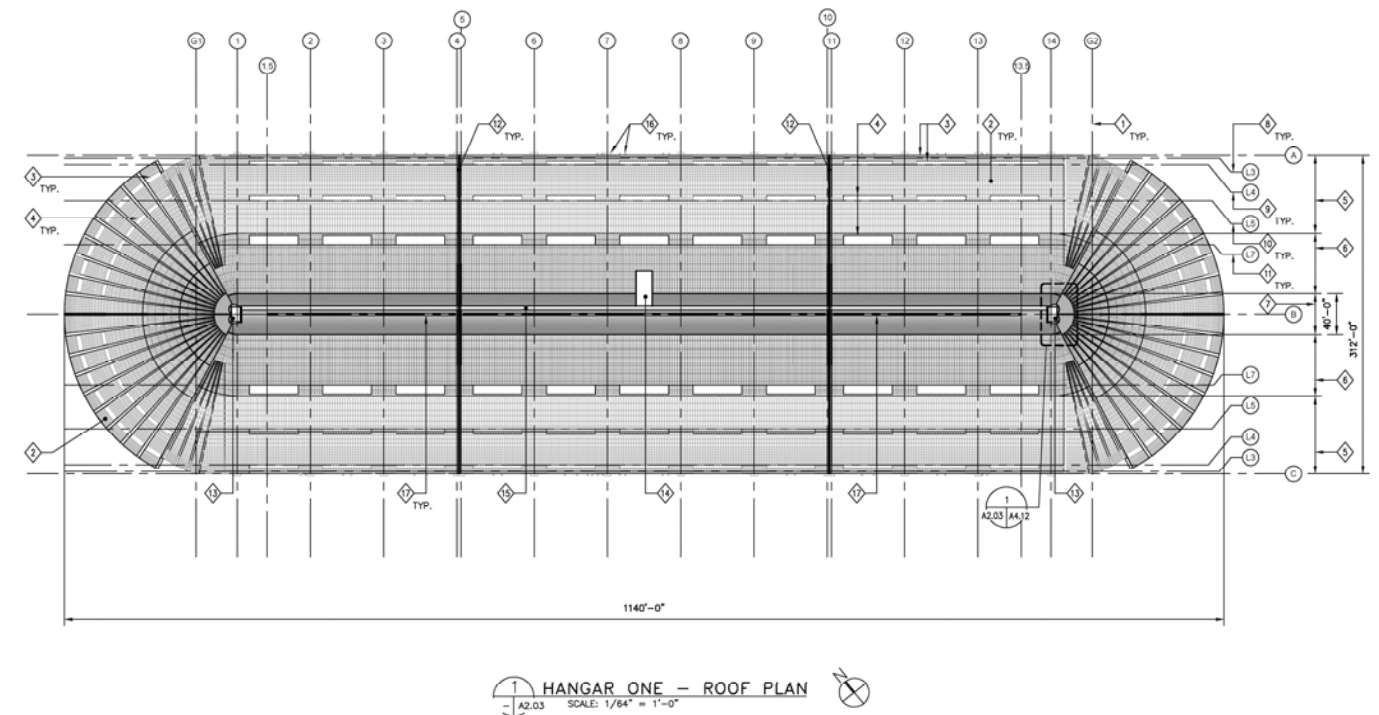

Figure 2. 8

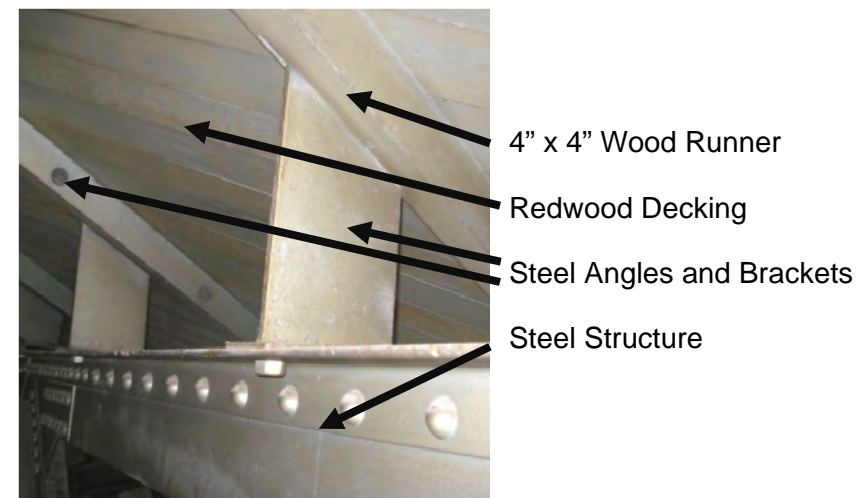

Figure 2. 9

Copper flashings are provided at the transition between the built-up roofing and the Mansard Siding below. This copper flashing matches the profile of the Mansard Siding. There is a steel bracket and steel pipe rail system that projects beyond the face of the Mansard Siding approximately one foot that is located on the east and west facades of the building directly above the upper horizontal set of windows. It is believed that these railings are provided as a safety measure in case of a fall from the upper portion of the hangar roof.



Figure 2.10

There are also two dog houses located at the north and south ends of the roof for access to the hangar door pivots and a central access platform where access to the walkway is provided. The current railing configuration on the walkway does not meet OSHA requirements for guardrail height. The existing wood decking of the exterior roof walkway and contaminated wood on the internal catwalks will be removed with the ongoing Navy removal action. The railings and steel structure will remain.

Similar to the redwood decking attachment noted earlier in this assessment for the Mansard Siding, the redwood decking at the built-up roofing system attaches to the steel superstructure with wood runners, approximately 4 inch by 4 inch, attached to steel angles that reach back to the hangar trusses with additional angles and brackets (see figures

2.9 and 2.10). As part of the removal action currently in progress at the hangar these redwood planks and the wood runners are being removed.

A black fluid-applied bitumen coating was added to the Mansard Siding visually giving the hangar a larger “roof” area. This is the black portion on the existing hangar exterior. This is not the original design intent of the building and is not intended to be replaced as part of the Rehabilitation Plan. The black coating was added after the original construction of the hangar in the 1950s in an effort to address some of the environmental and moisture problems that were being encountered in the hangar. By providing this black coating on the roof of the building the upper portion carries a higher surface temperature which in turn reduces the potential for moisture to develop on the inside of the hangar. When the hangar is re-sided with a non-black portion of roof at the Mansard Siding, care must be taken to alleviate this same potential problem but with a solution that maintains the original appearance of the metallic, aluminum-colored siding.

2.A.5 Hangar Doors

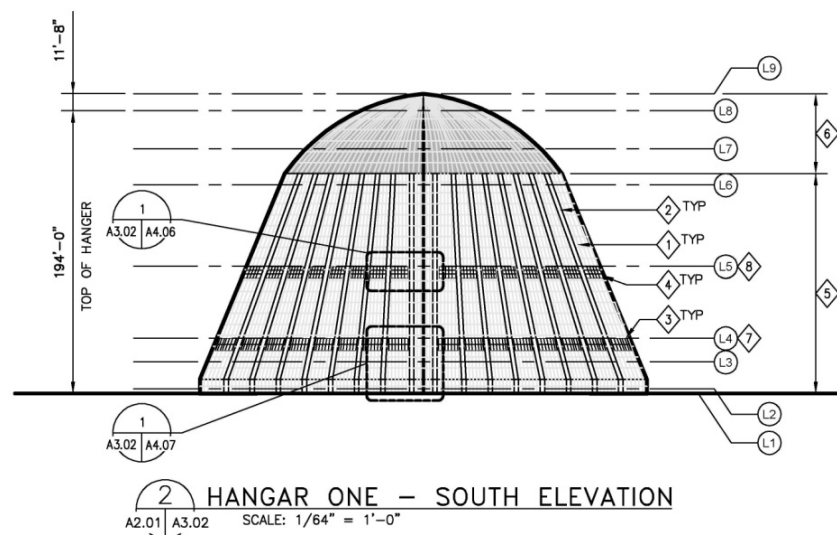

Figure 2.11

Large “clam shell” or “orange peel” hangar doors are located at both the north and south ends of the hangar structure. Each half-dome shaped hangar door has two independent leaves and operate by running on steel-wheeled travelers that are set on tracks. 150 horsepower, electric motors operate the travelers to retract the hangar door panels to their open position. As designed each leaf of the hangar doors traveled approximately 12 feet per minute and took approximately 12 minutes to fully open or close.

Unlike the east and west sides of the

hangars that have four sets of horizontal windows, the hangar doors have two sets of horizontal windows. The lower band of hangar door windows is a flat glass profile. The upper band of hangar door windows is a corrugated glass profile.

2.A.6 Hangar Door Motors



Figure 2.12

There are four individual motors that operate the hangar doors – one motor for each door leaf. The south hangar doors were last known to be operational in 2001 according to the Page & Turnbull Condition Matrix (see Appendix B) but have not been operated since. Additionally, at this time only three of the four motors are known to be operational. The non-working motor is located on the north hangar door. The last known operational date for the north hangar doors is not known. Each motor is located on top of a concrete curb, inside the hangar. They are located on either side of the hangar door openings. Of the three remaining operational hangar door motors it is expected that each will require maintenance and cleaning in order to become fully functional in the future. The missing motor will need to be replaced, or located, refurbished, and re-installed.

There are two dog houses at the top of the hangar that contain mechanisms for the hangar doors. These mechanisms have leaked oil over time. As part of the Navy removal action the oil has been drained and the dog houses cleaned. Some items may not be able to be thoroughly cleaned due to inability to completely disassemble some pieces or difficult locations of equipment.

2.A.7 Hangar Door Trucks and Rails



Figure 2.13

Each hangar door leaf sits on nine trucks (see figure 2.13) that consist of support for the door leaf and a series of wheels that roll on tracks that are mounted within the concrete hangar floor slab. These tracks extend beyond the building enclosure and allow the hangar door leaves to roll into their fully open position. At the end of each set of tracks is a door stop that would protect the hangar from the doors opening too far. The wheel and trucks appear to be in relatively decent shape based on visual inspection but because they have not been operational for many years they would require maintenance and cleaning in order to bring them to a fully functional state of operations. These motors may need electrical components replaced as well in order to meet current regulations.

As part of the Navy’s removal action they will be draining oil from the trucks and providing overall thorough cleaning of all mechanisms. Some items may not be able to be thoroughly cleaned due to inability to completely disassemble some pieces or difficult locations of equipment. A site

visit was scheduled for November 2, 2011 between NASA and the Navy to review the conditions of these items.



Figure 2. 14



Figure 2. 15

The hangar door tracks consist of standard gauge railroad tracks that are attached directly to the concrete below with steel brackets. Composite material filler members have been installed around the tracks (see figures 2.14 and 2.15) as a safety precaution to fill the leftover large gaps and to allow for carts or other objects to be rolled over the tracks. It has recently been identified that these composite

filler members contain asbestos and will be removed as part of the ongoing Navy removal action. The steel rails will be left in place. Although not considered historic these filler members may need to be replaced for future use as a safety precaution.

2.A.8 Miscellaneous Hangar Door Details



Figure 2. 16



Figure 2. 17

The hangar door exterior is covered with the same distribution of metal wall panels as the main hangar body. In order to give the visual look of the curved “clam shell” or “orange peel” the hangar doors are built in smaller segments (see figure 2.16). The smaller vertical portion of the hangar door base covers the height of the trucks used in the operation of the doors. The interior of the

hangar door is exposed steel structure and framing similar to the rest of the hangar interior. The window banding extends around the width of these clamshell doors.

At the center of each hangar door where the two door leafs come together there are a pair of rubber seals that are covered on the exterior with a set of flat steel cover plates and on the interior with a half-round copper/steel backing plate (see figure 2.17).

At the ends of the hangar doors where they meet with the hangar, the doors overlap the building in order to keep rain and weather out of the building interior when the hangar doors are in their closed position. At the

tops of the hangar doors there are large pivot components within the door enclosure that can be accessed by the previously mentioned north and south roof dog houses. Both of these pins, or pivot points, is leaking oil and will require repairs to make them operational. As part of the Navy’s action removal these mechanisms will be drained and thoroughly cleaned.

2.A.9 General Architectural Description - Windows

The hangar is provided with four horizontally oriented sets of windows along the east and west facades and two sets of horizontally oriented windows on the north and south facades, which are located in the “clam shell” hangar doors. The windows occur in two distinct profiles. These profiles are identified in this report as Window Profile One – Flat Wired Glass and Window Profile Two – Corrugated Wired Glass.

Along the east and west facades, the bottom two horizontal bands of windows are Window Profile One – Flat Wired Glass and the upper two horizontal bands are Window Profile Two – Corrugated Wire Glass. Each horizontal band is comprised of uniformly sized, smaller window panels approximately 2 feet wide by 3 feet 8 inches tall varying in quantity based on their location.

Window Profile One – Flat Wired Glass, lower band This is the lowest set of windows on the building exterior and begins at the top of the four foot tall, sloped concrete foundation wall. There are four horizontal bands of smaller window panels in this configuration. Of the four smaller horizontal bands the first and third bands have hinges at the tops of the panels allowing for operational windows. The lowest horizontal band also contains periodic panels of louvered glass.

Window Profile One – Flat Wired Glass, upper band There are two horizontal bands of smaller window panels in this configuration.

Window Profile Two – Corrugated Wired Glass, lower band There are three horizontal bands of smaller corrugated window panels in this configuration.

Window Profile Two – Corrugated Wired Glass, upper band This is the upper most set of windows on the building. There are six horizontal bands of smaller window corrugated window panels in this configuration.

The existing windows are mostly intact but are in fairly poor condition. Many of the lowest sets of windows are damaged and have been broken over time. The corrugated glass is also cracked and broken in many places. It was the original intent to salvage and re-install the windows as part of the rehabilitation of the hangar. However, the full extent of window damage is too great to support salvage and repair of the existing window systems (frames and glazing). Therefore, the Rehabilitation Plan calls for all windows and frames to be replaced as part of the rehabilitation process.

2.A.10 Window Profile One – Flat Wired Glass

The flat glass profile occurs at the lower two sets of horizontally oriented windows on the east and west facades of the hangar and on the lower set of windows at the hangar doors. Some of the windows in the lowest set on the east and west facades are louvered and or hinged for operability (see figures 2.18 and 2.19).



Figure 2.18



Figure 2.19

The frames of the windows consist of an industrial window framing system that is built-up steel angles and small steel members that make up the smaller panel frames. The steel window frames and mullions are non-thermally broken frames while the glazing is single-pane, non-insulated glass. These are interconnected to each other with simple bolted connections and additional steel framing that is attached to the

building steel superstructure with channel girts that connect directly to the hangar trusses with a series of brackets, angles and bolted connections.

The steel window frames are painted to match the adjacent exterior finishes (white at the lower set of windows to match the sloped concrete foundation base and metallic color at the upper sets to match the metal panel finishes). At the interior, the framing is all painted to match the metallic color of the steel trusses and superstructure framing.

2.A.11 Window Profile Two – Corrugated Wired Glass

The corrugated windows represent one of the important features contributing to the historic value of the exterior of the hangar. Chicken wire panels with wooden frames have been installed at the interior of the windows (see figure 2.21) in isolated locations in order to minimize the potential for broken pieces of the glass to fall to the hangar floor below.

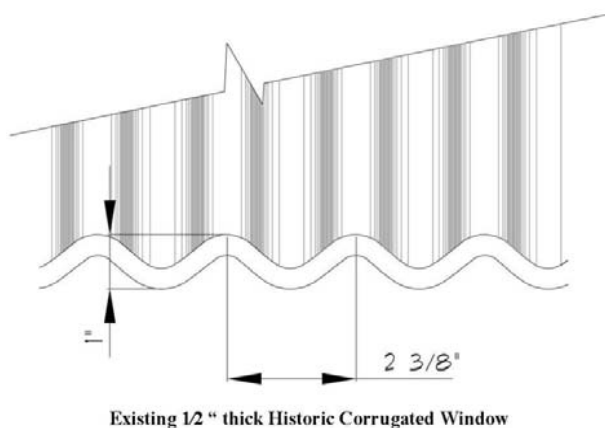

Figure 2.20

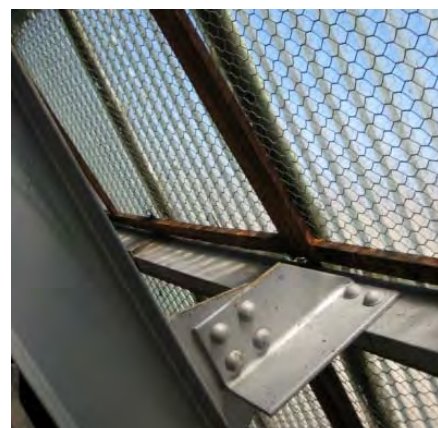

Figure 2.21

Unlike the flat glass window sets there are not any hinged or louvered glass panels within the areas of corrugated windows. Similar to the flat glass windows panels the corrugated window panels are held in place with steel frames that are composed of mullions

built-up with steel angles and small steel members that are connected to the steel hangar trusses with bolted connections to steel channel girts (see figure 2.21).

2.A.12 Miscellaneous Components and Details – Man Doors

The building exterior is serviced by numerous man doors, many that are of the original design and construction and many that have been added since original construction for the various occupants and uses of the hangar. In reviewing historic documents the original hangar was provided with six man doors each on the east and west façade. The current configuration has twelve man doors on the east side and eleven man doors on the west side. Figures 2.22, 2.23 and 2.24 show different man door conditions. Some include canopy covers. All man doors pass through the sloped concrete foundation wall and are provided with gutters and downspouts to address water and moisture draining from the metal wall panels above. All doors, frames, hardware, canopies, gutters, downspouts and other miscellaneous components are being removed as part of the Navy's removal action.



Figure 2.22



Figure 2.23



Figure 2.24

2.A.13 Miscellaneous Components and Details – Overhead and Sectional Doors

In addition to housing the USS Macon, Hangar One also provided facilities to house and maintain Sparrowhawks, small fighter airplanes used for scouting and defense of the dirigible. On the eastern side of the hangar there is a large door opening that facilitated the entry of these airplanes (see figure 2.25). This door opening was a sectional door that was an addition to the hangar after original construction.

Overhead doors for truck access and miscellaneous access into the hangar were originally provided at every other structural grid bay from the man doors indicated above. Similar to the man doors all overhead access and sectional doors are provided with a gutter and downspouts to address water and moisture draining from the metal wall panels (see figure 2.26). All doors, frames, hardware, canopies, gutters, downspouts and other miscellaneous components are being removed as part of the Navy's removal action.



Figure 2.25

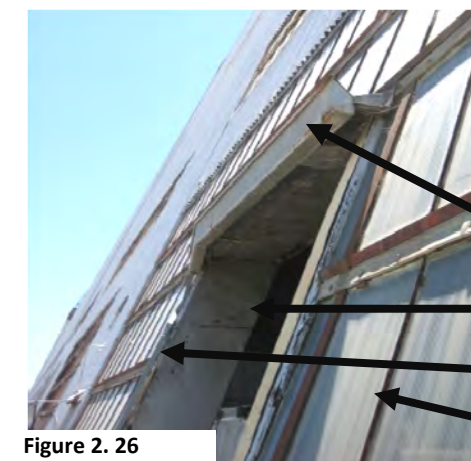

Figure 2.26

downspouts and other miscellaneous components are being removed as part of the Navy's removal action.

- Gutter
- Door Opening
- Downspout
- Flat Glass Windows

2.A.14 Miscellaneous Components and Details – Expansion joints



Figure 2.27



Figure 2.28

There are two major building expansion joints located in Hangar One. These are located at structural grids 4/5 and 10/11. At these locations, two sets of trusses are provided approximately 4 feet apart from each other to allow for movement of the structure. The metal wall panels and built-up roofing stop at the expansion joint and copper/steel flashing details are provided to allow for movement to

occur while keeping moisture from getting inside the hangar. The expansion joints continue across the concrete foundation walls at the base of the hangar exterior (see figure 2.28). The expansion joints augment the thermal expansion capabilities of the metal panel bolt/clip system, which were designed to flex with the movement of the panels.

The expansion joints are in relatively good condition. At the metal siding areas the joint covers have received minor denting. These joint covers have received the various coatings over time and do not have any visible corrosion or deterioration. The metal covers at the concrete base have received more damage over time and are dented and rusted. They will require replacement as part of any future rehabilitation of the hangar exterior.

2.A.15 Miscellaneous Components and Details – Exterior Trenches

Exterior trenches surround the perimeter of the building set within the concrete paving adjacent to the hangar. Along the east and west facades these trenches are covered with steel grating. At the hangar door openings the trenches are covered with steel plates that have two holes in each panel to allow for drainage. The trenches are provided to accumulate water and site drainage and connect into the Base storm water drainage system. Many of the steel covers around the perimeter of the building are broken and damaged and will need to be replaced as part of the Rehabilitation Plan.

2.A.16 Miscellaneous Components and Details – Exterior Structures



Figure 2.29



Figure 2.30

Two existing outbuildings are located along the east exterior façade of the hangar. Building 32 is a two-story structure (see figure 2.29) and Building 33 is a three-story structure (see figure 2.29). These two buildings were originally designed and built to act as observation towers during dirigible take off and landing. The second floor of each building includes a round portion with

retractable metal panels that could be opened to allow for flaggers to direct the dirigibles. These buildings are not currently occupied and are not included within the Navy removal action as they do not contain any of the contaminated metal wall panels that are being removed from the hangar. These two observation buildings are considered to be historically significant when considering the historic value of the hangar as it relates to the period of significance and the operations of the USS Macon.

These two observation tower buildings were not evaluated as part of this report.⁷

2.B General Architectural System Description – Building Interior



Figure 2.31

The original hangar interior was designed and constructed to house support facilities for the USS Macon. These facilities included workshops, storage spaces and special auxiliary apparatuses such as a room originally identified as the "Cell Room," later referred to as the Cork Room due to the 6 inch deep cork walls located along the interior. This room was used to dry the helium cell bags from the USS Macon. Refer to Section 2.E.3 for discussion of archived items, including portions of the Cell Room.

The interior of the hangar is a large open space with the majority of the steel superstructure exposed to view. The original interior construction consisted of two to three story spaces along the east and west sidewalls.

These spaces are commonly referred to as the mezzanine spaces. The remainder of the structure was open and exposed with the horizontal sets of windows allowing natural light to filter into the hangar interior.

Hangar One has been used by multiple military occupants since its original construction. These multiple occupants frequently altered the interior to suit their specific needs and use requirements. This makes it difficult to determine the original layout of the interior hangar spaces. The previously completed Re-Use Guidelines for Hangar One prepared by Page & Turnbull, Inc. dated August 24, 2001 includes a list of the original interior spaces based on historic documentation. This list occurs on page -10- of their report. All interior spaces, offices and partitions have been removed from the building by the Navy.

In addition to the concrete floor of the hangar, there are two mezzanine deck levels located along the building perimeter. The Cork Room was originally located on the upper mezzanine deck level. Portions of the removed Cork Room were salvaged, labeled and turned over to NASA for storage in an artifact storage facility. The condition of these items relative to potential contamination is not known at this time but it is assumed that they have likely absorbed contaminants similar to other materials removed from the hangar interior. The existing framing of the Cork Room has been left in place as part of the Navy's removal action.

An original steam tunnel runs below the hangar at approximately structural grids 7/8 and connects to the boiler room in Building 10, located on Base west of Hangar One. The tunnel runs east-west and extends the full width of the hangar. The top of the steam tunnel aligns with the finish floor elevation of the hangar slab.

Later occupants (post 1950s) and uses of the hangar facilitated the construction of stand-alone single story structures within the hangar that were used as classrooms and office spaces. Some exposed raised

concrete floors (leveling slabs) and curbs are in place today although the rooms have been demolished, by the Navy.

2.B.1 Concrete Floor Slabs

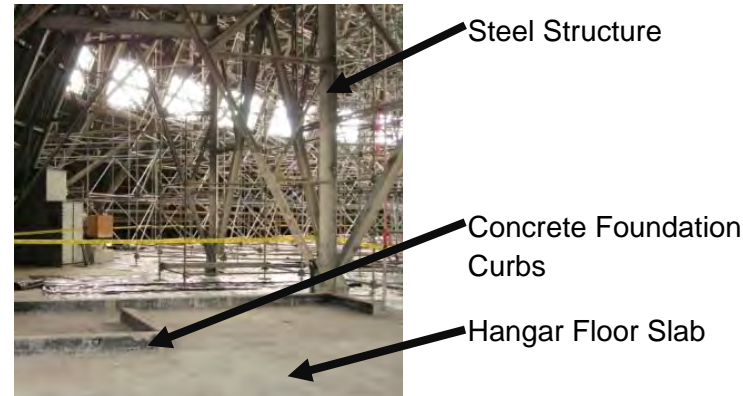

Figure 2.32

The original concrete floor slabs contained multiple tie-downs used for holding the USS Macon in place when housed within the hangar structure. Two standard gauge railroad tracks also ran through the hangar floor and extended both north and south approximately half a mile beyond the hangar doors connecting to mooring circles. A massive mooring mast ran along these tracks and was used to secure the nose of the dirigible to facilitate travel between the hangar and mooring circles.

Based on interior construction and structures that were added for the various occupants of the hangar there are concrete foundation curbs at various locations in the hangar (see figure 2.32). The removal of these curbs is not presently part of the Navy removal action but the curbs would have to be removed as part of any future improvements. Refer also to the structural condition assessment for additional concrete slab information. Two locations of concrete slab within the hangar have been noted during the Navy removal action where the concrete is deteriorating. One location existed prior to the removal action. A third area within the hangar was identified as a potential void space beneath the concrete slab that may have been created during a water main break. The water main break was repaired by NASA and occurred prior to the removal action.

2.B.2 Mezzanine and Upper Levels

The original second floor of the hangar contained office space on the southwest side of the structure. Additional office space was added during World War II along the west side. Along the east side office space was added to the second and third floors during World War II.

Previous demolition along with the ongoing Navy removal action has removed the majority of this construction, including portions of the Cork Room. The existing mezzanine floor deck and steel structure are all that will remain following the completion of the ongoing Navy removal action.

2.B.3 Catwalks and Vertical Access

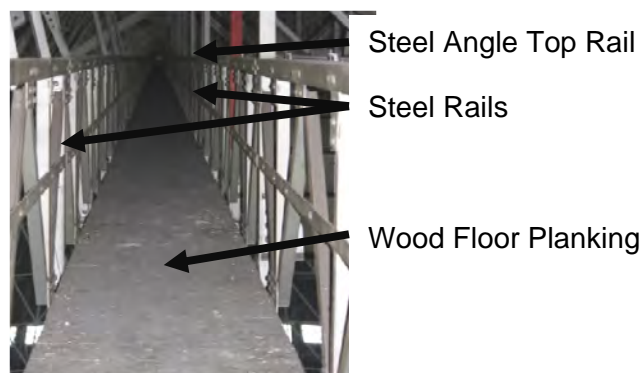

Figure 2.33

A series of stairs, ladders and catwalks provides access between the hangar ground floor and the upper portion of the hangar interior, including access to the outer portions of the roof. The current configuration of railings, specifically the height and/or shape of railings does not comply with OSHA requirements. The stair railings are

approximately 32 inches high with a pipe rail. The catwalk railings are approximately 38 inches high with a 20 inch high intermediate rail. The top of the catwalk railing is a 5 inch wide by 3 inch tall angle.

As part of the ongoing Navy removal action the wood floor planking of the catwalks is being removed as it has absorbed contaminants. The steel components will be left in place and future use will dictate the replacement requirements.

2.B.4 Elevators



Figure 2.34



Figure 2.35

Two elevators were originally installed as part of the original hangar design and construction to facilitate vertical access for one to two persons between the hangar floor and the top of the hangar. These elevators were manufactured by the Otis Elevator Company and operated on tracks that were placed along the structural steel trusses. During travel, the car maintained its vertical orientation while adapting to the curve of the structure along the way. It is not known when the elevators were last fully functional. One of the elevator cabs has been removed and turned over to NASA for storage in a NASA artifact facility. The status and location of the second elevator is currently unknown.

The steel elevator rails are welded to steel angles which are in turn welded to the steel hangar superstructure. There are wood runners spaced periodically (see figures 2.34 and 2.35) that have similar contaminants as the metal panels. These wood runners are being removed as a part of the ongoing Navy removal action. An engineering analysis by Will Design in April 2011 has verified that removal of these wood runners would not adversely impact the steel rail connection to the hangar structure from a vertical load standpoint.

Once the top of the hangar was reached by the elevators, a series of catwalks allowed access to different parts of the upper portions of the hangar. In addition, at the very top of the hangar, interior crane cabs (called man cranes) allowed workers to descend down to access the dirigible and perform work on the exterior. These cabs were connected to overhead cranes that moved along steel runners that are mounted to the underside of the steel hangar roof structure. The cabs and crane components, including the steel rails are being removed as part of the ongoing Navy removal action. All of the man cranes are being salvaged and turned over to NASA.

2.C General Code Related Issues – Code Analysis

Previous Code analysis work has been performed by multiple entities regarding the original hangar design, current condition (prior to the start of the Navy removal action). Potential future uses for the hangar are also identified. The most recent analysis was performed in a 2001 Hangar One Re-Use Guideline report prepared by Page & Turnbull, Inc. Much of the information in the Page & Turnbull report provides the basis for the Code Analysis for this Condition Assessment. As part of that report there is a Code Issues Matrix that is included as Appendix C of this Condition Assessment.

As best defined by the 2010 California Building Code, Hangar One was built in 1932 as a Type VB, non-rated building. The total area of the building is 385,290 square feet and it is 206 feet tall, 312 feet wide and 1,140 feet long. The size of the high bay area is 209,035 square feet. The original use was as a hangar for aircraft. The use of the facility or portions of the facility, as an aircraft hangar continued until 1997 when the Naval Air Reserve left the facility. The existing hangar does not include any type of fire suppression system although there are reports from the contractor performing the Navy removal action that a water line of approximately 8" in diameter extends up the hangar wall to the top of the interior space that may have been used in some manner for fire suppression. Addition of a fire suppression and detection system may be a critical factor in developing the hangar for any potential future uses depending on occupancy and will require detailed analysis by a fire protection engineer. Although not comprehensive, limited analysis based on general assumptions will be provided with the Rehabilitation Plan.

The major deficiency of the hangar when analyzed to current building codes, aside from the lack of fire suppression systems, is the lack of adequate egress and egress travel distances. Aside from future re-use as an aircraft hangar the most commonly recommended use is based on an assembly occupancy. It is this high occupant based occupancy that would lead to system upgrades to bring the hangar up to relative compliance with current codes. The current applicable code is the 2010 California Building Code with a potential updated version in 2012. Any future re-use would require a full analysis of the current Code at time of design, and coordination with California State Historic Preservation Office (SHPO) regarding any proposed modifications. Additionally, the 2010 California Building Code is written and intended for new construction projects. Any analysis of Hangar One based on current Code compliance should take into consideration that a relative or equivalent level of safety be maintained while at the same time working to restore the historic significance or value of the hangar. In situations where Code compliance would adversely impact the historic significance, alternatives, such as the California Historical Building Code, should be considered to both maintain the historic significance while providing an equivalent level of safety in the eyes of the Code.

2.C.1 General Code Related Issues – Fire Risk Analysis

NASA Ames Research Center prepared a preliminary fire risk analysis that is included with this Condition Assessment as Appendix N. This Fire Risk Assessment states the case for occupancy of the building as a hangar with the provision of basic fire protection measures. These include a dedicated fire detection system, removal of interior sources of combustible materials during the rehabilitation of the hangar's interior areas, controls of handling fuel, cryogenics, and operational procedures for reducing hazard effects.

2.D General Historic Preservation Issues - Architectural

Hangar One had multiple occupants and uses over the course of its life. The primary period of significance is between 1932 and the end of World War II in 1945. This time period characterizes the initial design and construction of the hangar with the original use by the Navy and ends with its use by the Army during World War II. There is an existing California Historical Civil Engineering Landmark Plaque that was installed on the sloped concrete foundation wall on the east-northern side of the hangar. This plaque will be preserved and protected during the ongoing Navy removal action.

Based on the established period of significance, the following character defining features have been identified. Selection of appropriate uses, treatments and modifications must be sensitive to these particular features and qualities to protect the historical integrity of the hangar structure.

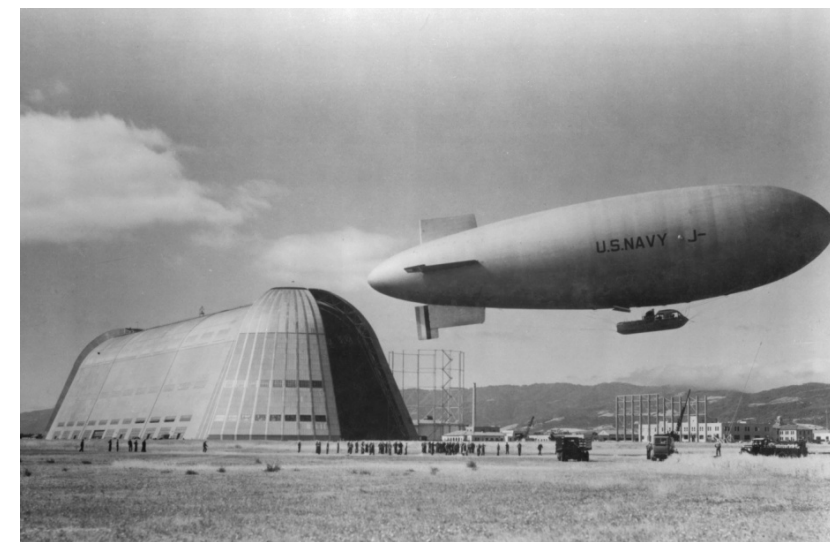

Figure 2. 36

These features include:

- The Streamline Moderne form and design
- The vast open interior area
- The “clam shell” or “orange peel” hangar doors
- The exterior metal panel skin system, both the V-Beam and Mansard siding profiles
- The exterior corrugated wired windows, steel frames and steel mullions
- The exterior built-up roofing system
- The horizontal strip window systems, both corrugated and flat profiles
- The exterior metal drainage grating around the perimeter of the hangar
- The metal tie-down rings for the USS Macon
- The original observation and control towers – Building 32 and Building 33

As a result of changes in occupancy and use of Hangar One following the period of significance, aside from the exposed structural steel components it is difficult to fully date changes to the interior configurations. Therefore, it is also difficult to comprehensively determine the character defining interior features of the structure. Additionally, potential future uses of the hangar may be limited by restoration of the interior to its pre-World War II state. Because most of the interior rooms have been removed during Navy removal action, this report is primarily concerned with the exterior features of the building. The interior features will be addressed with more detail as part of the Rehabilitation Plan as they pertain to re-skinning the building, re-using the building as a hangar and/or potential non-hangar future re-uses of the building.

2.D.1 Hangar One Context Within Shenandoah Historical District



Figure 2. 37

Hangar One currently is the centerpiece of the Shenandoah Historic District. In 1994, the US National Park Service nominated the District for recognition. Additionally, Hangar One is individually eligible to be included on the *National Register of Historic Properties*. As a contributing building to the historic district, Hangar One is entitled to the following district-wide treatments:

1. Recognition that the property is of significance to the nation, state and community
2. The property is eligible to utilize the California Historical Building Code
3. Federal or federally assisted projects are subject to Section 106 Review
4. The property may be eligible for Federal Historic Preservation Tax Credits
5. The property is qualified for Federal grants for historic preservation, when funds are available



Figure 2. 38

As a resource individually eligible for listing on the National Register of Historic Places, Hangar One must be considered both as an important contributor to the historic district, as well as for its unique historical value. A previous study performed by Page & Turnbull, Inc. on the historic significance of Hangar One has determined it's eligibility for the National Register under Criterion A – Historic Patterns of Events under the Military and Historic Design/Construction category. A full account for this determination is made in the report and is referenced in Appendix A of the Condition Assessment.

2.D.2 Current As-Built Documents, Existing Documentation and Resources

Numerous reports, drawings, documentation and resources have been created to date regarding Hangar One. Many of these have been used in compiling this Condition Assessment and/or are referenced herein. These documents include but are not limited to the following:

The HAER (Historic American Engineering Report) Documents

Hangar One Historic Engineering Record, #CA-335
 Contemporary Photography of Hangar One's Structure
 Original Architectural Drawings of Hangar One
 Restoration Drawings of Hangar One

Hangar One Re-Use Guidelines, prepared by Page & Turnbull, Inc.

Hangar One – As-Built Documentation, prepared by AECOM

<http://historicproperties.arc.nasa.gov>

NASA's Hangar One Re-Siding Project, prepared by Office of Inspector general (016), Office of Audits

Hangar One Architectural Facade Study, prepared by AECOM

Existing Hangar One As-Built Drawings

Please see the provided bibliography (Appendix A) for a complete listing of resources.

2.D.3 Potential Re-Use of Redwood Decking

As part of the ongoing Navy removal action, the existing redwood decking that serves as underlayment for the built-up roofing and Mansard siding is being removed. The contractor performing the work has proposed to salvage the material (a small percentage of the decking along the sides of the hangar as well as the decking at hangar doors is not salvageable), plane it to "clean" the contaminants, and sell it. This potential solution will be further discussed in the Rehabilitation Plan.

2.D.4 Summary of Historic Documentation and Previous Preservation Efforts

Multiple preservation efforts have been undertaken in the recent history of Hangar One. As part of these efforts options have been considered by the Navy as how to re-skin the structure following removal action to remove all contaminated or potentially contaminated materials. Some of the previously considered and analyzed re-skinning efforts include:

1. Cover the existing hangar panels with a rubberized material
2. Coat the existing hangar panels with an acrylic coating
3. Cover the hangar with new, visually similar metal panels
4. Remove the contaminated siding and coat the remaining, exposed structure surfaces
5. Completely demolish and remove the hangar

As a short term solution the Navy installed a fluid-applied coating to the exterior of the hangar intended to contain the slow release of contaminants into the surrounding areas. In addition there is an ongoing removal action that is being executed by the Navy that is removing and disposing the exterior skin and contaminated exterior/interior materials. The remaining structure and hangar components will receive an

application of a modified aluminum epoxy mastic coating intended to protect exposed components from weathering and corrosion. In addition the applied coating is intended as a protective layer to any potentially remaining contaminants left in the originally applied paint coatings on the structural components. The specific Navy removal action and the modified aluminum epoxy mastic coating are discussed further later in this Condition Assessment.

As part of this Condition Assessment and Rehabilitation Plan, recommendations will be provided regarding re-skinning the hangar to restore its appearance during its period of historic significance. Additionally, this study will include cost estimates and potential future uses as part of the Rehabilitation Plan. There are some challenges that will be present in this effort. These challenges include:

1. The two existing metal panel profiles do not appear to be readily available, off the shelf manufactured standard profiles. Many metal panel manufacturers can make custom panel profiles to match but will likely carry a substantial setup cost in order to manufacture
2. The existing window systems are industrial window frames that consist of built-up steel brackets and angles. These will require custom fabrication in order to match the intended visual aesthetic of the hangar
3. The corrugated glazing will require custom manufacture and will bear the associated costs in order to match the indented profiles
4. The original metal panel sizes are approximately 30 inches wide by 9 feet tall. Reapplication of panels in the same or similar size would require large amounts of labor costs in order to retrofit approximately 650,000 square feet of surface area. The Rehabilitation Plan will analyze potential options for installation of siding systems in order to limit installation costs while maintaining the intended historic visual aesthetic
5. The hangar doors will require maintenance and service, in addition to the replacement of at least one motor, in order to bring them back into a fully functional condition. The replacement of any motors will require that they carry the same visual aesthetic of the existing motors
6. Potential structural Code upgrades likely will require the addition of new structural steel members to the existing steel structural systems. This might have an impact on both the visual and re-skinning detailing requirements during rehabilitation

2.E Current Work

2.E.1 Summary of Ongoing Navy Removal Action

The Navy currently has a contract with AMEC to perform the ongoing removal action. CH2M HILL conducted an on-site survey on July 25 and 26, 2011 to observe the ongoing work and survey the condition of the hangar. Conditions observed during that survey include:

1. Scaffolding was in place at the south half of the hangar on the interior to access the structure from the inside. This scaffolding was being used to prepare the steel and apply the special coating
2. Portions of the metal panels at the tops of the exterior of the south hangar doors were being removed and disposed of. These panels were being accessed from/by overhead cable suspended scaffolds
3. Most interior construction, namely the Cork Room (with exception of the Cork Room frame) and interior offices and class rooms had already been removed

4. All interior lighting and electrical service to the building had been removed or were in the process of being removed. The electrical vaults remain

2.E.2 Description of Archived Components

Various components and materials are being removed from Hangar One as part of the Navy removal action and turned over to NASA as artifacts for safekeeping and storage. These items vary from the elevator cab and Cork Room finishes previously noted in this Condition Assessment to flight equipment, corrugated windows (approximately 25 windows will be removed and salvaged), display cases and office furniture. NASA maintains a release and transfer form to track these artifacts. A current copy as of the time of writing this Condition Assessment of the Hangar One Historic Items Release and Transfer Form is included as Appendix E.

2.E.3 Description of Site Utility Conditions

As a part of the ongoing Navy removal action utilities to the building are being removed and capped at various locations outside of the hangar footprint. These utilities include:

- Telecommunications
- Electrical Distribution
- High Pressure Air Systems
- Natural Gas Distribution
- Sanitary Sewer
- Steam Tunnels
- Storm Drain
- Water Distribution

The Navy and NASA Ames Research Center has provided drawings showing the extent locations for each of the utility systems noted above. These drawings are included as Appendix D to this report.

2.E.4 Beacon Access (as defined by Navy scope of work)

The beacon is a roof-mounted light on a raised platform required due to the hangars location adjacent to the Moffett Field runways. The beacon will remain operational prior to, during and following the Navy's removal action. As a part of their scope of work they will be providing permanent access to and a permanent power source to keep the beacon light operational.

2.E.5 Discussion and Analysis of Carboline Carbomastic 15 Steel Coating Product

As part of the ongoing Navy removal action a protective coating is being applied to all of the remaining structural steel components to protect the exposed components from weathering and corrosion. The coating is intended to be non-combustible, weather resistant, and is to provide a protective coating on the lead primer and any PCB's remaining on the steel structure. The coating will also closely resemble the color of the existing hangar metal siding. Any new steel framing being added, as well as the second floor steel plate flooring are to receive this coating.

Based on analysis of the Coating Condition Survey and the Carbomastic 15 data sheet (see figure 2.39) performed as part of this Condition Assessment the coating being used is a suitable product for this type of requirement. As with all coating systems of this type it is critical to the long term performance of the coating that the substrate is properly prepared. The specified surface preparation is in accordance with the Society of Protective Coatings (SSPC) SP-12 Low Pressure Water Cleaning to a WJ-3 cleanliness at 3,000 to 4,000 psi. Certain areas with more significant coating are specified to receive the water cleaning with a "Roto Head" and pressures between 5,000 and 8,000 psi. The contractor has decided to use the "Roto Head" for all areas of water cleaning. In addition, due to substantial rusting and deterioration of the mezzanine deck, these surfaces will undergo additional surface preparation prior to coating. All of the existing contaminated paint, mill scale, and rust will be completely removed from the mezzanine deck to "near white metal condition" prior to coating with a primer (Carbozine 859) and finish coat (Carbomastic 15).

The coating is applied at 4 mils minimum dry film thickness while the skin is still attached. The coating is typically spray applied; however, rivets and other unique features, such as beam connection and lattice steel, are also coated with a brush. Because the skin is still attached there are multiple inaccessible areas. Once the skin is removed, the coating will be applied to previously inaccessible areas. After all demolition and construction is complete, all surfaces will be touched up as needed.

The painting activities are being checked for quality assurance and quality control (QA/QC) in several different ways. The first method is the use of a wet film thickness gauge used by the painting applicator during application. The next method is a dedicated QA/QC staff employed by the painting subcontractor. This QA/QC person measures original paint thickness, judges surface preparation and cleanliness, and compares final dry film thickness measurements to the originals to verify the correct thickness is achieved. In addition, the general contractor is also providing QA/QC and the Navy representatives are conducting regular QA inspections in accordance with the Site-Specific Construction Quality Control Plan. Lastly, the paint manufacturer's representative was originally on site approximately once per week to verify the application and surface preparation but has switched to periodic inspections at their discretion.

It is not expected that the structure will remain in its un-skinned condition longer than ten years. However, if that is the case there will be periodic maintenance and scheduled reapplication of the protective coating in order to mitigate any adverse impacts of weathering and corrosion as well as ensure for adequate protective covering of the existing structures by the Navy. The coating manufacturer will warrant the application associated with the removal action for 12 years with 2% degradation and recommends periodic inspection every 3 years. As part of the Rehabilitation Plan we will further discuss these manufacturer recommendations with additional inspection recommendations and maintenance requirements.

product data



Carbomastic® 15
& Carbomastic 15 FC

Selection & Specification Data

Generic Type	Modified aluminum epoxy mastic
Description	Aluminum-pigmented, low-stress, high-solids mastic with outstanding performance properties and proven field history. Carbomastic 15 was the pioneer mastic coating in a number of industrial markets and today still provides unmatched levels of barrier protection and corrosion resistance over existing finishes and rusted or SSPC-SP2 or SP3-cleaned steel.
Features	<ul style="list-style-type: none"> ▪ Excellent performance over minimal surface preparation of steel substrates ▪ Suitable as a topcoat for most tightly adhered existing coatings ▪ Excellent choice for field touch-up of zinc-rich primers and galvanized steel ▪ Unique formulation with aluminum flakes provides exceptional barrier protection ▪ May be applied at 35°F (2°C) when CM 15 FC's part B is utilized. ▪ Suitable for use under insulation on hot surfaces operating up to 300°F (150°C) ▪ VOC compliant to current AIM regulations
Color	CM 15: Aluminum (C901); Red (M500)* CM 15 FC: Aluminum (C901); Red (M500)* Color variations within a batch and from batch-to-batch may occur due to the metallic pigments and variations in application techniques and conditions. Neither product is color matched, nor will they match each other. (15 FC may have a greenish appearance.) *Red (M500) is available for use as a contrasting primer in multiple coat applications, but should always be topcoated.
Primers	Self-priming. May be applied over most tightly adhering coatings as well as inorganic zinc primers. A mist coat may be required to minimize bubbling over inorganic zinc primers.
Topcoats	Acrylics, Alkyds, Epoxies, Polyurethanes
Dry Film Thickness	3.0 mils (75 microns) over existing coatings and 5.0 mils (125 microns) minimum on rusted steel. 7.0-10.0 mils (175-250 microns) in one or two coats for severe exposures. Do not exceed 10.0 mils (250 microns) in a single coat.
Solids Content	By Volume: 90% ± 2%
Theoretical Coverage Rate	1444 mil ft ² (36.0 m ² /l at 25 microns) 288 ft ² at 5 mils (7.2 m ² /l at 125 microns) Allow for loss in mixing and application
VOC Values CM 15 & CM 15 FC	As supplied: (CM15) 0.7 lbs/gal (88 g/l) (CM15FC) 0.8 lbs/gal (97 g/l) Thinned: (values are for CM15) 32 oz/gal w/ #75: 1.9 lbs/gal (231 g/l) 32 oz/gal w/ #10: 2.0 lbs/gal (242 g/l) These are nominal values.
HAPS Values	As supplied: (CM15) 0.70 lbs/solid gal

Temperature Resistance	Under Insulation: 300°F (150°C) Discoloration is observed above 180°F (82°C) but does not affect performance.
-------------------------------	------------------------------------------------------------------------------------------------------------------

Substrates & Surface Preparation

General	Surfaces must be clean and dry. Employ adequate methods to remove dirt, dust, oil and all other contaminants that could interfere with adhesion of the coating.
Steel	Immersion: SSPC-SP10 with a 2.0-3.0 mil (50-75 micron) surface profile. Non-Immersion: SSPC-SP6 with a 2.0-3.0 mil (50-75 micron) surface profile for maximum protection. SSPC-SP2, SP3, SP7, or SP12 are also acceptable methods
Galvanized Steel	For optimum performance sweep blast cleaning is recommended. Consult your Carboline Sales Representative for specific recommendations.
Previously Painted Surfaces	Lightly sand or abrade to roughen and degloss the surface. Existing paint must attain a minimum 3A rating in accordance with ASTM D3359 "X-Scribe" adhesion test.

Performance Data

Test Method	System	Results
ASTM D522 Flexibility	Blasted steel 1 ct. CM 15	A) Conical - crack 0.38" actual elongation 48.57% B) Cylindrical- no cracking observed
ASTM D4060 Taber Abrasion	1 ct. CM 15	89.8 mg per 3000 cycles CS 17 wheel, 1000 gm load.
ASTM G14 Impact Resistance	A) Blasted steel 1 ct. CM15 B) Rusted steel 1 ct. CM15	Area damaged: A) 1/4 inch (0.25") B) 1/4 - 9/16 inch (0.44")
ASTM B117 Salt Spray	Rusted steel 1 ct. CM 15	No blistering, rusting, or softening No rust creep from scribe
ASTM D1735 Water Fog	Rusted steel 1 ct. CM 15	No blistering or softening No creep from scribe

Test reports and additional data available upon written request.

December 2010 replaces October 2010
0185

Figure 2.39

3.0 Structural Condition Assessment

3.A General Structural System Description

Hangar One's structural system is an elegant combination of structural steel arched trusses and braced frames. The arched trusses are supported on "A" shaped frames which transfer loads into the pile foundation system. There are 14 trusses along the length of the building at 72 feet on center spacing and 2 gable arches at 40 feet from the main arches at each end. The building is separated by two 4 foot expansion joints between arches 4 and 5 and 10 and 11, structurally dividing the building into three separate sections.

The structure is in generally good condition. There are no obvious signs of structural distress, and there is no apparent evidence of previous building damage from either wind or seismic events. During the course of the Navy's removal action several structural repairs were completed, see section 3.G.

3.A.1 Arched Trusses

The arched trusses consist of built up "I" shaped sections consisting of I beams and channels. All of the sections are riveted together continuously along the length of the member. The primary truss chords are made of silicon steel and the truss webs and other members are made of carbon steel. The trusses have both top and bottom chord bracing which typically consists of double angles. There are space frame trusses between the arched trusses which transfer gravity and lateral loads to the primary arches.

3.A.2 "A" Frames

The "A" frames consist of built up "I" shaped sections consisting of I beams and channels. All of the sections are riveted together continuously along the length of the member. The "A" frames have a pinned connection at the top which provides an effective means of ensuring the arched trusses act as a simply supported member. The "A" frames support the arched frames at an elevation of 55 feet above ground and connect to the arched trusses with a 6 inch diameter pin. The "A" frames sit on pile groups which transfer lateral and gravity loads into the soil. The "A" frames have horizontal and vertical trusses between them which transfer gravity and lateral loads into the primary frames.

3.A.3 Lateral System

Transverse Direction

The lateral loads are resisted by the main arches, which then transfer the load to the "A" frames. The trusses (V-braces and H-braces) between the arches act as a diaphragm in transferring the lateral loads to the main arches. The "A" frames are supported on piles. Some of the piles are battered and internal concrete tie beams are provided below the slab on grade for supporting the horizontal reaction of the building and tying both sides of the building together.

Longitudinal Direction

The bracing members between the "A" frames (exterior and interior faces) resist the lateral loads and the arches and the V and H bracings between the arches act as a diaphragm transferring the lateral loads to

the top of the "A" frames. The bracing between the main members is provided by single angles and double angles in several different configurations.

3.A.4 Wind Girts

The wind girts span horizontally between the primary arched trusses and "A" frames. They are supported at intermediate points by the space frame trusses in the arched portion of the building at nine feet on center and in the "A" frame portion of the building at approximately ten feet on center. The wind girts are channels with the strong axis oriented horizontally and are located at approximately 7 feet -6 inches on center. On the upper portion of the building, the girts are oriented vertically and are spaced at approximately 9 feet -0 inches on center.

3.A.5 Siding

The siding is constructed of corrugated steel. The siding only transfers vertical and lateral loads to the wind girts. The siding does not act as a diaphragm. The siding on the lower portion of the building is connected directly to the wind girts. In the upper portion of the building, wind girts are oriented vertically and have 2x6 redwood planks which span between the vertical steel members. The siding is continuously supported by the redwood planks which then transfer loads to the vertical girts.

At the time of this condition assessment, the majority of the siding is in place, but portions of it have been removed as part of the Navy's removal action. All of the siding will eventually be removed.

3.A.6 Doors

Hangar One's doors are enormous clamshell or "orange peel" type doors which open horizontally. One door consists of two leaves made up of structural steel ribs that open outward from the center. The doors are supported at the bottom on railroad trucks which travel on curved rails. At the top, the doors are supported by a large pin which transfers horizontal loads to the trusses on grid lines 1 and 14. Each door leaf weighs approximately 600 tons.

3.A.7 Concrete Walls

Hangar One has a low perimeter wall along the straight sides of the hangar. The siding attaches to the top of the concrete wall. There is a new opening on the east side of the hangar wall that was created after the original construction of the hangar. The opening was saw cut into the concrete and the metal siding at the opening was removed to approximately the first wind girt elevation. The new opening does not affect the structural capacity of the building. There are also 11 new man doors that over the years have been introduced into the hangar walls. The concrete perimeter wall was removed at these locations to allow the door placement.

3.A.8 Structural Steel Materials

The typical structural steel grade used in the construction of Hangar One is A7 Grade 30. This is a common structural steel grade for building construction at the time. An article written in 1929 (Higley, 1929) about a similar hangar designed by the same engineer indicates that the chords of the arched trusses are silicon steel which typically had a 45ksi yield strength. Future testing of the steel may prove that a grade 45 steel was actually used and reduce the amount of retrofits to the primary chords. This could be included as part of a value engineering effort during the final design.

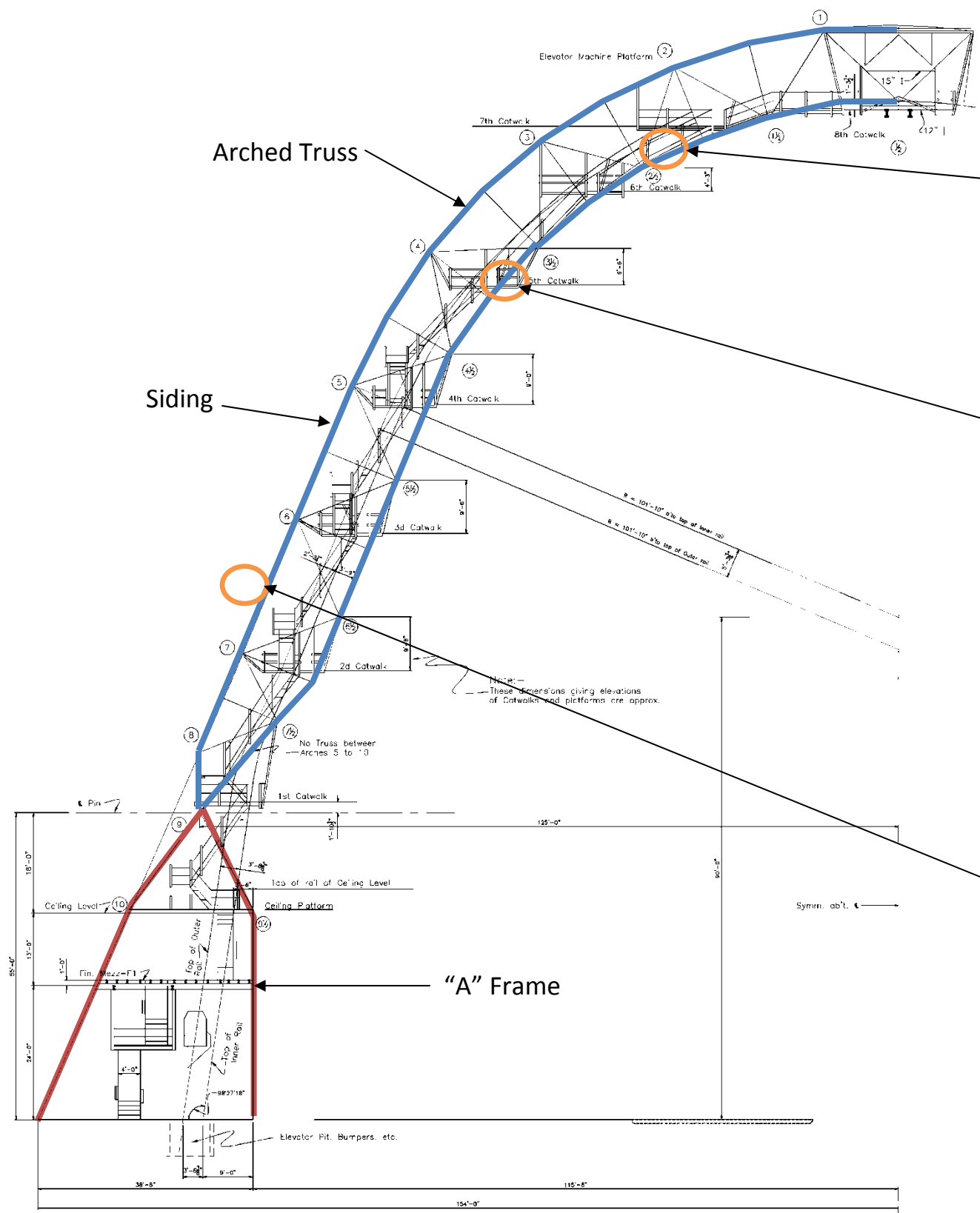

Figure 3-1: Typical Transverse Building Section

Figure 3-2: Stairs Between Catwalks



Figure 3-3: Catwalk @ 8 Locations



Figure 3-4: Wind Girt @ 7'-6" O.C.



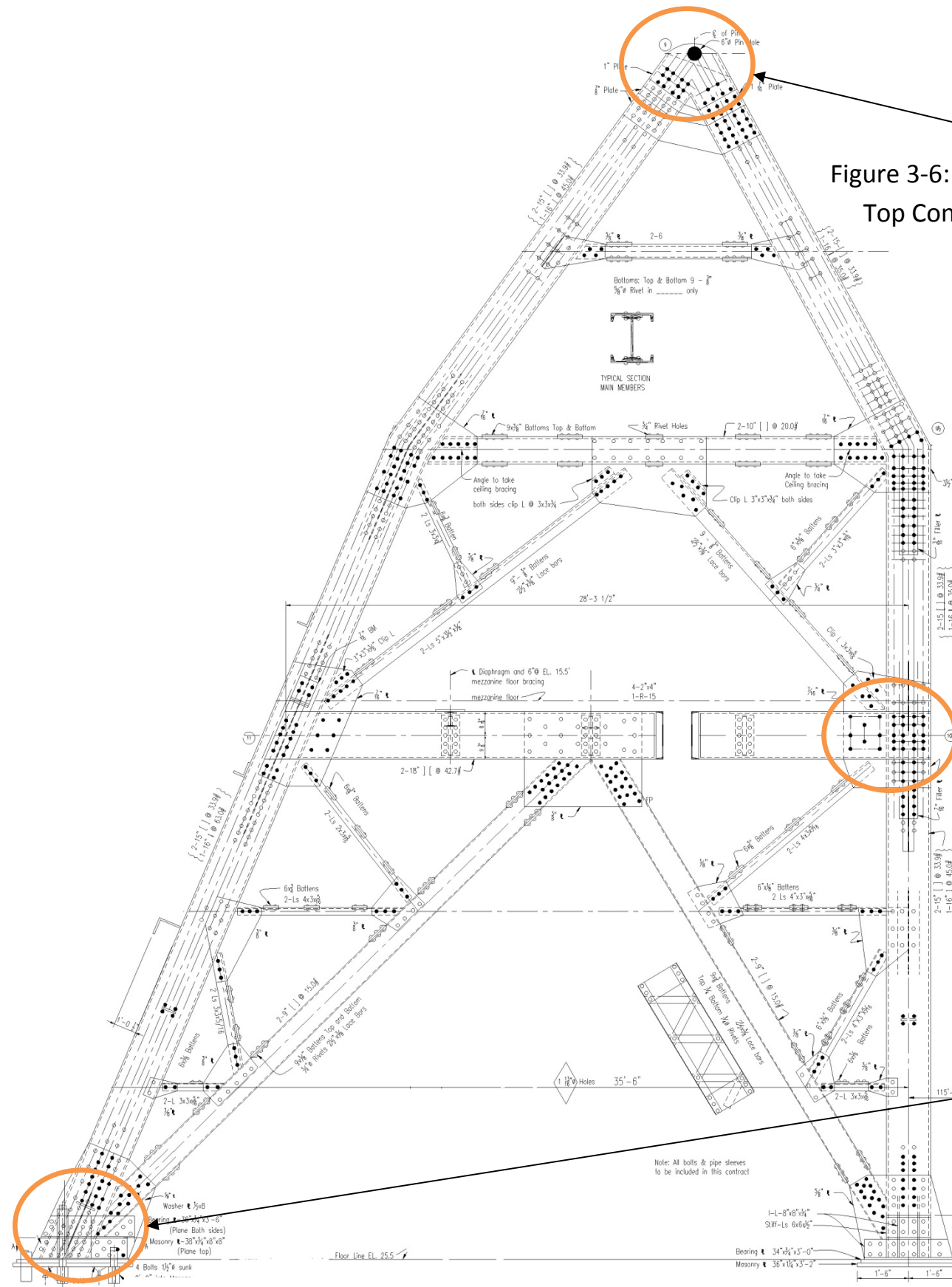

Figure 3-5: Typical "A" Frame

Figure 3-6: "A" Frame Top Connection

Figure 3-7: Connection at Mezzanine

Figure 3-8: Base Plate

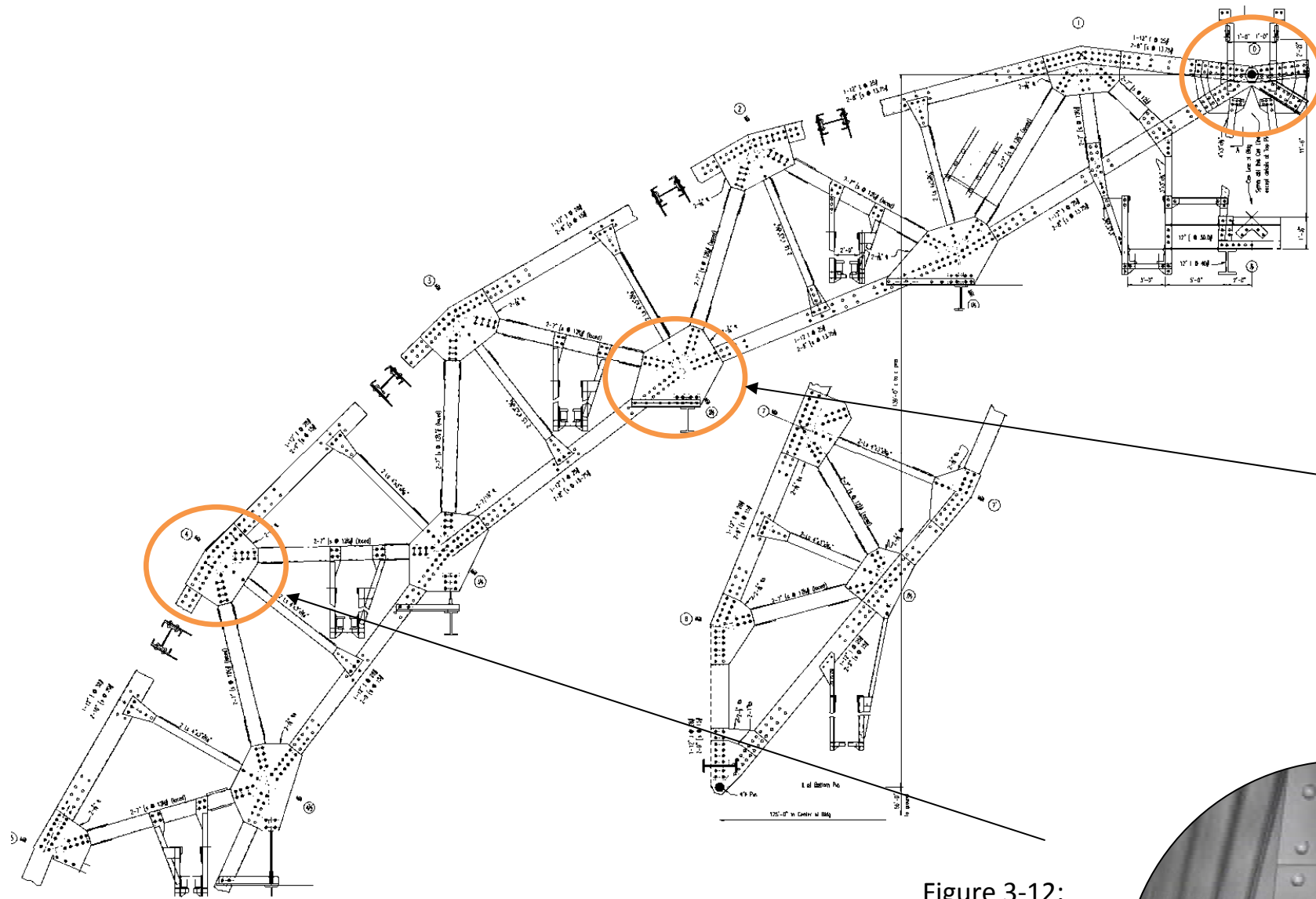

Figure 3-9: Typical Arched Truss

Figure 3-12:
Top Chord
Connection

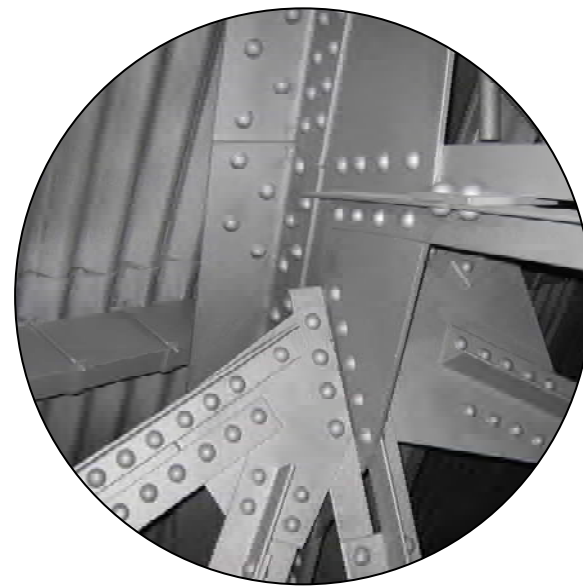

Figure 3-10:
Arch Top
Connection

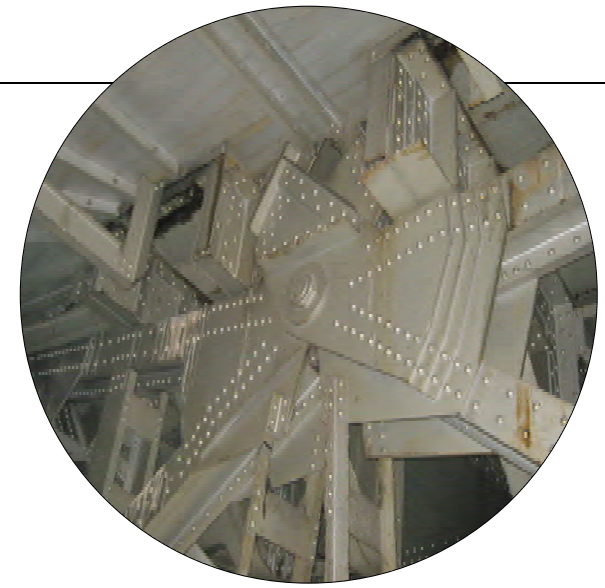

Figure 3-11:
Bottom Chord
Connection





Figure 3-14: Corrosion at Gabled Frame Framing Below Window.



Figure 3-15: Corrosion at Wind Girt Below Window

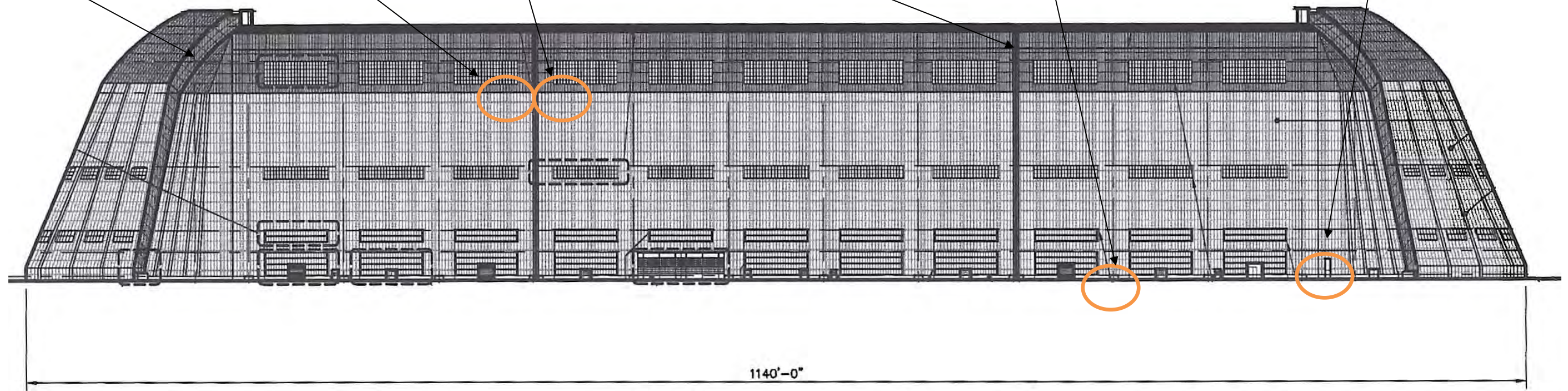

Figure 3-16: Concrete Wall at Hangar Perimeter, From Inside



Figure 3-17: New Opening

Expansion Joint



HANGAR ONE - EAST ELEVATION

Figure 3-13:

1140'-0"

3.B Foundation System

The foundation consists of pile groups at each of the "A" frame columns. The pile groups support both the gravity and lateral loads.

3.B.1 Piles

Hangar One utilizes pre-cast concrete piles. The pile groups typically have 13 piles at the exterior columns of the "A" frames and 10 piles at the interior columns of the "A" frames. The piles are 16 inches square and 35 feet long. The pile caps are typically 4 feet thick (reference drawing M4-0001-S35). The Geotechnical Report, Section 5, identifies pile capacities.

3.B.2 Slab on Grade

The un-reinforced slab on grade is 8 inches thick in the center portion of the hangar and 6 inches thick in the outer portions of the hangar (reference drawing M4-0001-C2). The 8 inch portion of the slab can support an approximately 700 psf stationary live load or a 4000 pound to 6000 pound capacity forklift. The 6 inch thick portion of the slab can support an approximately 600 psf stationary live load or a 3000 pound capacity forklift. It is also capable of supporting limited semi truck traffic. These slab capacities should be considered preliminary. Actual slab capacities depend on the actual concrete strength and the condition of the subsoil.

3.B.3 Interior Structure Foundations

The original hangar had multiple ancillary rooms underneath the "A" frames. The rooms were typically founded on cast in place concrete stem walls with continuous footings.

There were multiple structures that were added to the interior of the hangar throughout its life. The typical interior structure foundation is a cast in place concrete curb doweled into the slab on grade (see figure 3-19). The buildings have been removed as part of the Navy's removal action, but the concrete curbs remain in place. The removal of the buildings does not affect the hangar's structural integrity.

3.B.4 Geotechnical Report

The geotechnical report (see Section 5.0) identifies a liquefaction hazard at Hangar One and states that in-situ soil improvements are necessary for Options B through E.

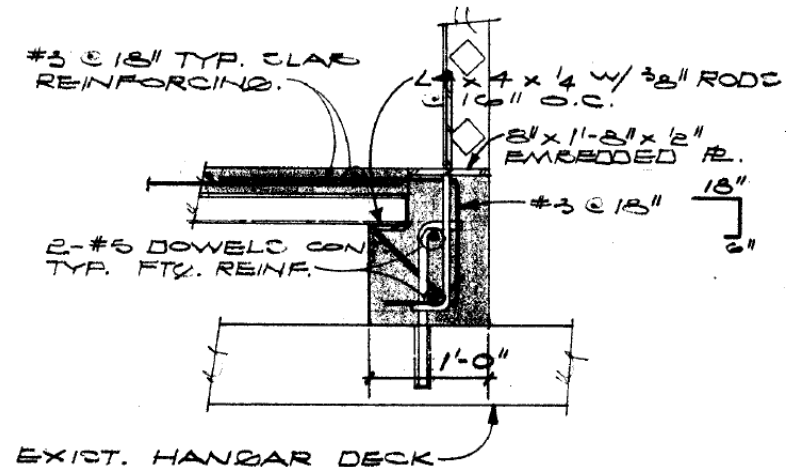

Figure 3-18: Example Interior Building Foundation: Reference Drawing M4-0001-S67

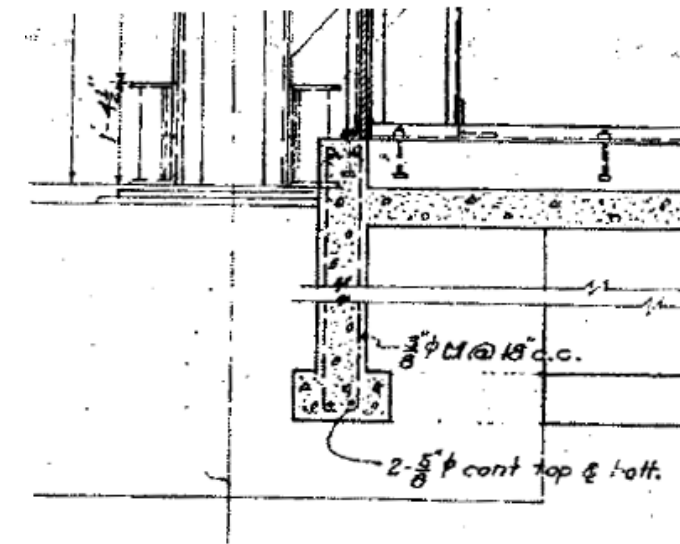

Figure 3-19: Original Interior Room Foundation: Reference Drawing M4-0001-S58

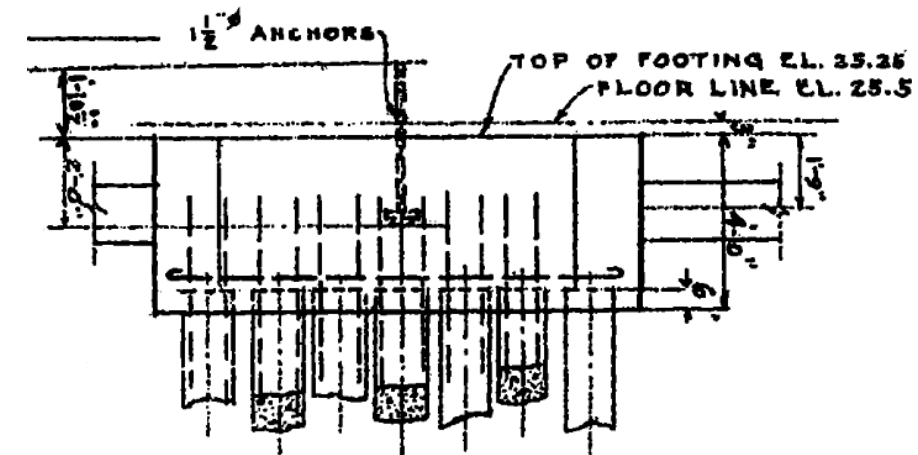

Figure 3-20: Pile Cap

3.C Connections

Hangar One's connections typically utilize gusset plates with rivets. The rivets are typically 7/8 inch diameter and appear to be in excellent condition. New members installed by the Navy utilize bolted connections.

3.D Wood Members in the Structure

Hangar One uses redwood boards extensively throughout the structure. All of the wood members will be removed from the structure as part of the Navy's removal action. The redwood has surface contamination of hazardous materials and is being removed as part of the Navy's removal action.

One issue with the replacement of redwood in the structure with in-kind materials is the flammability of redwood. The use of a fire-retardant treatment on the wood may alleviate those concerns but will require agreement with the fire official.

3.D.1 Wood Decking at Hangar Exterior

The entire upper 1/3 of the structure has 2x6 tongue and groove redwood decking which spans between vertical wind girts. The redwood transfers lateral loads to the vertical wind girts and continuously supports metal decking which is attached to its outside face. The redwood decking is being removed from the hangar as part of the Navy's removal action. Similar wood decking or another equivalent horizontally spanning structural element will need to be placed between the vertical girts upon re-skinning in order to transfer loads to the structure.

3.D.2 Wood Decking at Catwalks

The catwalk walking surfaces are also constructed of redwood decking. The redwood provides the structural decking for the catwalk system. Its removal renders the catwalk system un-usable until the catwalks are re-decked with a suitable replacement.

3.D.3 Wood at Elevators

The elevator system uses redwood ties to support the rails and a redwood center rail that apparently guides the elevator cab. The wood members at the elevators would need to be replaced if the elevators are to be made functional again.

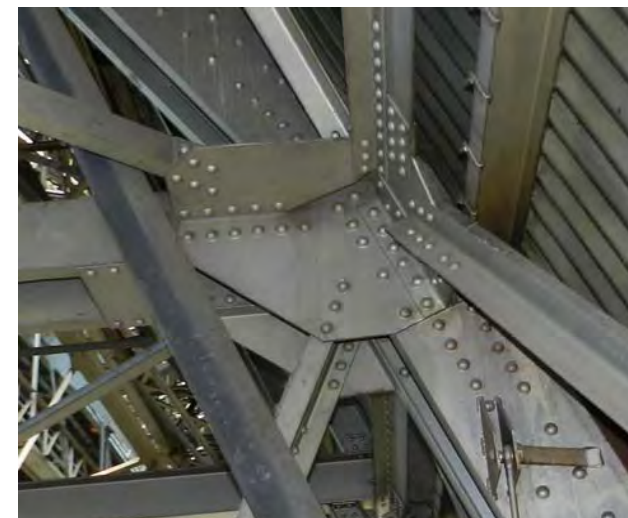

Figure 3-21: Example Gusset Plate with Rivets

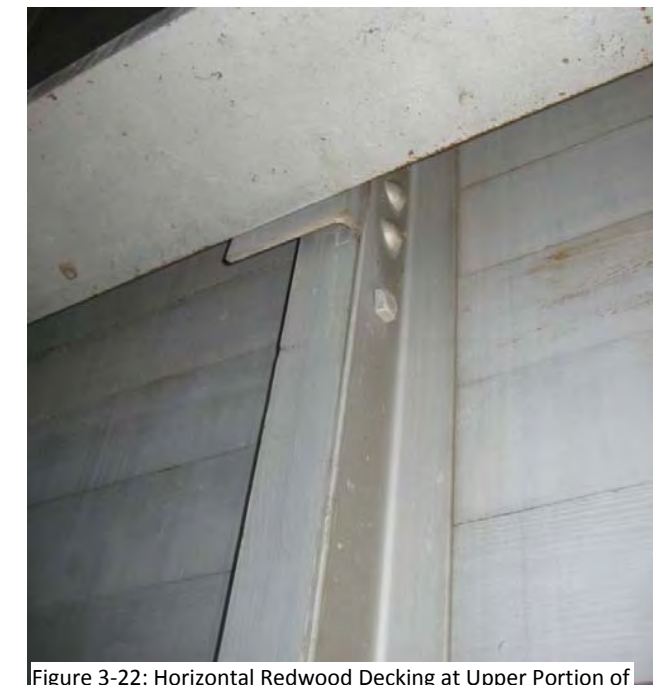
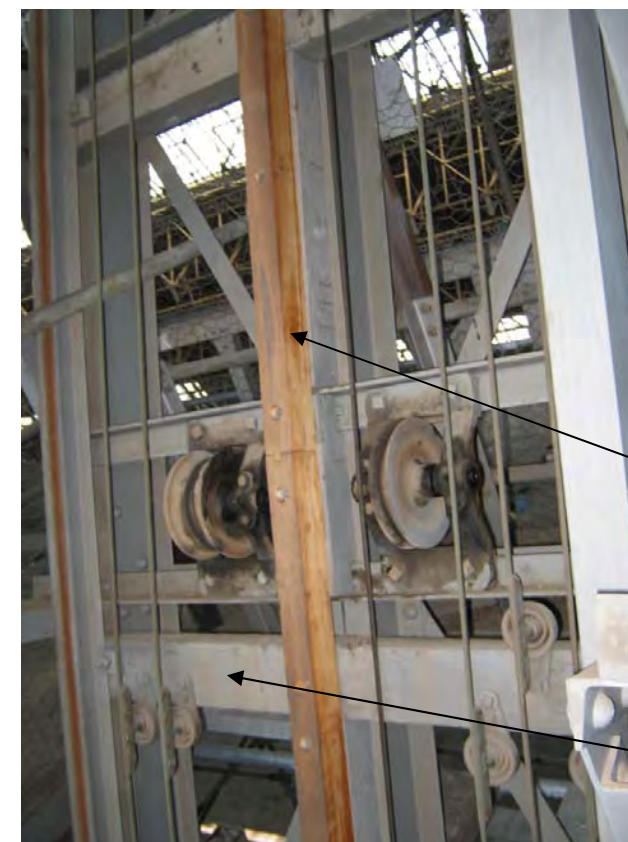

Figure 3-22: Horizontal Redwood Decking at Upper Portion of Hangar



Wood Center Rail

Wood Tie Supporting Rails

Figure 3-23: Wood Members at Elevator

3.E Catwalks and Stairs

Hangar One has an extensive network of stairs and catwalks around the interior face of the hangar walls. The catwalks typically span 18 feet between supports and appear to be a truss where the catwalk handrail is a stressed member which carries gravity loads. The catwalk handrail is typically an angle, although portions of the handrail are round tube (reference drawing M4-0001-A38).

3.F Condition of Existing Members

3.F.1 Typical Structural Members

The typical structural members are in excellent condition. They have little to no rust and appear to have no distress.

The members around windows have been exposed to more moisture than those away from windows and as such have more corrosion. The corrosion around windows appears to be limited to surface rust and does not appear to have penetrated too deep into the steel. The coating being applied as part of the Navy removal action is designed to be applied over light rust. If any heavy rust is encountered, it should be removed prior to applying the coating.

3.F.2 Connections

The connections appear to be in excellent condition, there appears to be little or no rust on the connections. The rivets appear to be in good condition, and there are no obvious gusset plate deformations.

3.F.3 Condition of Door Mechanism

The door mechanisms were reportedly in working order in 2001. The door trucks have small amounts of surface rust, but no obvious broken pieces. Each door leaf has an electric motor which powers the doors. When the doors were last operated, one of the four motors was missing. See sections 2.A.6 and 2.A.7 for additional discussion on the hangar doors.

3.F.4 Concrete

The concrete hangar slab generally appears to be in good condition. The slab is only a maximum of 8 inches thick which, depending on the re-use option, this may be too thin to support very large structural loads. The hangar slab is also fairly rough and irregular, and, depending on the re-use option, may need to be replaced with a smoother, stronger slab. The actual required capacity of the slab will not be known until a re-use option is selected. There are also two newly reported sunken areas of the slab, one of which was reportedly caused by the Navy's current removal action activity. The sunken areas are less than 10 feet square, and the concrete is badly cracked in those areas. The condition of the soil under the sunken areas is unknown. The sunken areas may be repaired by the Navy prior to transferring the building to NASA.

The concrete perimeter walls also appear to be in good condition. No concrete decay was noted during the site visit. The new doors in the hangar wall were saw cut through the concrete. The saw cut portion may need to be replaced for historical reasons.

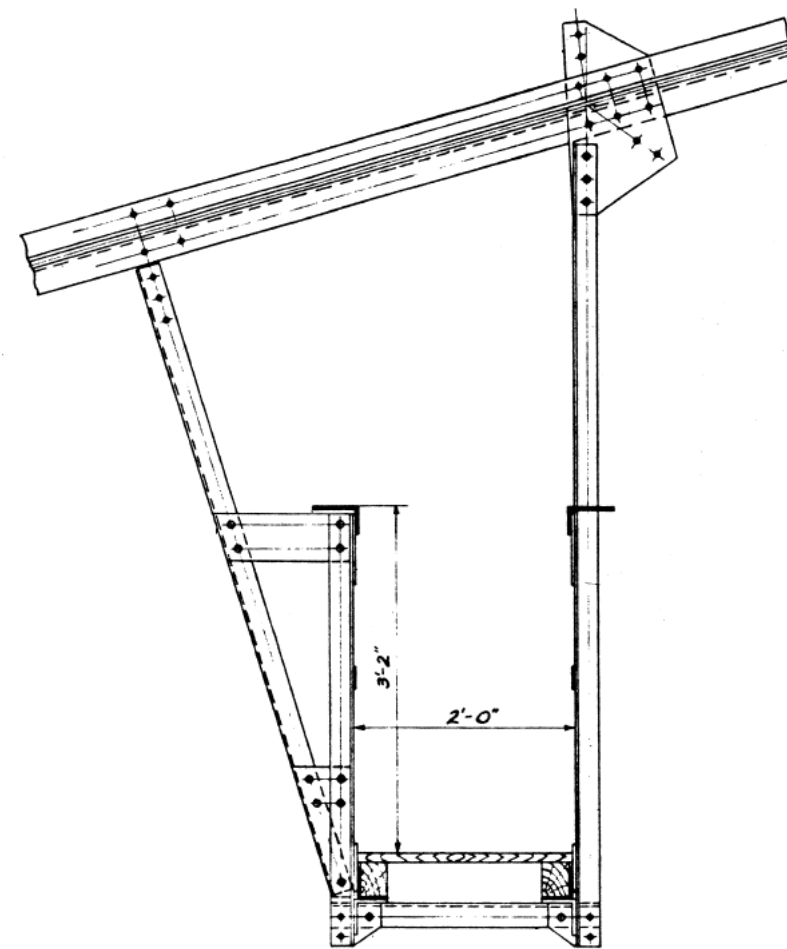

Figure 3-24: Typical Catwalk Section and Picture



The Page & Turnbull report dated August 2001 notes that the northern portion of the hangar slab contains lead dust. The extent of the contamination is not known. All residual dust will be collected and removed as part of the Navy's removal action. It is unknown if the lead dust contamination extends downward into the slab itself or is only a surface contaminant.

3.G Significant Repairs to Date

A previous report (Exeltech, 2008) noted that several longitudinal bracing members at an entrance in the eastern wall had been removed, possibly compromising the structural integrity of the hangar. The bracing has since been replaced by the Navy.

The original hangar slab was repaired in 1974. The middle 2/3 of the slab was replaced with a new 8 inch thick concrete slab (reference drawing M4-0001-C2).

3.H Miscellaneous Items

3.H.1 Grating

There is grating covering trenches around the hangar doors to catch runoff from the door structures. The grating is cast iron and is likely a custom size. Many of the grating sections appear to be in good condition, but some of the sections have fractured bars. There also appear to be some sections of the grating that have been replaced since the original construction with a different grating pattern than the original construction (reference drawing M4-0001-S60).

3.H.2 Cranes

There were originally several sets of cranes at different elevations along the hangar walls and at the mezzanine levels. The Navy is removing the crane rails as part of their removal action. (reference drawings M4-0001-S48, M4-0001-S49, M4-0001-S54). See section 2.B.4 for additional information.



Figure 3-25: Crane Beam End Connection



Figure 3-26: Typical Pipe Support at Hangar Wall

3.H.3 Mezzanine

Hangar One has a mezzanine level at the center of the “A” frames. The mezzanine floor is a flat steel plate. The mezzanine floor is, in places, corroded, but it is only a surface corrosion and does not appear to affect the structural capacity of the mezzanine. The coating being applied as part of the Navy removal action is designed to be applied over light rust. If any heavy rust is encountered, it should be removed prior to applying the coating. The mezzanine floor is integral to the structural stability of the hangar and cannot be removed. All of the interior rooms at the mezzanine level have been removed as part of the Navy’s removal action, but their removal did not affect the structures integrity. See section 2.B.2 for additional information.

3.H.4 Exterior Repair Pits

There are several exterior vaults (repair pits) at the clamshell door rails. The steel beams supporting the vault covers are corroded and will need to be replaced to support vehicle traffic (see figure 3-28 for vault location).

3.H.5 Pipe Supports

Pipes in Hangar One were supported from pipe hangers hung from the steel framing. The utilities and pipe supports are being removed as part of the Navy’s removal action. The original pipe supports did not appear to have sufficient lateral bracing for seismic resistance.

3.H.6 Railroad Tracks

There are railroad tracks down the center of the hangar as well as along the sides of the hangar and around the ends of the hangar doors. The railroad tracks at the hangar doors are surrounded by a contaminated material which will be removed as part of the Navy’s removal action. The railroad tracks at the center of the hangar are surrounded by an asphalt material which will be left in place.



Figure 3-25: Interior Area of Cell Room at Mezzanine

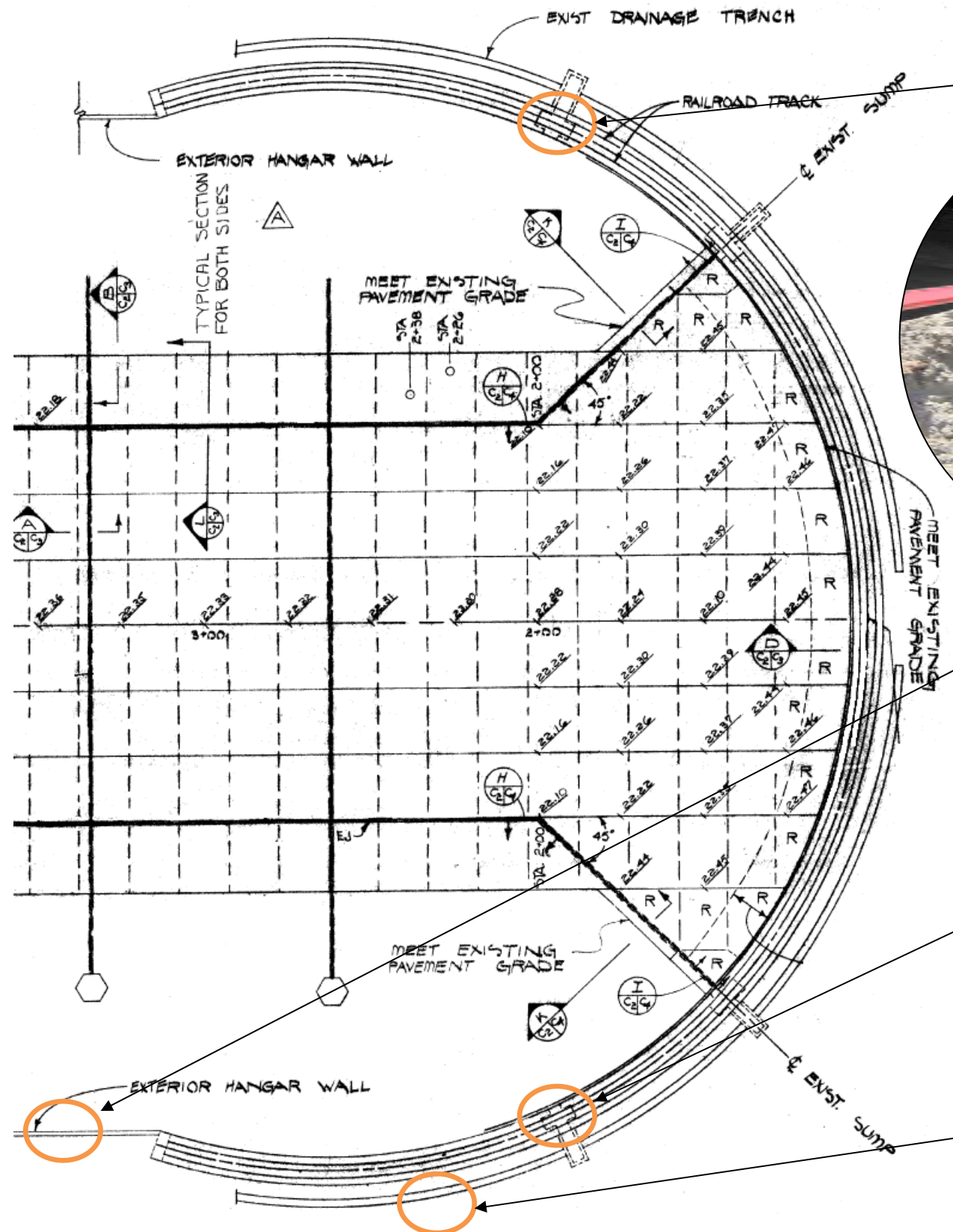

Figure 3-26: Plan View of Hangar End



Figure 3-27: Saw Cut Concrete Wall at New Opening in Hangar



Figure 3-29: Railroad Tracks



Figure 3-28: Repair Pit at Hangar Exterior Showing Corrosion



Figure 3-30: Typical Original Grating

4.0 Structural Analysis

4.A Summary

Exeltech Consulting, Inc. has completed this structural analysis and rehabilitation report to assist CH2M Hill with the Condition Assessment and Rehabilitation Plan (CARP) for the Hangar One structure at Moffett Field, California. The objective of this report is to evaluate the existing structural system for gravity, seismic and wind loads and provide strengthening options for basic re-skinning, re-skinning and use as storage, and re-skinning with historic and high-occupancy considerations to be incorporated in CARP.

Hangar One was designed in 1930 and constructed in 1932. It is one of the major historic contributing properties of the Shenandoah Plaza National Historic District and has come to symbolize Moffett Field.

Based on the review of the as-built documents, it is apparent that Hangar One was designed with very high standards of engineering for its time. However, the knowledge of earthquake loads and liquefaction impact on the building structure was very limited during that period. Since then, the codes and standards have substantially evolved due to knowledge gained based on studying the performance of structures in earthquake, wind, and liquefaction events. The Hangar designer considered a uniform fraction of total dead load as earthquake load and used uniform wind pressure on the structure. There is no apparent indication of the liquefaction consideration on the as-built drawings.

The CH2M Hill team reviewed the existing reports on Hangar One and visited the site to observe the condition of the structure. Based on our observation, almost all primary structural members are in sound condition and did not show any sign of distress or any evidence of damage from previous seismic or wind events.

The evaluation of the building was performed based on California Building Code (CBC) California Historic Building Code (CHBC) and the retrofit design was done per Seismic Rehabilitation of Existing Buildings (ASCE 41-06) guidelines. The results of our analysis indicate that the superstructure of the building has a complete load path. However, the analysis indicate that a number of Arch members and some of the single angle braces seem to be overstressed for Basic Safety Objective level of performance required for the Hangar. The overstressed members are identified in the RISA 3-D graphic model in Section 4G.

4.B Introduction

CH2M Hill requested that Exeltech Consulting, Inc. assist with the structural analysis and provide the structural analysis for inclusion in Condition Assessment and Rehabilitation Plan (CARP) of Hangar One at former Naval Air Station Moffett Field in Santa Clara County, California. The objective is to evaluate the existing structural system for gravity, seismic and wind loads strengthening options for the following scenarios: basic re-skinning; re-skinning and use as storage; re-skinning and use as a hangar; and re-skinning with historic and high occupancy considerations to be incorporated in CARP.

4.B.1 Scope of Work

The scope of work for this evaluation is as follows:

- Review as-built documents and reports
- Perform a site visit and evaluate the existing condition of the facility

- Perform analysis of the hangar for gravity, wind, and seismic loads for the desired performance levels
- Identify deficient elements and develop retrofit concepts for the occupancy categories identified in section 6.A, Rehabilitation and Re-use Options.
- Develop quantity estimates for the proposed retrofit options
- Prepare a report of the condition assessment , rehabilitation plan and option analysis

4.B.2 Exclusions from the Study

- Any non-structural elements in the hangar

4.B.3 Applicable Codes and Standards

- California Building Code (CBC), 2010
- California Historic Building Code (CHBC) 2010
- American Society of Civil Engineers, ASCE 41-06
- American Society of Civil Engineers, ASCE 7-05
- American Institute of Steel Construction AISC Manual 13th Edition
- NISTIR 6772 Standards of Seismic Safety for Existing Federally Owned and Leased Buildings
- National Historic Record, California
- Ames Research Center Procedural Requirement 8829 -1
- American Society of Civil Engineers, ASCE 31-03

4.B.4 Material Properties and Assumptions

The existing as-built documents received from NASA do not have the required material properties for the structural steel members. Non-destructive testing has not been performed to ascertain any of the material properties. Therefore, the properties used for the analysis are based on ASCE 41-06 and AISC for the period of construction. The member sizes have been assumed per as-built drawings. Only spot checks were done during the site visit to validate member sizes.

Concrete strength assumed is 3000 psi.

Structural Steel Materials As mentioned in material properties, the steel members are assumed to be of A7/A9 Grade 30 steel (yield strength 30 ksi), which was in common use at the time of construction. Rivets are assumed to be of steel with 46 ksi tensile and 25 ksi yield strength.

An article about a similar hangar (Higley, 1929) notes that the arch chords used in the hangar are Silicon steel with 46 ksi strength. However without testing, it was decided to use the A7 for this evaluation. The Seismic site classification used is Site Class "D" per the geotechnical report, assuming the ground improvements recommended by CH2M HILL (September 2011) are performed. See Section 5.0. Testing of the possible silicon steel should be included as a Value Engineering (VE) option for the final design. It is possible that testing could reduce the number of overstressed members and reduce the cost of retrofits.

4.B.5 Bases of Evaluations

1. As-built drawings – 1931
2. Hangar One Re-use Guidelines Report by Page & Turnbull – August 24, 2001
3. The Rutherford & Chekene report – December 1984

4. Geotechnical Report for Conditions Assessment and Rehabilitation Plan (CARP) by CH2M HILL – Section 5.0
5. Photos taken during the Site Visit – 2011
6. Historical Pictures of the Hangar from the Museum in Moffett Field
7. Structural Analysis and Gravity, Wind and Seismic Vulnerability Study by Exeltech Consulting, Inc – July 2008
8. Condition Assessment Report – Structural by CH2M Hill– 2011
9. <http://www.historicproperties.arc.nasa.gov>

4.C Structural System Description- See Section 3.0, Structural Condition Assessment.



4.D – Geotechnical Report- See Section 5.0

4.E Evaluation and Analysis

4.E.1 Evaluation Methodology

The structural evaluation of the Hangar One for gravity, wind and seismic vulnerability is done in accordance with California Building Code (CBC) 2010. CBC per section 3409 references California Historic Building Code (CHBC) 2010 Title 24, Part 8 and also per section 3420 refers to ASCE 41-06 for the retrofit of the existing buildings. CHBC refers to California Building Code (CBC) for wind analysis. Therefore based on the code requirements above the evaluation is based on ASCE 7-05 for wind and ASCE 41-6 for seismic.

4.E.1.1 Seismic Analysis and Loading

The seismic evaluation was performed according to criteria found in ASCE 41-06, entitled “Seismic Rehabilitation of Existing Buildings”.

According to the ASCE 41-06 Methodology of Rehabilitation, objectives are first selected for the evaluation and retrofit design. These objectives are statements of the desired Building Performance Level, or the extent of damage expected when the building is subjected to earthquake demands of a specified severity. Possible Building Performance Levels are, in the order of most damage to least damage expected, Collapse Prevention, Life Safety, Immediate Occupancy, and Operational Performance. As could be surmised, the costs and difficulties of rehabilitation efforts increase as the amount of expected damage increases. For the Hangar building, it is desired to meet the life safety (LS) level.

The specified severity, or hazard level, of the design earthquakes is specific for the building site, and is typically stated in terms of the probability that the severity of the design earthquake shaking will be exceeded in a given period of time, or for a given return period. The lower the chance of exceedence (the longer the return period) for a design earthquake at a given site, the higher the energy output of the earthquake. For example, earthquake shaking with a 2 percent chance of being exceeded in 50 years would have a higher energy level than earthquake shaking with a 10 percent chance of being exceeded in 50 years, at the same site. However, the earthquake with a 2 percent chance of being exceeded in 50 years is statistically less likely to occur than the earthquake with a 10 percent chance of being exceeded in 50 years. The design earthquake for this evaluation has 10% chance of being exceeded in 50 years.

The rehabilitation objective for this evaluation of the hangar is Basic Safety Objective as described in table below:

Rehabilitation Objective	Building Performance Level	Earthquake Hazard Level	Earthquake Return Period
1	Collapse Prevention (CP)	2% in 50 years	2,475 years
2	Life Safety (LS)	10% in 50 years	475 years

Table 4-1 – Rehabilitation Objectives

The performance expectations described in ASCE 41-06 for the Collapse Prevention performance level assume that, after an earthquake of a specified severity, the building structure may be on the verge of total or partial collapse. Substantial damage to the structure has occurred, potentially including significant degradation in the stiffness and strength of the lateral-force resisting system, large permanent lateral deformation of the structure and, to a limited extent, degradation of the vertical-load carrying capacity. All significant components of the gravity-load-resisting system should, however, continue to carry their gravity load demands. Significant risk of injury due to falling hazards from structural debris may exist. The structure may not be technically practical to repair and may not be safe for re-occupancy.

The performance expectations described in ASCE 41-06 for the Life Safety performance level assumes that, after the earthquake of a specified severity, some structural elements and components are severely damaged but without falling debris hazards, either within or outside the building. Some permanent building lateral drift may be present. Injuries may occur during the earthquake, but it is expected that the overall risk of life-threatening injury as a result of structural damage is low. It should be possible to repair the structure, but for economical reasons, it may not be practical. Repairs should be made to any damage prior to re-occupancy of the building.

The Pseudo lateral force was developed based on the period and the response spectra per ASCE 41- 06 for different sections of the building for both longitudinal and transverse directions based on the selected performance level for site class “D”, (reference Geotechnical Report) The periods for building sections are obtained from the dynamic analysis of the 3-D model of the hangar using the RISA – 3D computer program).

4.E.1.2 Building Period (Seconds) and Seismic Modeling:

Middle Section		End Section	
Longitudinal Direction	Transverse Direction	Longitudinal Direction	Transverse Direction
.83	1.334	.837	1.175

Table 4-2 – Building Periods in Both Directions

The response spectra used is per the geotechnical report. The base shear was then distributed along the height of the building for all arches. The seismic load combinations were developed per ASCE 41-06 and were reduced to account for the increase in structural capacities of the existing structural elements. This reduction is similar to the current codes modification factor of the base shear for the lateral system (Ductility factor “R”). The reduction is the same for all elements of the lateral resisting system in the current codes. However, per ASCE, the increase in structural capacities (reduction of the base shear) is dependent on the assumed mode of failure of the individual elements and on the assumed level of inelastic deformation that the element can support. When determining increase in their capacities, structural elements are considered to be either deformation controlled (ductile) elements, which will deform and allow inelastic displacement, or force controlled elements, which will fail with little if any inelastic displacement.

According to the ASCE methodology, deformation controlled elements, typically controlled by bending or axial tension such as bracing elements of the hangar, are assigned “m” factors that modify (typically increase) expected strength of the member. The “m” value of 5 is used for braces for the Life Safety (LS) and a value of 7 is used for Collapse Prevention (CP). The “m” value of 3 was used for piles for both performance levels. Therefore, the applied loads were adjusted to take these “m” factors into account.

The applied seismic force for the force controlled elements (typically controlled by shear or axial compression) such as columns, is reduced by 50% to account for the force delivery reduction factor “J” for both cases of LS and CP.

The load cases take the “m” factors into account in addition to considering the resisting system for a given direction into account. Since the load distribution changes at the point of A frame connection to the arches, members above A frame were analyzed with the arches and the bracing members between A frame were analyzed separately.

ASCE 41-06 also modifies the capacity of the structural elements with a knowledge (k) factor. The knowledge factor is an attempt to quantify the quality of knowledge that is available about the means, methods, and materials used during the design and construction of the building, and also the amount of available information concerning the current condition of the building. Typical knowledge factors have values of 0.75 or 1.0. ASCE 41-06 recommends that an extensive site survey and in-place testing of existing materials be performed to use a factor of 1.0 for an evaluation. Although a limited survey was undertaken and no tests were performed, a knowledge factor of .85 has been assumed for all elements analyzed during this evaluation, based on our observation that the exposed structure was in sound condition.

4.E.1.2 Wind Analysis And Loading

CHBC 2010 refers to CBC 95 for lateral loads. However, wind analysis was performed according to ASCE 7-05 as required by NASA. The 3-second gust basic wind speed of 85 miles per hour with exposure “C” and applicable importance factors were used for calculating the wind loads. An importance factor of 1.15 was used for the high occupancy option.

The load combinations prescribed in ASCE 7-05 were used. Wind loading and seismic loading was reduced to 75% of the applied loads allowed by CHBC 2010 for Historic Buildings in determining the adequacy of the structure. This is reflected in the load combinations used to analyze the structure.

4.E.2 Structural Analysis and Computer Modeling

For the selected objective, per ASCE 41, a linear elastic procedure was used for the analysis in accordance with ASCE 41-06, which states that for regular structures, linear elastic procedure shall be permitted (section C2.4.1.1). For this procedure a 3-D model of the hangar was developed using a commercially available structural analysis software, RISA 3D.

The building, with two expansion joints and two symmetrical end sections (the north and south sections), required two separate computer models – one for the end sections (Gable Arch to Arch 4 and Arch 11 to Gable Arch) and another model for the middle section (Arch 5 through Arch 10).

A separate model for the door rib was also developed to check the loading and evaluate the door structure. The door ribs transfer the lateral load to the end section through the connecting pin at top of the door on Arch 1 and 14. The oblique arches loading included the Gable Arch on both ends since they are not a contributing part of the lateral resisting system so they are not included in the model. For the model geometry and the structural member sizes, the as-built documents were used. Since there are a number of built-up sections in addition to the standard sections used in the hangar, custom section sets were created in the RISA data base. The new sections added in the data base have the same properties as the combined sections shown on the drawings. The model included all of the structural elements including the lateral resisting elements, the arches, all the trusses between the arches , A-frames and the trusses connecting the A frames.

The pile foundations were modeled as springs. The spring constants were developed in the Geotechnical Report (see Section 5.0).

4.E.2.1 Acceptance Criteria

The performance of the building was evaluated based on the acceptance criteria of ASCE 41- 06. The load combinations were adjusted for the failure mode of the elements and also the applicable reduction (.75)

allowed per CHBC to get the Demand Capacity Ratio (DCR) values (unity checks) from running the model on RISA 3-D. RISA was used to evaluate the seismic performance of the building. The load combinations in RISA were adjusted to simplify the analysis and computation of the DCR values. The DCR remains unchanged by reducing the demand in proportion to the increase in capacity allowed per ASCE. Therefore this allows the calculation of DCR directly by RISA program and the DCRs can be displayed in graphic form. In the RISA graphic output, the members with a unity check representing the Demand Capacity Ratio (DCR) greater than one are identified in red in the graphic output of the RISA analysis. A selected number of connections were analyzed and the DCR values determined (see Table 4-3 in Section 4.F).

4.F Analysis of Results

The above analysis was performed only for the Life Safety (LS) objective for the Earthquake Hazard Level of 10% in 50 years. The Collapse Prevention (CP) for 2% in 50 years in all cases is automatically satisfied by the structure meeting the LS criteria. For the period of the structure ranging from 0.84 to 1.3 seconds, the Spectral Acceleration (SA) is nearly equal for LS and CP resulting in the same base shear and same lateral force for the structure. The increase in “m” values for the CP case per ASCE 41-06 table of Acceptability Criteria for Linear Procedures further reduces the DCR Value.

Table 4-3 below is a summary of the DCRs based on the 3-D analysis and also based on the new skin of the hangar. The table lists the maximum DCR determined in the analysis for the member groups listed. The actual members with a DCR higher than one, indicating a deficiency, are noted on the RISA graphic outputs included in Section 4.H.

The analysis was performed for all load cases - gravity, wind, and seismic. The results were obtained using the envelope solution, which includes all load combinations and reports the highest unity value from all load combinations for every member.

Member Group Location	DCR From 3-D Analysis (max)
Main Arches	1.3
Truss Members above A Frames	1.9
Truss Members between A frames	1.7
Pile Foundation	0.88
Representative Connection	<1.0

Table 4-3 – Summary of the DCRs of the Original Structure for Wind, Gravity and Seismic Loads for assumed Site Class D

The analysis was revised to incorporate the actual siding and roofing loads based on new materials. The loading has been reduced about 20% from the original siding and roofing. This reduction not only reduced the gravity loads but also reduced the seismic load in proportion to the skin load by about 10%.

Based on our analysis, a number of single angle braces and some Arch chords have DCRs greater than one which indicates an over-stressed condition and require strengthening. It is important to note that a lot of the deficient members are the single angles. The small angle and the longer length members have a very high slenderness ratio which reduces the strength of the member resulting in an increase of the DCR values. In our analysis, we have not limited the slenderness ratios recommended by AISC. We have used the actual slenderness ratios to calculate the capacities of the members. The single angles may have been originally considered as tension only members.

In our evaluation and the current analysis we have considered the smaller angles above the A-Frames (secondary bracing elements) as tension only members. The single angle braces between the A-frames are primary lateral force resisting elements and to be consistent with FEMA 274 (NEHRP commentary on the guidelines for the Seismic rehabilitation of buildings) Section C10.5.4.2 B they are considered as tension/compression elements. A number of these primary single angles are among the overstressed members.

4.G Conclusion

In the original design, many of the bracing members were considered as tension only. Per FEMA 274 (Commentary to FEMA 273 which was the bases for the development of FEMA 356 and ASCE 41) and current seismic design practice, tension only braces are not allowed for building taller than 2 stories. In our 3-D analysis we have considered members as tension only in the single angles above the A-frames. Single angle members at the A-frame level have been considered as tension/ compression members. It is important to note that most of the deficiencies were caused by seismic loads and very few were controlled by wind. The RISA 3-D graphics in section 4.H show the overstressed members in red. There are separate graphs for seismic alone and for wind alone for the two categories.

The structural analysis and evaluation of the building is based on soil site class D forces and no appreciable differential settlement due to liquefaction. The geotechnical portion of the report, however, identifies the possibility of soil liquefaction and therefore requires soil remediation to meet the site class D forces used in the linear elastic procedure. Any soil remediation design and future geotechnical investigations need to take into account the contaminated groundwater at the site and must be approved by NASA to ensure that the contamination is not spread or migrated into areas that are currently not contaminated. The soil remediation and future geotechnical investigations must also not interfere with the Navy’s remedial measures to clean up the ground water contamination and must take into account the constraints in the USEPA MEW Study Area Record of Decision Amendment for the Vapor Intrusion Pathway. The building may be alternately evaluated with an additional non-linear structural analysis based on additional site specific geotechnical analysis, which may result in both reduced expected settlements and amplified accelerations. The non-linear analysis method may be included as a value engineering (VE) option for the final design which may reduce the amount of steel needing retrofitting as well as reducing the amount of required soil remediation. The approach used in this report is intended to meet current building codes and standards; however it does not include all possible analysis methods. Based on the information available at the time of this study, the approach used in the geotechnical analysis portion of this report is conservative with regards to the settlement potential in order to capture the maximum probable required soil and steel mitigation.

In our analysis, we have considered site class D assuming a mitigated soil condition. The geotechnical report indicates that the soil under the hangar is liquefiable and, in the event of the design earthquake, it is likely that differential settlement could occur. The differential settlement impact cannot be assessed here as no geotechnical analysis is done to quantify that. In addition, the liquefaction may cause added load on the piling that may cause foundation over-stress. The excessive settlement and foundation failure may ultimately cause partial or full collapse of the building. **The model was analyzed with an assumed differential settlement number (by CH2M Hill) in conjunction with the site class D forces. The intent was to just get a feel of how it impacts the structure. The retrofit requirements shown in this report do not consider differential settlement. The true impact requires further geotechnical study as well as non-linear analysis to see the building performance.**

In addition to the 3-D RISA model, we have used the original designer's forces and developed spreadsheets to calculate DCRs. It is interesting to note that most of the members meet the DCR of one. Their seismic load assumed was 1/6 of the dead load and was uniformly distributed over the height of the building. This is rather close to the base shear for braces. However, for the Arches, their number is lower. Also, we have the load distribution that increases with the height of the mass. The applied forces for seismic are, therefore, higher than the original design values.

The hangar has been designed well considering the time when it was built. There was very little code knowledge of the seismic loads at the time. The hangar structure has a complete and continuous load path, including connections from every portion of the structure to the ground, and there is no evidence of distress in the structure. Additionally, the anticipated dead and live loads will not exceed those historically present.

4.H RISA 3-D Graphic Models

4.H.1 Computer Models

1. Hangar 3-D model for the End Section
2. Hangar 3-D model for the End Section - Arches
3. Hangar 3-D model for the Middles Section
4. Hangar 3-D model for the Middle Section - Arches
5. Hangar 3-D model for the Door

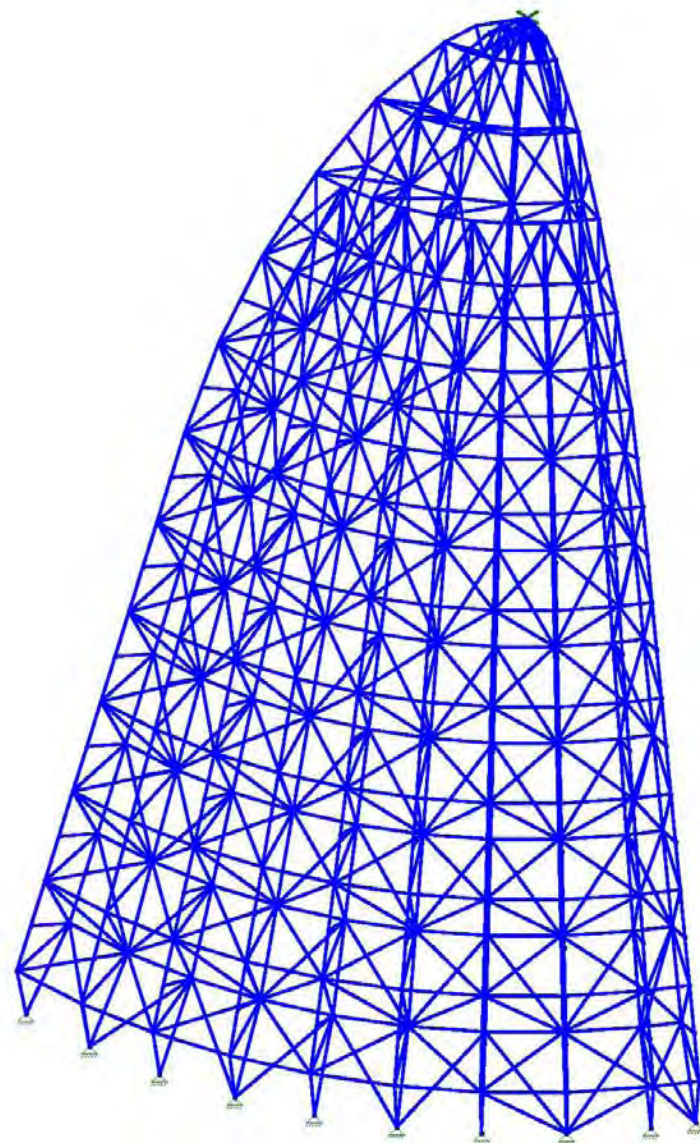

Results for LC 3.

ExelTech
AJC
1123

Hangar 1 - Door Model
3-D Door Model Member Sections

SK - 2
Sept 16, 2011 at 3:33 AM
Hangar Multi Door Rib Load MMA 08252011.r3d

5.0 Geotechnical Report

5.A Introduction

Hangar One is located to the west of the airfield at Ames Research Center at Moffett Field, California, as shown in Figure 5-1. The Navy is currently performing a removal action on the building to remove known contaminants. Subsequent to the removal action, NASA plans to rehabilitate the building, which includes replacement of its skin and any required modifications for the various future use alternatives.

CH2M HILL is conducting a Conditions Assessment and Rehabilitation Plan (CARP) to assess the current building conditions and to evaluate various rehabilitation and future use alternatives of the building. This report summarizes the results of our geotechnical study conducted in support of the CARP.

5.A.1 Objectives

As part of the CARP, CH2M HILL and Exeltech performed a structural analysis of Hangar One. The primary objectives of the analysis were:

- To assess the structural capacities of the existing structure and its foundation system
- To evaluate any modifications and/or reinforcements that may be required to support the various rehabilitation alternatives

The analysis consisted of static and dynamic structural response evaluations. The responses under the existing and anticipated future loads were evaluated, including the seismic loads generated from the occurrences of major earthquakes in the region. The effects of the pile foundation stiffness on the structural responses were also assessed.

5.A.2 Scope of Work

To support the above structural analysis, CH2M HILL performed a geotechnical study that included:

- Review of existing data and information
- Characterization of subsurface soil and groundwater conditions at the building site
- Review of existing seismic design parameters and development of the updated seismic design parameters based on the latest seismic design standards or codes
- Evaluation of seismic-induced geologic hazards
- Development of geotechnical recommendations, including ground improvement methods for liquefaction and pile foundation's capacity and stiffness for structural analysis

5.A.3 Limitations

This geotechnical report has been prepared in accordance with generally acceptable engineering practices. It is intended for the exclusive use of NASA for the proposed rehabilitation project. Information contained in this report is limited, based on data obtained from limited exploration logs that show subsurface conditions only at the specific locations and times indicated, and only to the depths penetrated.

Subsurface conditions and water levels at other locations or depths may differ significantly from conditions indicated at the exploration locations. The passage of time may result in change in the conditions at the locations. If, during construction, subsurface conditions are found to vary from those described in this report, the geotechnical recommendations presented herein are not warranted valid.

This report contains both factual and interpretive information. Factual information is defined as objective data based on direct observations, such as boring or CPT logs and laboratory test results. Interpretive information or geotechnical engineering interpretation is based on engineering judgment or extrapolation from factual information. No warranties, explicit or implied, are provided.



List of Figures

- 5-1 Hangar One Building Site Location
- 5-2 Approximate Locations of CPT Soundings and Groundwater Wells for the Current Study
- 5-3 5%-damped Acceleration Response Spectrum (ASCE-7, 2010)
- 5-4 5%-damped Acceleration Response Spectrum (USGS National Seismic Hazard Mapping Program, 2008 Data)
- 5-5 5%-damped Acceleration Response Spectrum (ASCE-41-06)
- 5-6 Schematic Drawings of Pile Groups A-1 and A-2
- 5-7 Load-Displacement Relationship for Pile Group A-1 (Axial and Lateral Axis)
- 5-8 Load-Displacement Relationship for Pile Group A-1 (Moment)
- 5-9 Load-Displacement Relationship for Pile Group A-2 (Axial and Lateral Axis)
- 5-10 Load-Displacement Relationship for Pile Group A-2 (Moment)

List of Tables

- 5-1 Significant Seismic Sources in the Vicinity of Building Site
- 5-2 Calculated PGA Values for Various Standards
- 5-3 Design Soil Profile and Parameters
- 5-4 Axial and Lateral Capacities of a Single Pile
- 5-5 Reduction Factors to Account for Group Effects

Attachments

- A Available CPT and Well Logs
- B Results of Liquefaction Analysis

Acronyms and Abbreviations

ARS	Acceleration Response Spectrum
AP	Alquist-Priolo
ASCE	American Society of Civil Engineers
bgs	below ground surface
CARP	Conditions Assessment and Rehabilitation Plan
CBC	California Building Code
CPT	Cone Penetration Test
CGS	California Geological Survey
FS	Factors of Safety
PGA	peak ground acceleration
SPT	Standard Penetration Test
USGS	United States Geological Survey

Figure 5.1 Hangar One Building Site Location

5.B Subsurface Conditions

5.B.1 Geologic Setting

Hangar One is located within the Santa Clara Valley, at the southern end of the San Francisco Bay within the Coast Ranges Geomorphic Province. The northwesterly trending mountain ranges and valleys, which generally run sub-parallel to the San Andreas Fault system, dominate the Coast Ranges Geomorphic Province. A depression, containing the San Francisco Bay, separates the northern and southern ranges of the province [California Geological Survey (CGS), 2002].

The San Francisco Bay lies within a structural trough bounded by the Coast Range to the west and the Diablo Range to the east. The Santa Clara Valley fills the southern end of this trough, and it forms an approximately 240-square mile coastal watershed that drains parts of Santa Clara and San Mateo Counties (USGS, 2004).

The major geologic units within the Santa Clara Valley generally include the following (after Lajoie and Helley, 1975, and Helley and Lajoie, 1979):

- Holocene estuarine deposits (or Bay Mud) and Holocene alluvial deposits: these deposits consist of clay, silty clay, silt, sand, and gravel
- Late Pleistocene alluvium: this deposit is similar to Holocene alluvial deposits, but slightly consolidated
- Pliocene and Early Pleistocene alluvium deposits (Santa Clara Formation): these deposits are tectonically deformed, moderately indurated, and consist of conglomerate, sandstone and siltstone, with minor lacustrine mudstone
- Mesozoic Franciscan Formation: this formation consists of well-indurated sandstone, chert, and altered volcanic rocks

Published shallow groundwater maps, showing the historic highest known groundwater levels, indicate a groundwater depth of less than 5 feet below ground surface (bgs) in the area (CGS, 2006).

The valley consists of gently sloping topography, formed by coalescing alluvial fans, with levees along the principal stream channels that drain generally northward to San Francisco Bay.

5.B.2 Previous Subsurface Investigations

Various groundwater studies (including well installation and monitoring) and geotechnical investigations have been completed near and at the building site. For the current study, CH2M HILL reviewed the following available reports and soil logs:

- *Structural Analysis, Gravity, Seismic & Wind Vulnerability Study, NASA Moffett Field, Moffett, California.* Report prepared by Exeltech and dated July 24, 2008
- *Former Building 88 Investigation Report, Former Naval Air Station Moffett Field, Moffett Field, California.* Draft report prepared by Tetra Tech, Inc. and dated July 21, 2006
- *West-Side Aquifers Treatment System Optimization Completion Report, Former Naval Air Station Moffett Field, Moffett Field, California.* Report prepared by Tetra Tech, Inc. and dated May 17, 2005
- *Limited Geotechnical Recommendations, Hangar 1, Moffett Field, Mountain View, California.* A letter memorandum prepared by Ninyo and Moore and dated April 24, 2008

The majority of the soil investigations was conducted using Cone Penetration Test (CPT) soundings that were pushed along the western and northern sides of the building. Several groundwater monitoring wells were also installed in these areas, as part of the groundwater contamination studies performed for the adjacent facilities. Figure 5-2 shows the approximate locations of some of these CPT soundings and wells, and Attachment A presents the logs.

5.B.3 Subsurface Conditions

No additional soil investigation was conducted for this study. The information presented on the available CPT and well logs indicates that the building site is underlain by mostly clayey silt and silt, and to a lesser extent, by silty clay. The available logs also show numerous layers or pockets of silty sand, sand, and gravelly sand, extending to at least 60 feet bgs. These sandy and gravelly soil layers or pockets tend to be thicker and more abundant toward the southern end of the building. The Standard Penetration Test (SPT) N-values (i.e., sampler penetration rate in blows per foot) estimated from the CPT data generally range from low to medium, indicating loose to medium dense sandy soils.

Based on the limited field data, groundwater was encountered within 20 feet bgs during the field investigations. However, as mentioned previously, published shallow groundwater maps indicate a shallow groundwater depth of less than 5 feet bgs in the project area (CGS, 2006). Groundwater variation can be expected due to seasonal variation, influenced from the tidal fluctuations in the Bay and human activities.

No subsurface information was made available to us at the time of this study for areas inside and along the eastern side of the building. We assume that similar subsurface conditions are present throughout the building site. Because the soil and groundwater conditions were interpreted using limited data and only to the maximum depth explored, subsurface conditions between borings/soundings may differ significantly from those shown on the logs.

5.C.3 Design Parameters and Response Spectra

In 2008, Ninyo and Moore developed a 5%-damped design acceleration response spectrum (ARS) for the building, in accordance in the 2007 California Building Code (CBC) using the USGS mapped spectral acceleration parameters. The ARS was developed for a stiff soil site (Soil Class D), and it has a design PGA of 0.4 g.

Since the above Ninyo and Moore study, new editions of standards and codes were issued, including the following:

- The 2010 edition of ASCE-7: updates include risk-adjusted hazard and maximum direction design ground motion
- In 2008, USGS had further updated their seismic data for the National Seismic Hazard Mapping Program based on the latest understanding of seismic sources and development of new ground motion attenuation models
- The 2010 edition of CBC: updates include more-recent earthquake ground motion predictions or parameters from USGS. Note that the seismic parameters used in the 2010 CBC are based on the older (2002) USGS data.

CH2M HILL reviewed these new standards, and estimated the design seismic parameters using their seismic requirements. Figures 5-3 and 5-4 show the 5%-damped ARS curves developed in accordance with the 2010 ASCE-7 and 2008 USGS seismic data. For the 2008 USGS data, ground motions associated with the following return periods were developed: 72 years, 224 years, 475 years and 2,475 years (corresponding to 50%, 20%, 10% and 2% probabilities of being exceeded in 50 years, respectively). Because the building is located at about 14.5 km from the San Andreas Fault, the near-fault effects on long-period motions (periods greater than 0.5 seconds) were included in the figures for considerations.

We understand that the current study also considers the ASCE-41 (2006) as the basis for the structural analysis. This standard considers two level design earthquakes (BSE-1 and BSE-2 earthquakes) for structural performance evaluation during earthquakes. Figure 5-5 presents the calculated 5%-damped BSE-1 and BSE-2ARS curves developed using the guidelines of ASCE-41 (2006).

Table 5-2 below compares the PGA values calculated using the various standards discussed above.

TABLE 5-2
Calculated PGA Values for Various Standards

Standards	Peak Ground Acceleration, g						
	Design	72-years	224-years	475-years	2,475-year	BSE-1	BSE-2
ASCE-7 (2010)	0.40	-	-	-	-	-	-
2008 USGS Data	-	0.24	0.37	0.47	0.73	-	-
ASCE-41 (2006)	-	-	-	-	-	0.44	0.60

Note that the ARS curves and PGA values developed above are for a Seismic Site Class D (a stiff soil site), with an average shear-wave velocity in the upper 100 feet of the site soils of 275 m/sec (or 900 feet/sec). As discussed in Section 5D below, the cohesionless soil underlying the hangar site is susceptible to liquefaction under the design earthquakes. Per the building codes, a site with liquefiable soil should be classified as Seismic Site Class F for ground motion characterization. Furthermore, the codes

require that a site-specific response analysis be performed for Site Class F to evaluate the effects of liquefied soil on earthquake ground motion. However, if the liquefiable soil is mitigated, as recommended in Section 5D.4 below, the site can be classified as Seismic Site Class D; a Site Class for which the seismic design parameters presented herein have been developed for. Failure to mitigate soil liquefaction will result in different seismic design parameters than those presented in this section.

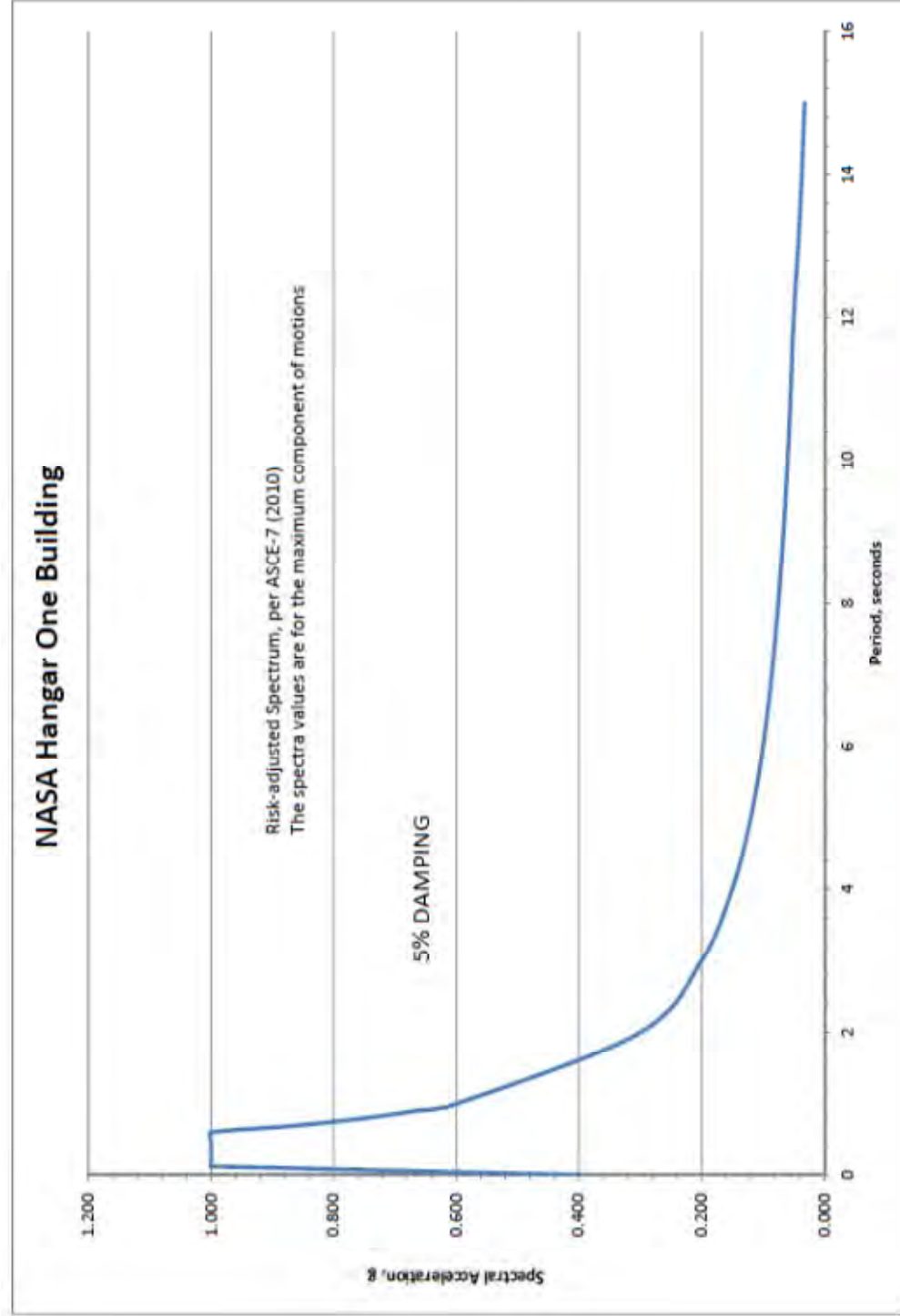

FIGURE 5-3
5%-damped Acceleration Response Spectrum (ASCE-7, 2010)

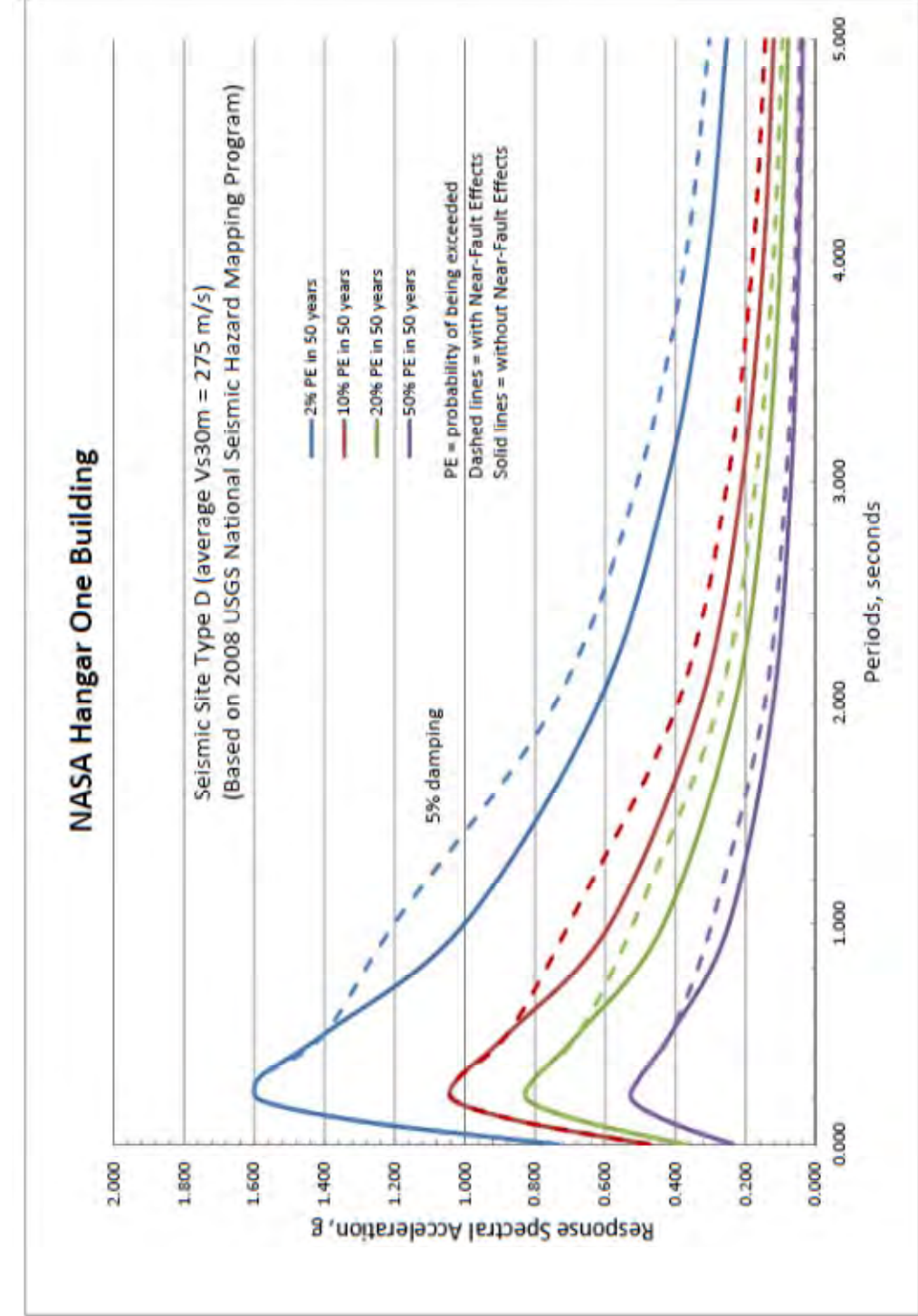

FIGURE 5-4
5%-damped Acceleration Response Spectrum (USGS National Seismic Hazard Mapping Program, 2008 Data)

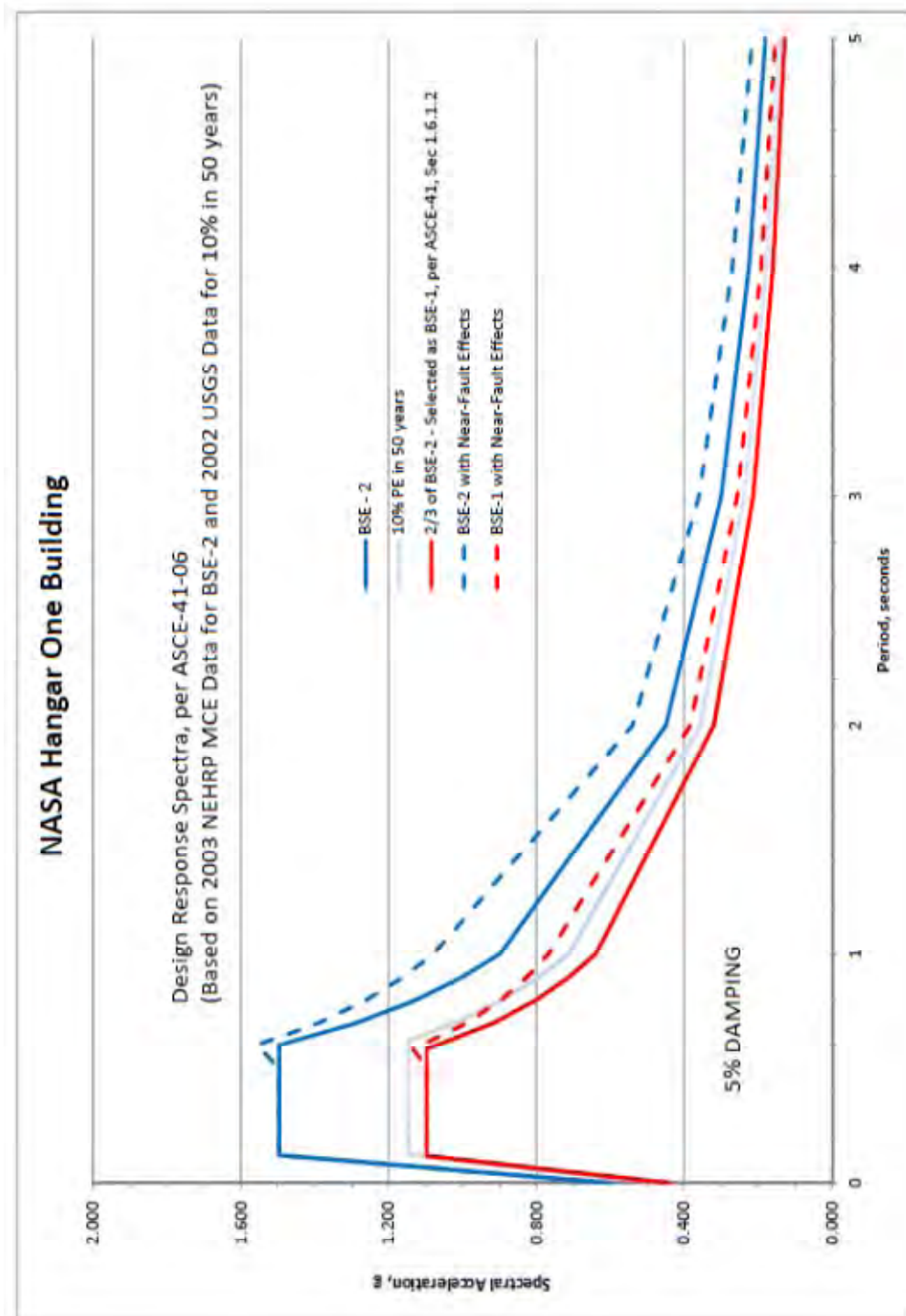

Figure 5-5
5%-damped Acceleration Response Spectrum (ASCE-41-06)

5.D Engineering Analysis

5.D.1 Seismic Geologic Hazard Evaluations

The seismic geologic hazards considered in this study include fault crossing and liquefaction. Section 5.C discusses the geologic hazards associated with earthquake ground shaking. Liquefaction is a process whereby strong ground shaking causes loose and saturated soil sediments to lose strength and to behave as a fluid. This process can cause excessive ground deformations and failures, resulting in damages to structures and facilities.

5. D.2 Fault Surface Rupture

According to the available maps of Earthquake Fault Zones published by the CGS (2006), the NASA Hangar One Building is not located within any State of California designated Alquist-Priolo (AP) Zone. Hence, the potential of having ground surface rupture or displacement at the building site associated with any known active faults is judged to be insignificant.

5.D.3 Liquefaction Potential

The computer program LiquefyPro (version 5.3c, CivilTech, 2006) was used to evaluate the liquefaction potential of the cohesionless soils (i.e., silty, sandy, and gravelly soils) underlying the building site. An earthquake magnitude of 7.9 and a PGA value of 0.6 g were used for the analysis, corresponding to the occurrence of a maximum earthquake on the nearby San Andreas Fault.

Factors of Safety (FS) against liquefaction were calculated at various depths and sounding locations based on the above earthquake parameters, CPT tip resistances, overburden stress and depth to groundwater. The analysis results indicate that the cohesionless soils underlying the building have medium to high potential to liquefy during the maximum earthquake. These liquefiable soils appear to be confined to thinner layers on the northern end of the building, and they become more wide spread toward the southern end of the building. Attachment B presents the results of liquefaction analysis.

It should be noted that the analysis was performed using the available information on CPT soundings that were pushed along the western sides of the building. We assume that similar subsurface conditions, and hence the liquefaction potential, are present for other areas of the building. Also, the analysis was based on limited data, and hence, the results should be considered preliminary.

The consequences of liquefaction are manifested in terms of dynamic compaction or settlement, temporary loss of bearing capacity, lateral spreading (soil movement), increased lateral soil pressure, and down-drag forces on foundation piles within zones of liquefaction. These liquefaction-induced hazards will adversely impact the building and foundation performances during a major earthquake in the region.

The impacts of liquefaction on the building pile foundation include:

- Excessive settlements of the soils surrounding the piles that would induce down-drag forces on the piles, leading to more pile settlement and possibly overstressing the piles
- When soil liquefies, its shear strength will reduce to the so-called “residual strength”, which is typically a small fraction of the strength prior to liquefaction. When this happens, the pile axial and lateral capacities will be compromised and may cause foundation failure
- Because of the inherent variability in soil conditions over the building area, the liquefaction-induced settlements would likely vary at the various pile foundation locations. This could lead to large differential settlement at adjacent foundations

- Given the flat topography at the building location, the potential of liquefaction-induced lateral spreading is judged to be insignificant. Therefore, the impacts to the pile foundations due to lateral spreading are likely to be minimal

5. D.4 Ground Improvement for Liquefaction

We recommend that the subsurface soils be improved to mitigate the liquefaction potential. Considering the soil conditions and potentially contaminated groundwater at the building site, we recommend the following in-situ ground improvement methods be considered:

- *Vibro Compaction.* This method densifies the ground using a vibratory probe, and it works well in granular soils. The process involves lowering the probe to the design depth of improvement and gradually raising the probe while generating vibratory energy that allows soil particles to move into a denser configuration. This process typically results in a depression at the ground surface that needs to be backfilled to final grade.
- *Jet Grouting.* This method stabilizes the ground by creating in-situ cemented soil columns called soilcrete. It is a bottom-up process, and involves drilling to the design depth and then injecting the slurry into the soil with a high velocity to create soilcrete column. Various grout materials can be used, including portland cement and fly ash.
- *Deep Soil Mixing.* This method involves in-situ mixing the soil with grout slurry (cement or fly ash) using a hollow stem paddle mixer to achieve stabilization. As the soil-mixing tool is drilled into the ground, grout slurry is pumped through the stem and injected through the nozzles of the rotating blades. When the design depth is reached, the tool is withdrawn, leaving grouted soil column (soilcrete). Since the groundwater is encountered at shallow depth, we recommend that the Wet Soil Mixing method be used.

These methods involve in-situ treatment of the soils without any groundwater extraction; therefore, groundwater treatment and off-site disposal would not be required. Any soil remediation design and future geotechnical investigations need to take into account the contaminated groundwater at the site and must be approved by NASA to ensure that the contamination is not spread or migrated into areas that are currently not contaminated. The soil remediation and future geotechnical investigations must also not interfere with the Navy's remedial measures to clean up the ground water contamination and must take into account the constraints in the USEPA MEW Study Area Record of Decision Amendment for the Vapor Intrusion Pathway. The improvement can be limited to areas around the existing pile foundations and gates and at other foundation locations proposed for new facilities. If seismic-induced lateral soil movements are anticipated, the improvement can be extended along the building's perimeter to resist these movements.

Due to the limited information available to date, final design and layout of the required improvement cannot be determined at this time. Additional soil investigations are needed to better characterize subsurface conditions and to determine extent of improvement. The improvement method, type of grout and diameter and spacing of soilcrete columns should be determined after further consultation with ground improvement contractor(s). Impacts of vibration and settlement on the existing foundations and building overhead limitations should also be evaluated.

The structural analysis and evaluation of the building is based on soil site class D forces and no appreciable differential settlement due to liquefaction. The geotechnical portion of the report, however, identifies the possibility of soil liquefaction and therefore requires soil remediation to meet the site class D forces. The building may be alternately evaluated with an additional non-linear structural analysis based on additional site specific geotechnical analysis, which may result in both reduced expected settlements and amplified accelerations. The non-linear analysis method may be included as a value engineering (VE) option for the final design which may reduce the amount of steel needing retrofitting as well as reducing the

amount of required soil remediation. The approach used in this report is intended to meet current building codes and standards, however it does not include all possible analysis methods. Based on the information available at the time of this study, the approach used in the geotechnical analysis portion of this report is conservative with regards to the settlement potential in order to capture the maximum probable required soil and steel mitigation.

5.E Design Soil Engineering Parameters

Analysis soil profile and engineering parameters were developed based on the available data and information, especially those obtained from the CPT soundings. The soil engineering parameters were estimated from the recorded cone penetration resistances using published empirical relationships. Table 5-3 lists our recommended soil profile and engineering parameters for analysis and design.

Note that the recommended soil parameters for the sandy and gravelly soils are for *non-liquefied soils (i.e., these soils are mitigated as discussed in Section 5.D.4)*; failure to mitigate soil liquefaction will result in different values than those shown below.

Soil Type	Depth Range	γ	Shear Strength Parameters	
			c	φ
	feet bgs	pcf	psf	degrees
Upper sandy/gravelly silt	0-15	120	0	38
Upper silty clay	15-30	115	1600	0
Silty sand and gravel	30-35	120	0	36
Lower silty clay	> 35	115	2000	0

Table 5-3 Design Soil Profile and Parameters

5.F Pile Foundation

Based on the available drawings, the building is founded on pile caps that are supported by 16-inch square, 36 feet long, precast concrete piles. Some of the piles are battered to provide stiffer resistance in the horizontal direction. Both the axial and lateral capacities of a single pile, as well as load-displacement relations of the pile caps, were calculated in support of the dynamic structural response analysis of the building.

5.F.1 Single Pile Capacity

The axial and lateral capacities of a single pile were estimated using the soil profile and non-liquefied engineering parameters listed in Table 5-4. We used the computer programs Driven (version 1.2, Blue-Six Software, Inc., 2001) for axial capacity and FB-Multiplier (version 4, Florida Bridge Software Institute, 2000) for lateral capacity calculations of a single pile.

Minimum Safety Factors of 3.0 and 1.5 are recommended for static gravity and transient (seismic and wind) loads, respectively. Uplift axial capacity was determined based on the frictional capacity of soils, limited to a maximum of 65 percent of the downward frictional capacity. For laterally loaded pile, the allowable capacity is limited to the load that results in about half-inch of lateral deflection at the pile's top. Table 5-4 below summarizes the allowable axial and lateral capacities of a single pile.

Pile Type	Allowable Axial, kips		Lateral ¹ , kips
	Compression	Uplift	
Vertical Pile			
Static gravity	90	58	45
Transient	175	114	
Battered Pile			
Static gravity	85	55	50
Transient	160	105	

Note: ¹: Load that results in about half-inch of pile top deflection

Table 5-4 Axial and Lateral Capacities of a Single Pile

For piles in a group, the group capacity is typically less than the sum of the individual capacity. The pile group capacity should be evaluated on a case-by-case basis, depending on the cap and pile configurations and block capacity and settlement. For preliminary analysis, however, the reduction factors listed in Table 5-5 can be applied to the single pile capacity to account for group effects.

Pile Capacity	Reduction Factor			
	2.5D	3D	5D	8D
Axial Capacity	0.9	1.0	1.0	1.0
Lateral Capacity (Parallel to Loading)	0.6	0.7	0.9	1.0

Note: D: least dimension of pile

For spacing between those provided, a linear interpolation may be utilized to calculate the reduction factor.

Table 5-5 Reduction Factors to Account for Group Effects

5.E.2 Pile Group Stiffness

For this study, we developed the relations for the two pile groups that support Arch #6: Pile Groups A-1 and A-2. Pile Group A-1 is an 8.5-feet by 8.5-feet, 4-foot thick, square pile cap supported by 9 vertical piles. Pile Group A-2 consists of an 8.5-feet by 11.5-ft, 4 feet thick, rectangular pile cap supported by 4 vertical piles and 8 battered piles. Figure 5-6 shows the schematic drawings of these two pile groups.

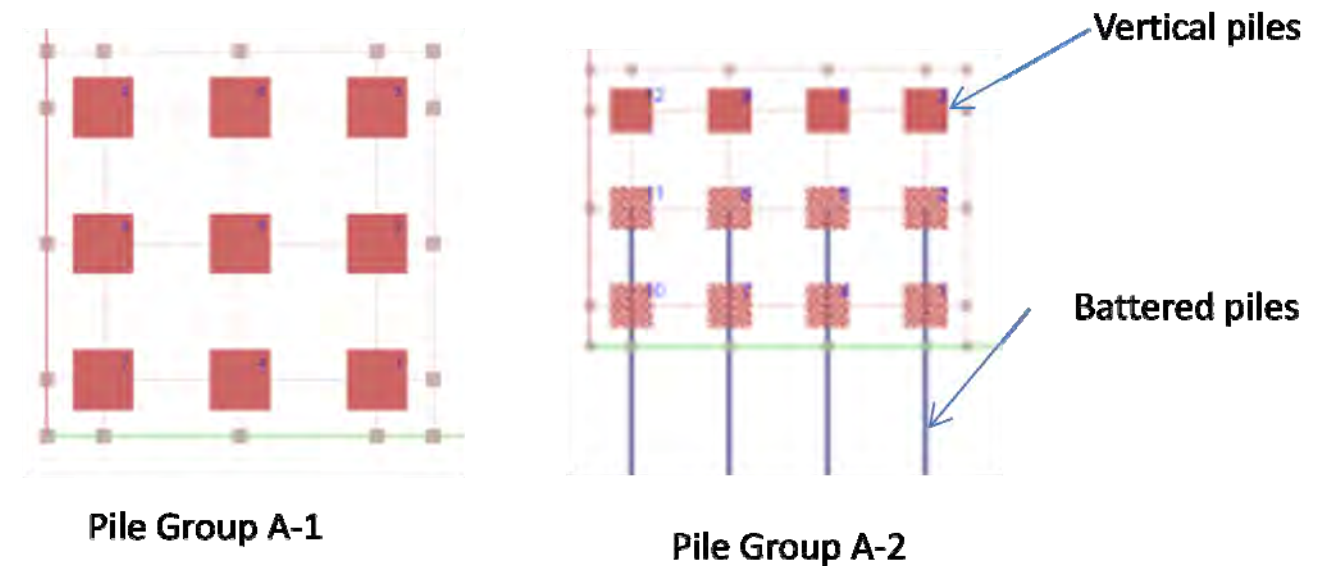

FIGURE 5-6 SCHEMATIC DRAWINGS OF PILE GROUPS A-1 AND A-2

We used the computer programs FB-Multiplier (version 4, Florida Bridge Software Institute, 2000) to calculate the load-displacement relationships of a pile group. In the analysis, the pile and pile cap elastic cross sectional properties were used, the loads were applied individually (separately) in each direction, and a pile-to-pile cap pinned connection was assumed. Figures 5-7 through 5-10 depict the calculated load-displacement relationships of these two pile groups.

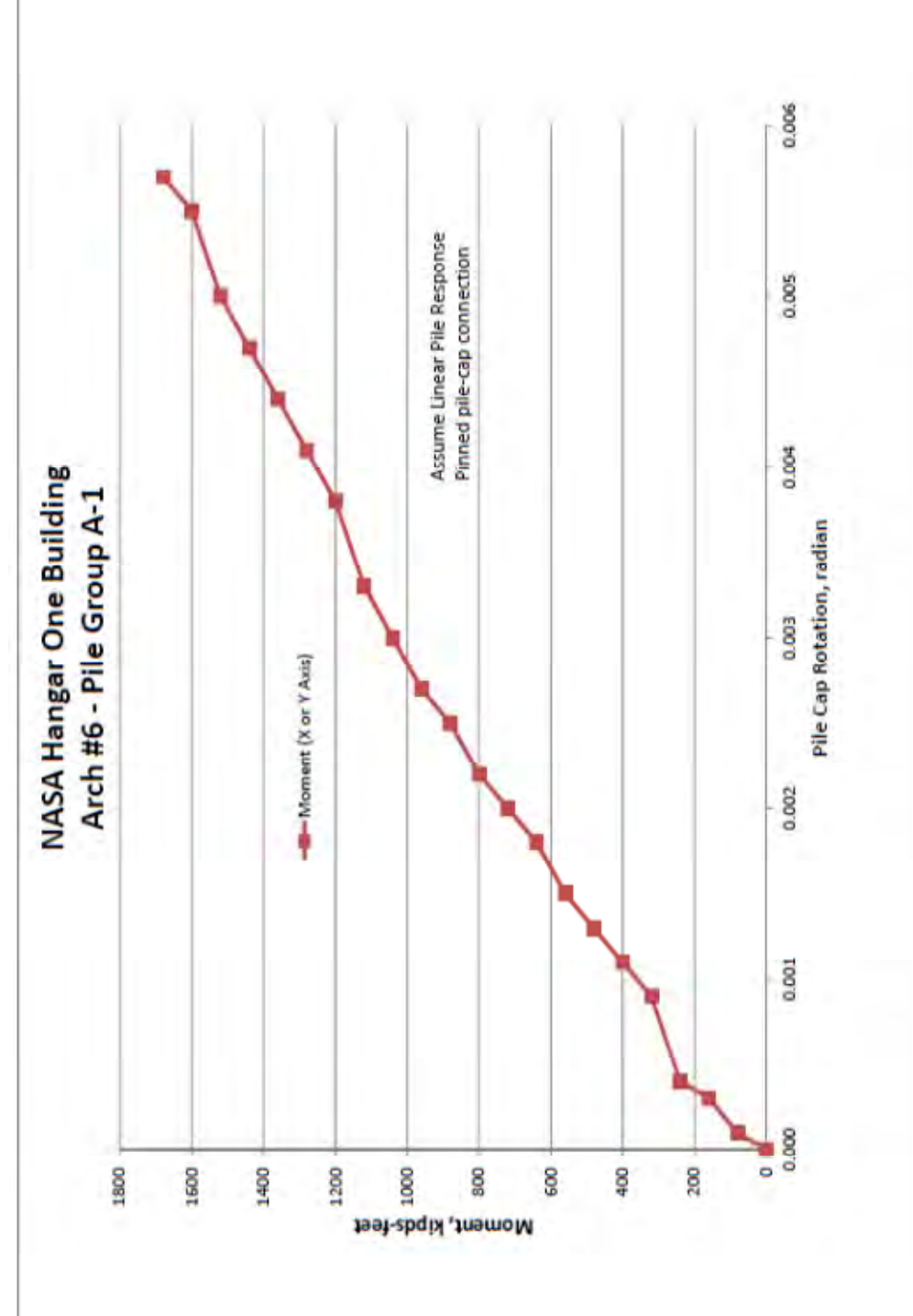
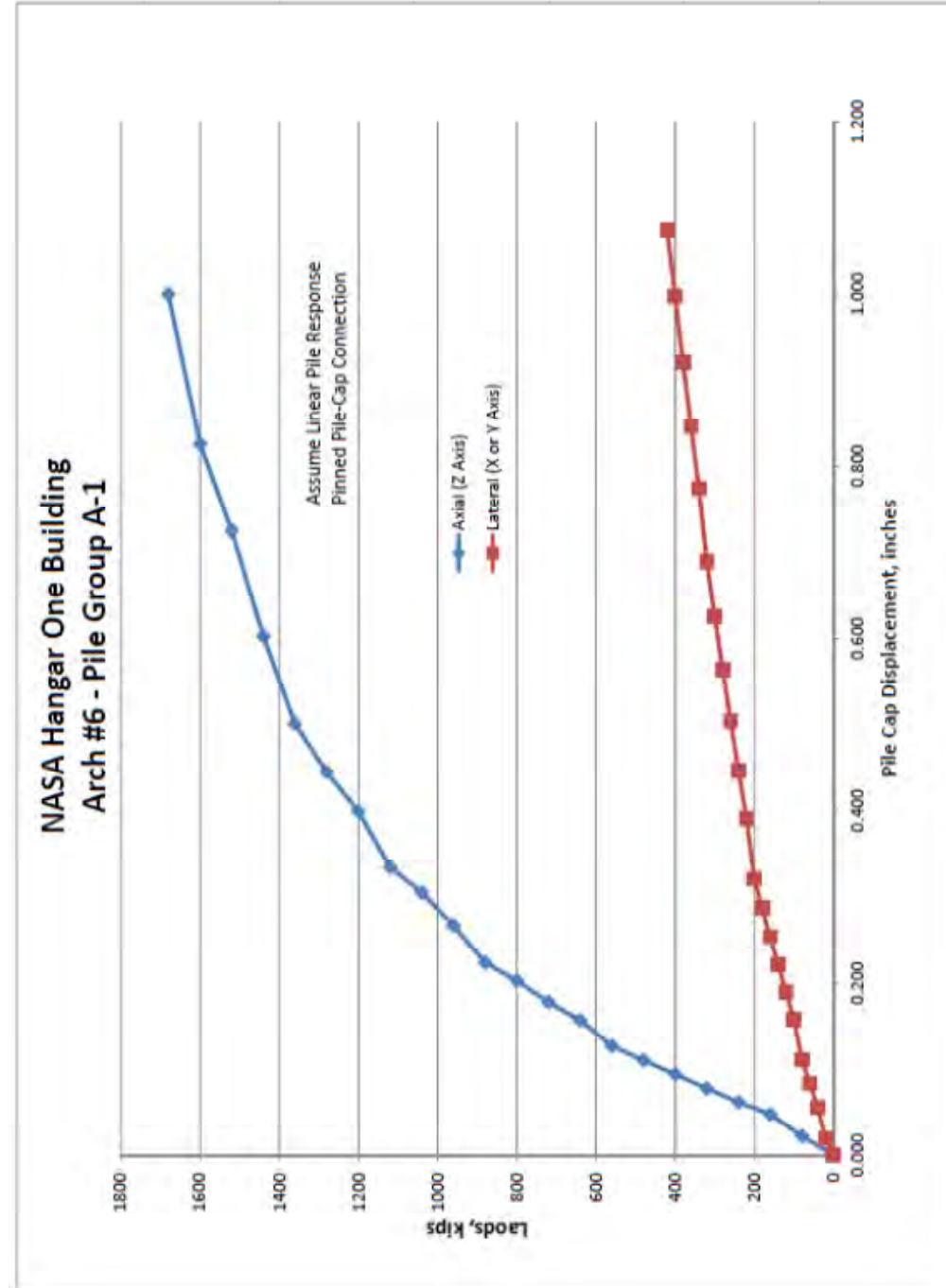

FIGURE 5-7
Load-Displacement Relationship for Pile Group A-1 (Axial and Lateral Axis)
(x-axis: building's transverse direction, y-axis: building's longitudinal direction)

Figure 5-8
Load-Displacement Relationship for Pile Group A-1 (Moment)
(x-axis: building's transverse direction, y-axis: building's longitudinal direction)

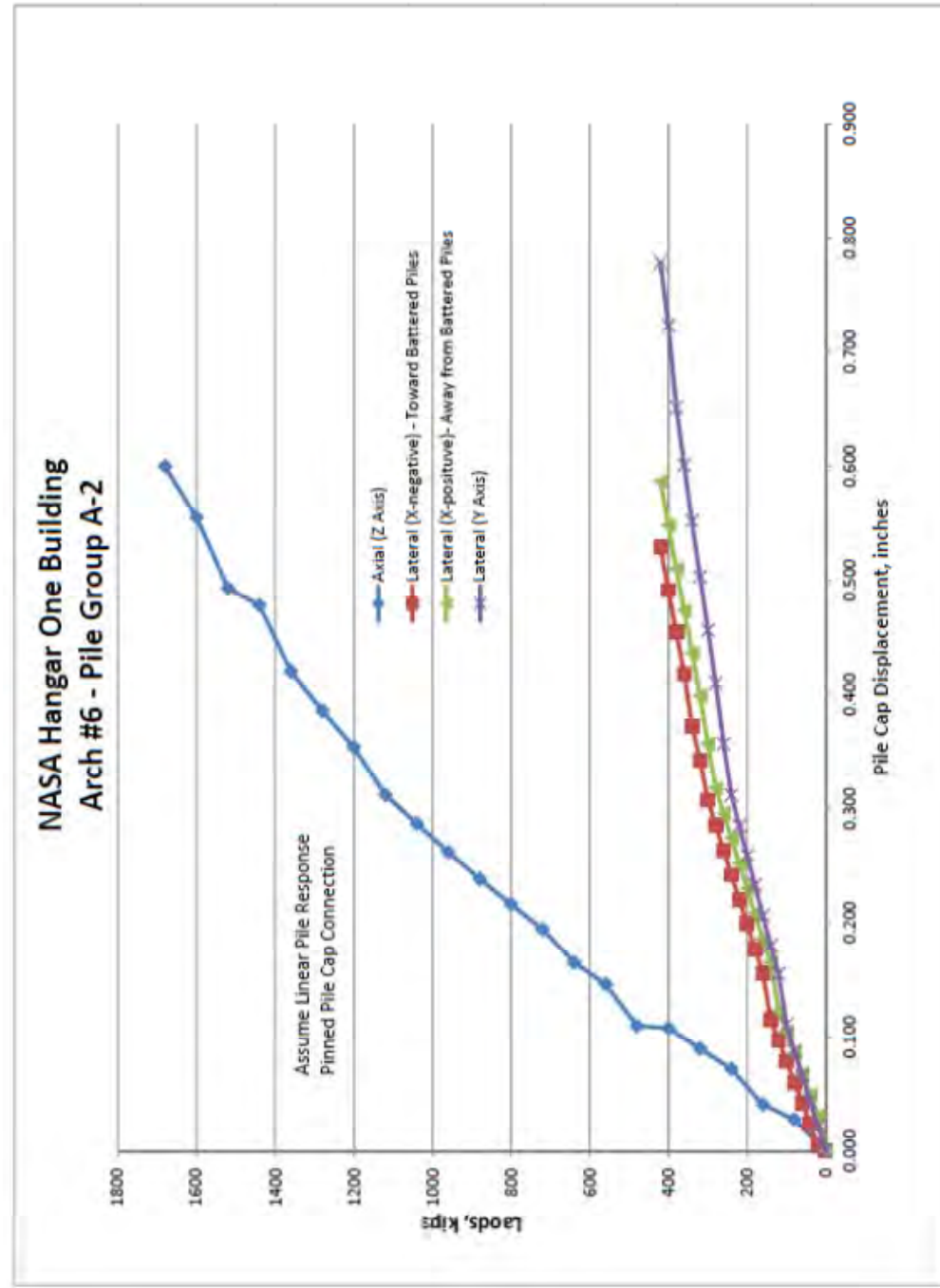

Figure 5-9
 Load-Displacement Relationship for Pile Group A-2 (Axial and Lateral Axis)
 (x-axis: building's transverse direction, y-axis: building's longitudinal direction)

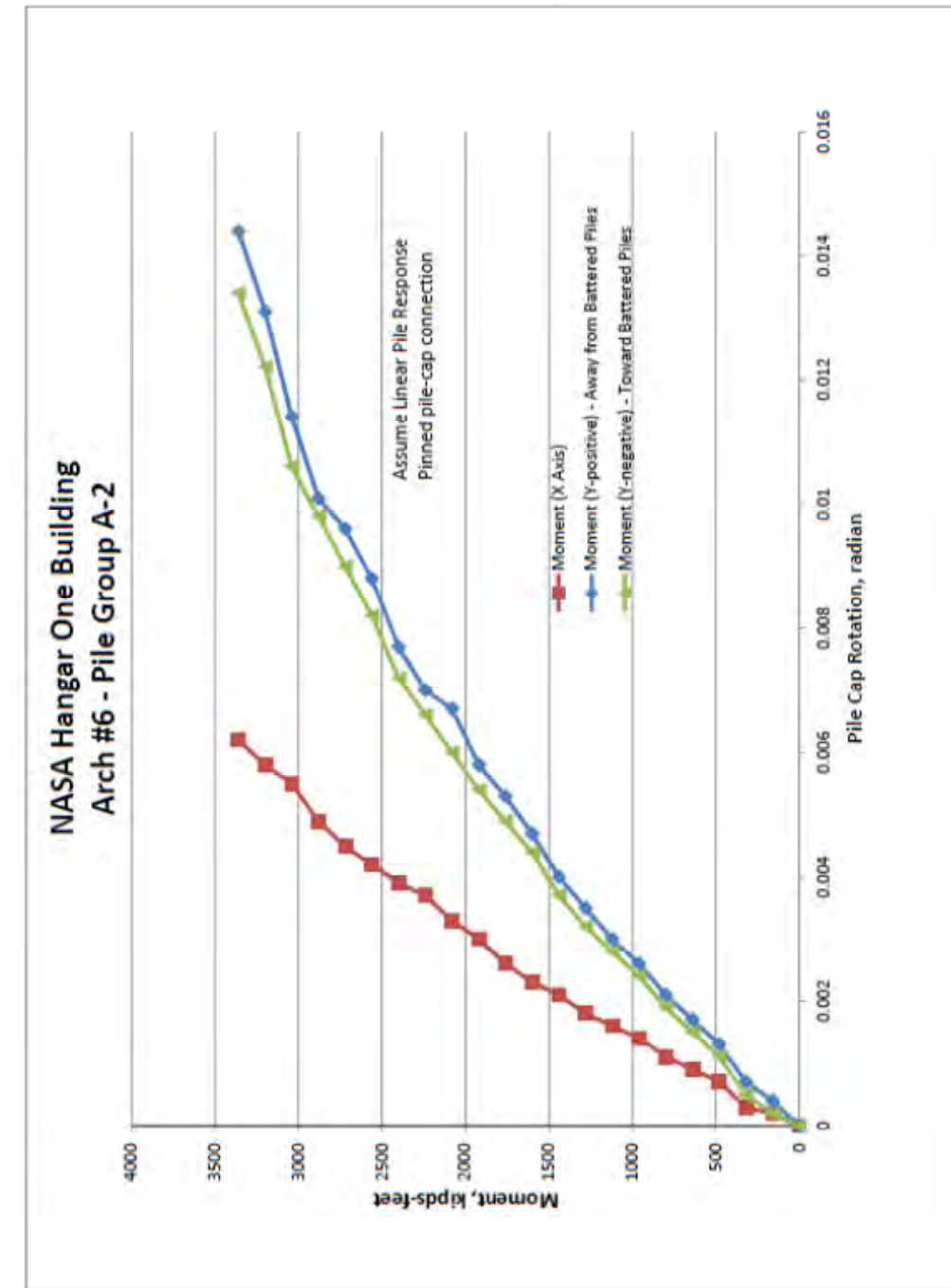

FIGURE 5-10
 Load-Displacement Relationship for Pile Group A-2 (Moment)
 (x-axis: building's transverse direction, y-axis: building's longitudinal direction)

5.G References

- California Geological Survey (CGS). 2002. California Geomorphic Provinces Note 36
- California Geological Survey (CGS). 2006. Seismic Hazard Zone Report for the Mountain View 7.5-Minute Quadrangle, Santa Clara, Alameda and San Mateo Counties, California. Seismic Hazard Zone Report 060 (Revised)
- Helley, E.J. and K.R. Lajoie. 1979. Flatland deposits of the San Francisco Bay Region, California – Their Geology and Engineering Properties and Their Importance to Comprehensive Planning, U.S. Geological Survey (USGS) Professional Paper 943
- Lajoie, K.R. and E.J. Helley. 1975. Differentiation of Sedimentary Deposits for Purposes of Seismic Zonation, *In* Borchardt, R.D. (ed.), Studies for Seismic Zonation of the San Francisco Bay Region, U.S. Geological Survey (USGS) Professional Paper 941-A
- U.S. Geological Survey (USGS). 2004. Documentation of the Santa Clara Valley Regional Groundwater/Surface Water Flow Model, Santa Clara County, California, USGS Scientific Investigations Report, 2004-5231

5.G Attachment A: Available CPT and Well Logs



TETRA TECH

Site : MOFFETT FIELD
Location : W0-CPT1

Geologist : J. JACKSON
Date : 09:29:03 08:34

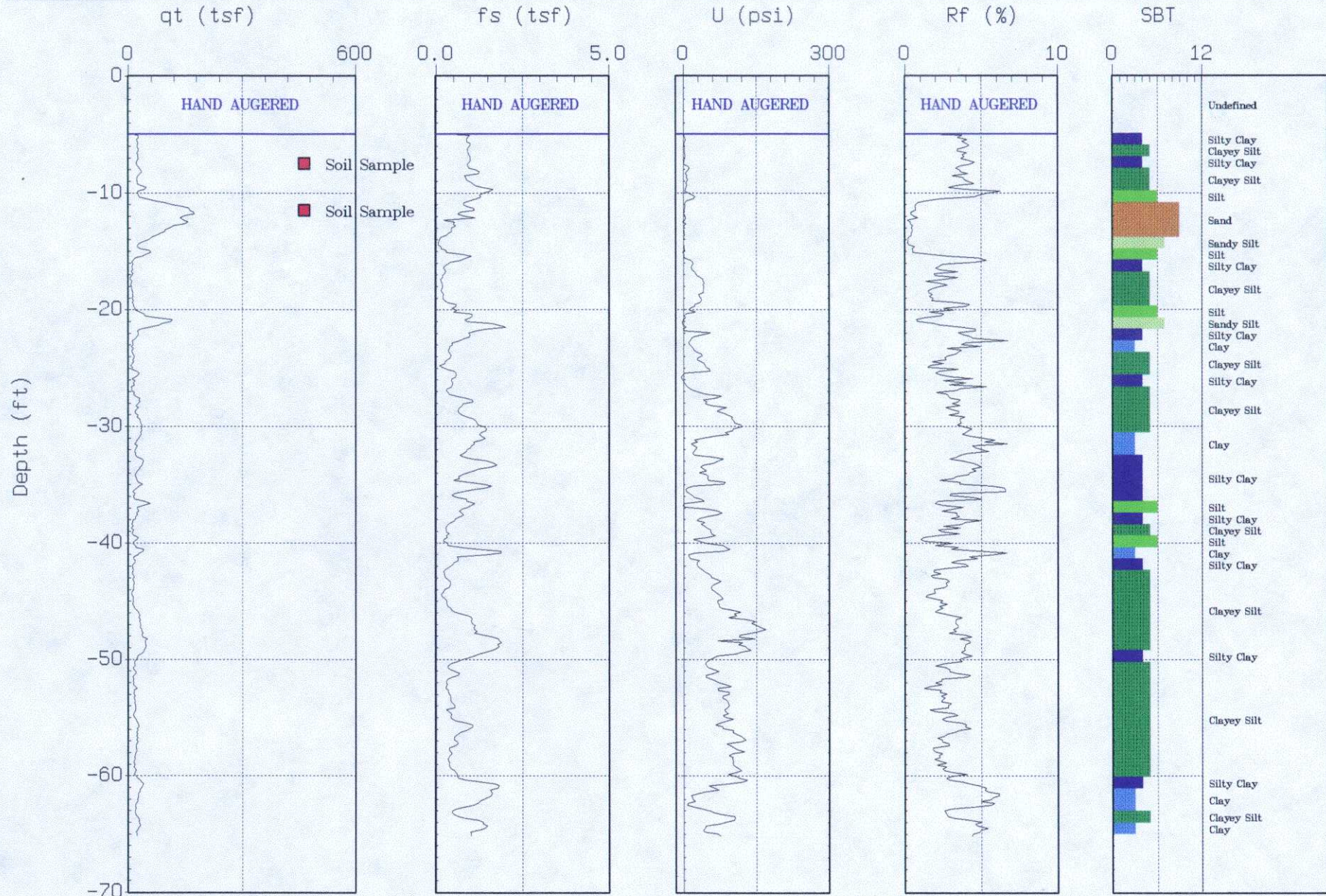

Max. Depth: 65.12 (ft)

Depth Inc.: 0.164 (ft)

SBT: Soil Behavior Type (Robertson 1990)



TETRA TECH

Site : MOFFETT FIELD
Location : W0-CPT2

Geologist : J. JACKSON
Date : 09:29:03 10:19

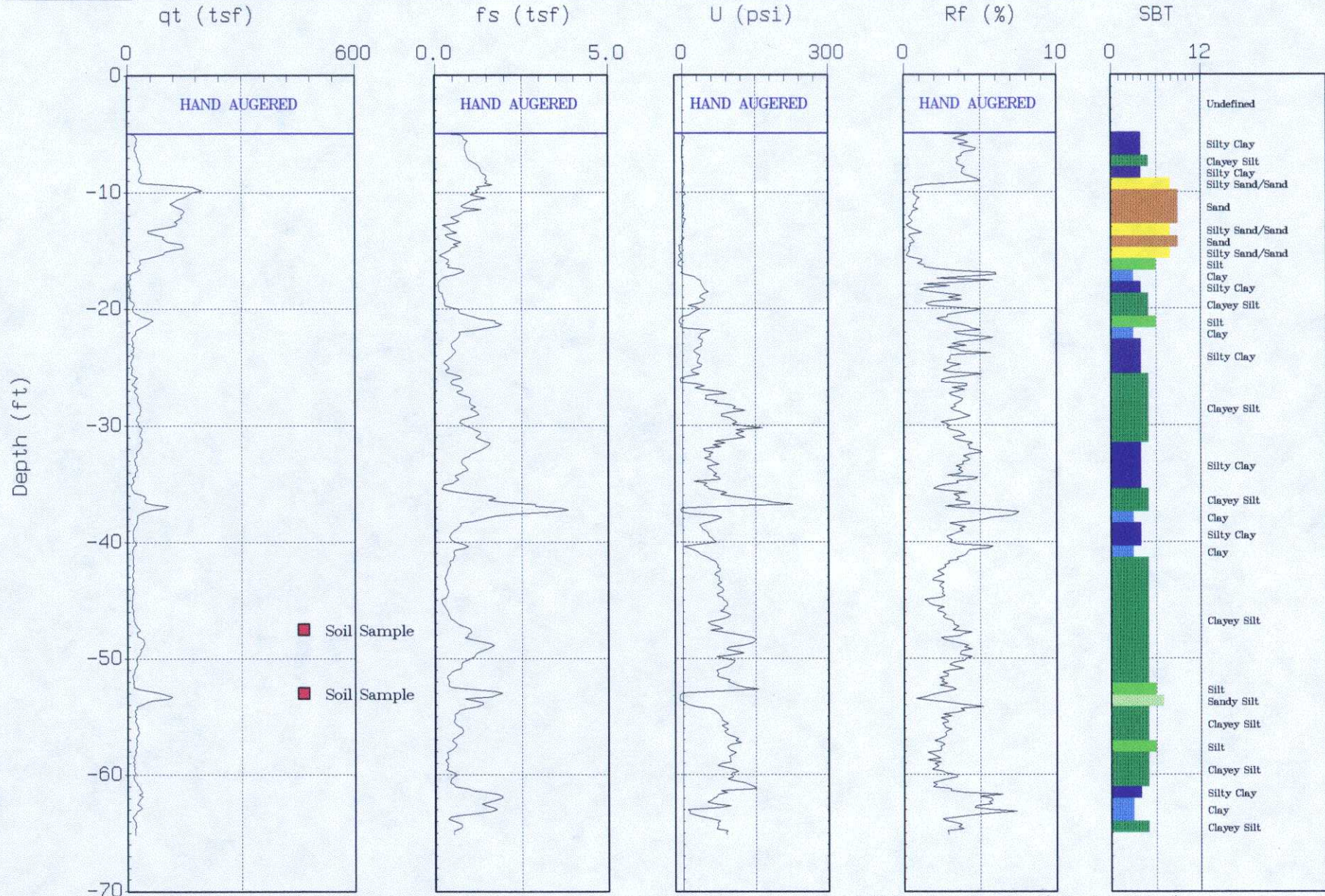

Max. Depth: 65.12 (ft)

Depth Inc.: 0.164 (ft)

SBT: Soil Behavior Type (Robertson 1990)



TETRA TECH

Site : MOFFETT FIELD
Location : W0-CPT3

Geologist : J. JACKSON
Date : 09:29:03 12:35

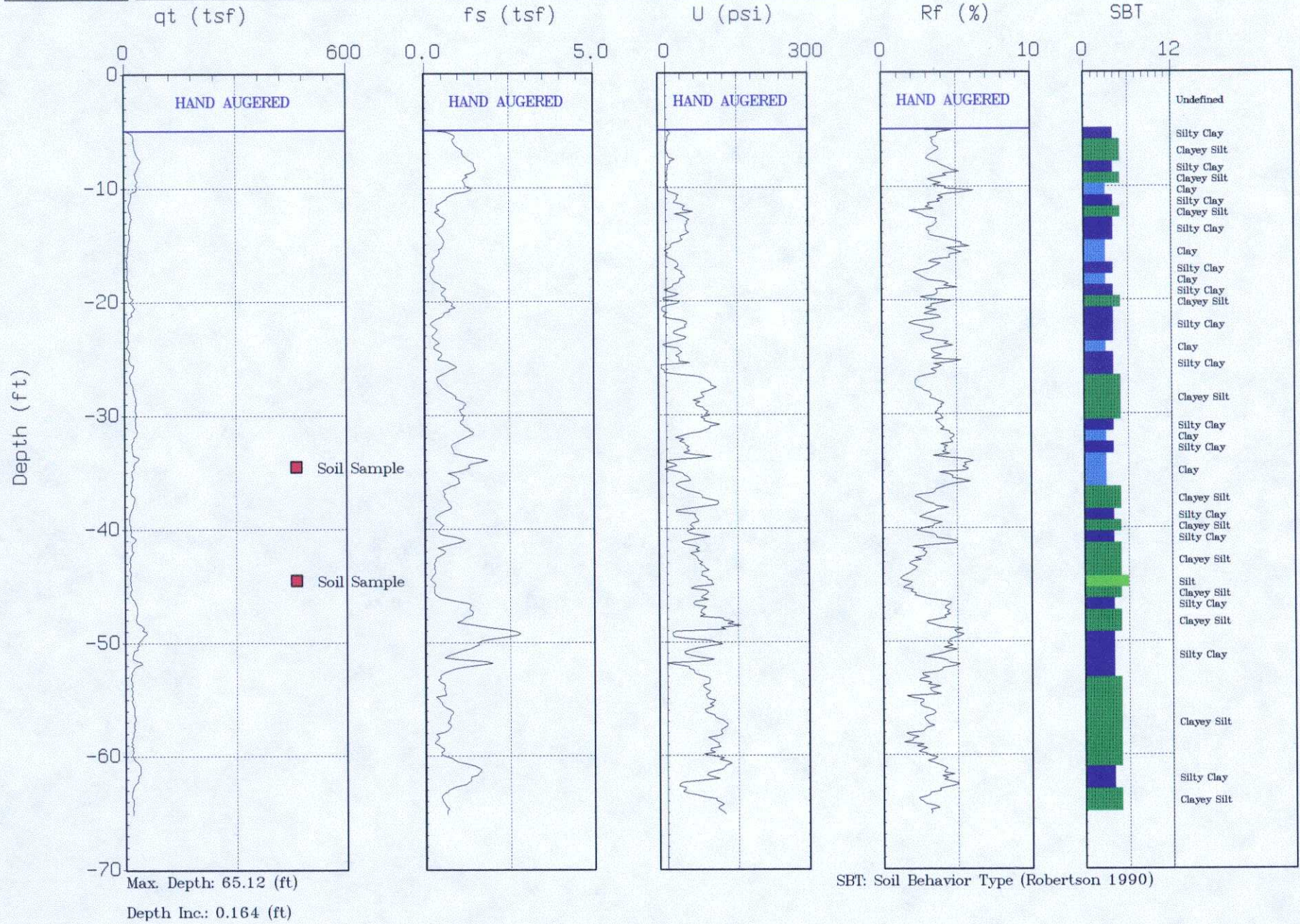



TETRA TECH

Site : MOFFETT FIELD
Location : W0-CPT4

Geologist : J. JACKSON
Date : 09:30:03 08:49

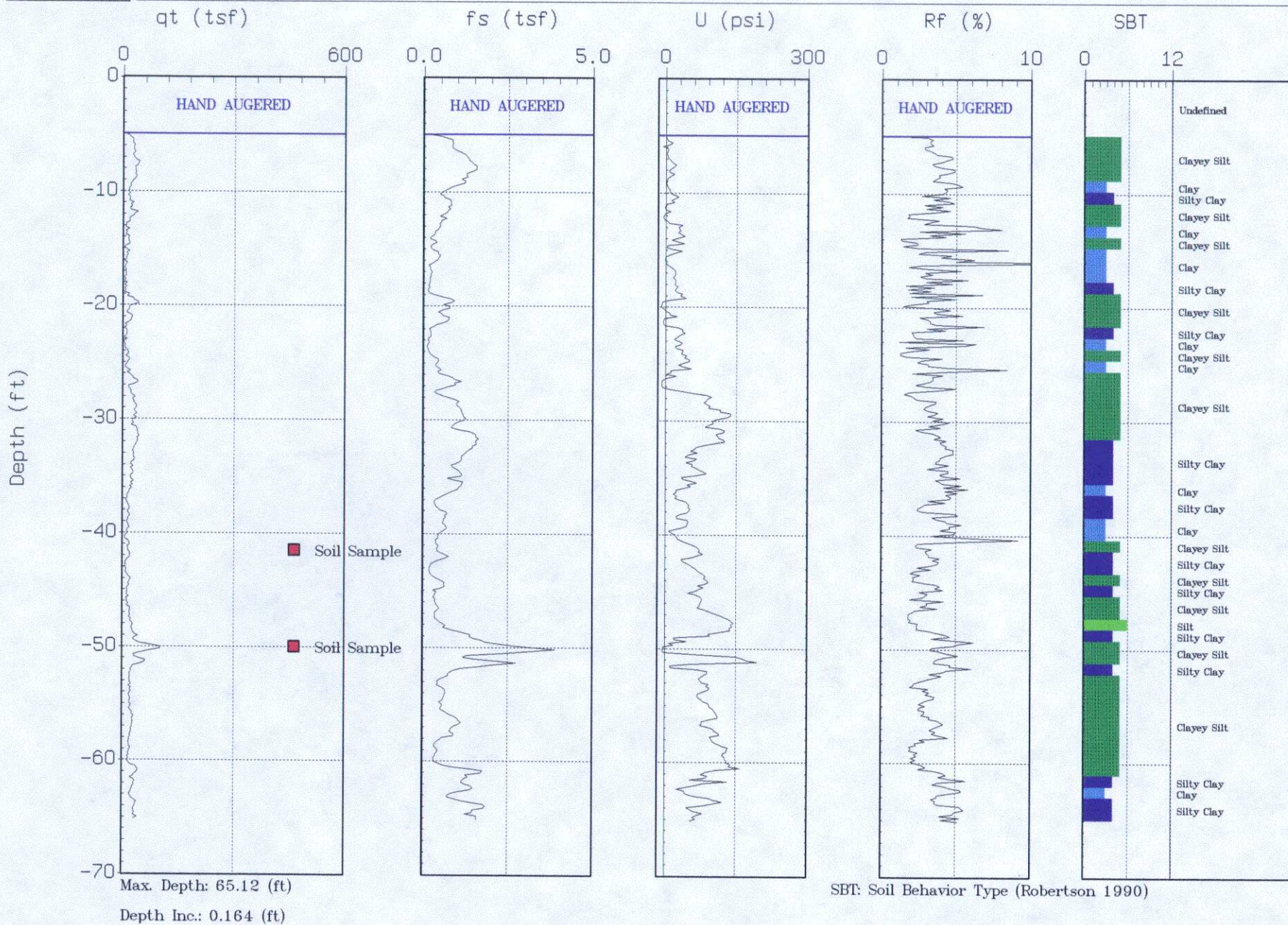



TETRA TECH

Site : MOFFETT FIELD
Location : W0-CPT6

Geologist : J. JACKSON
Date : 09:30:03 12:54

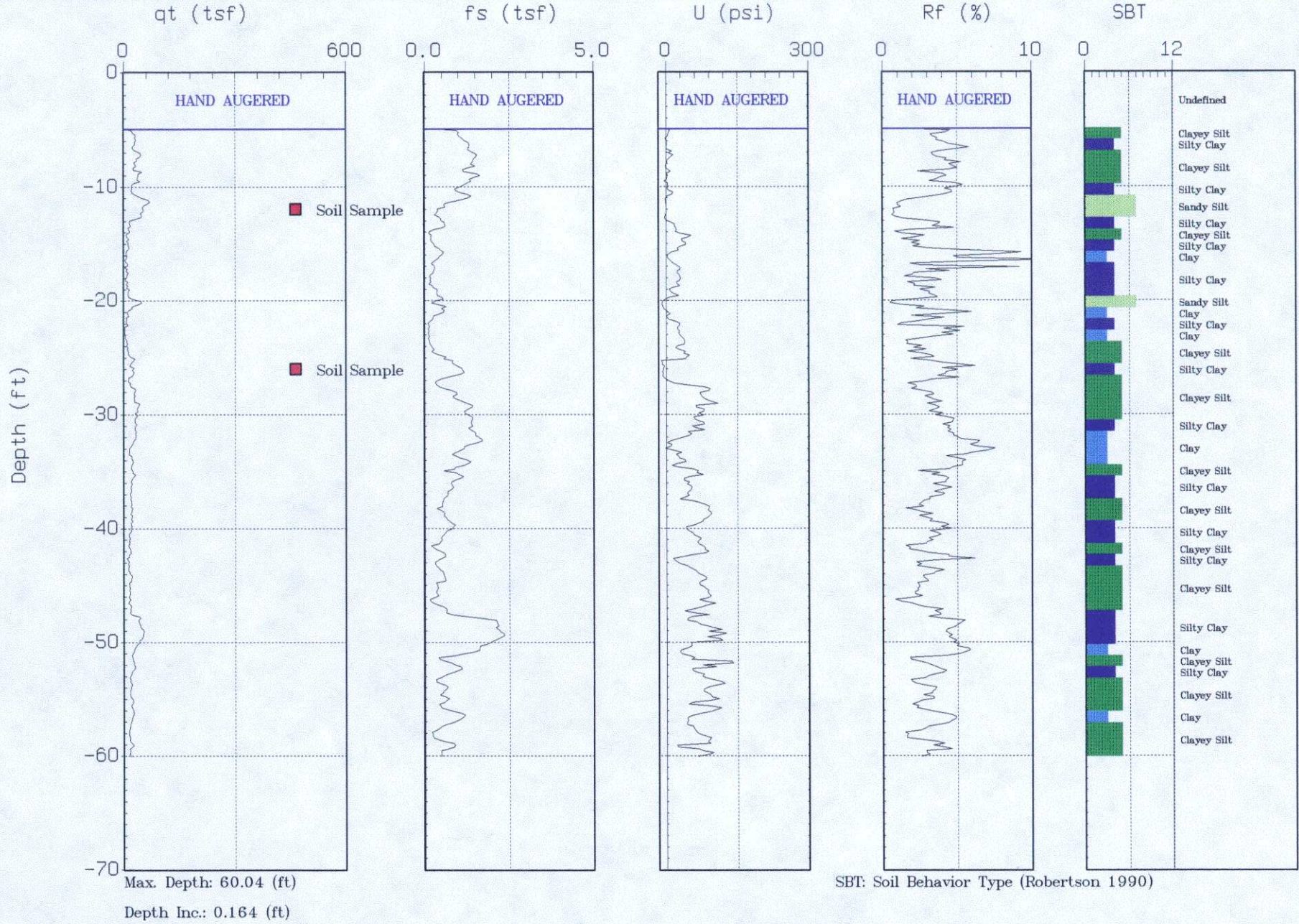



TETRA TECH

Site : MOFFETT FIELD
Location : W0-CPT7

Geologist : J. JACKSON
Date : 09:30:03 14:30

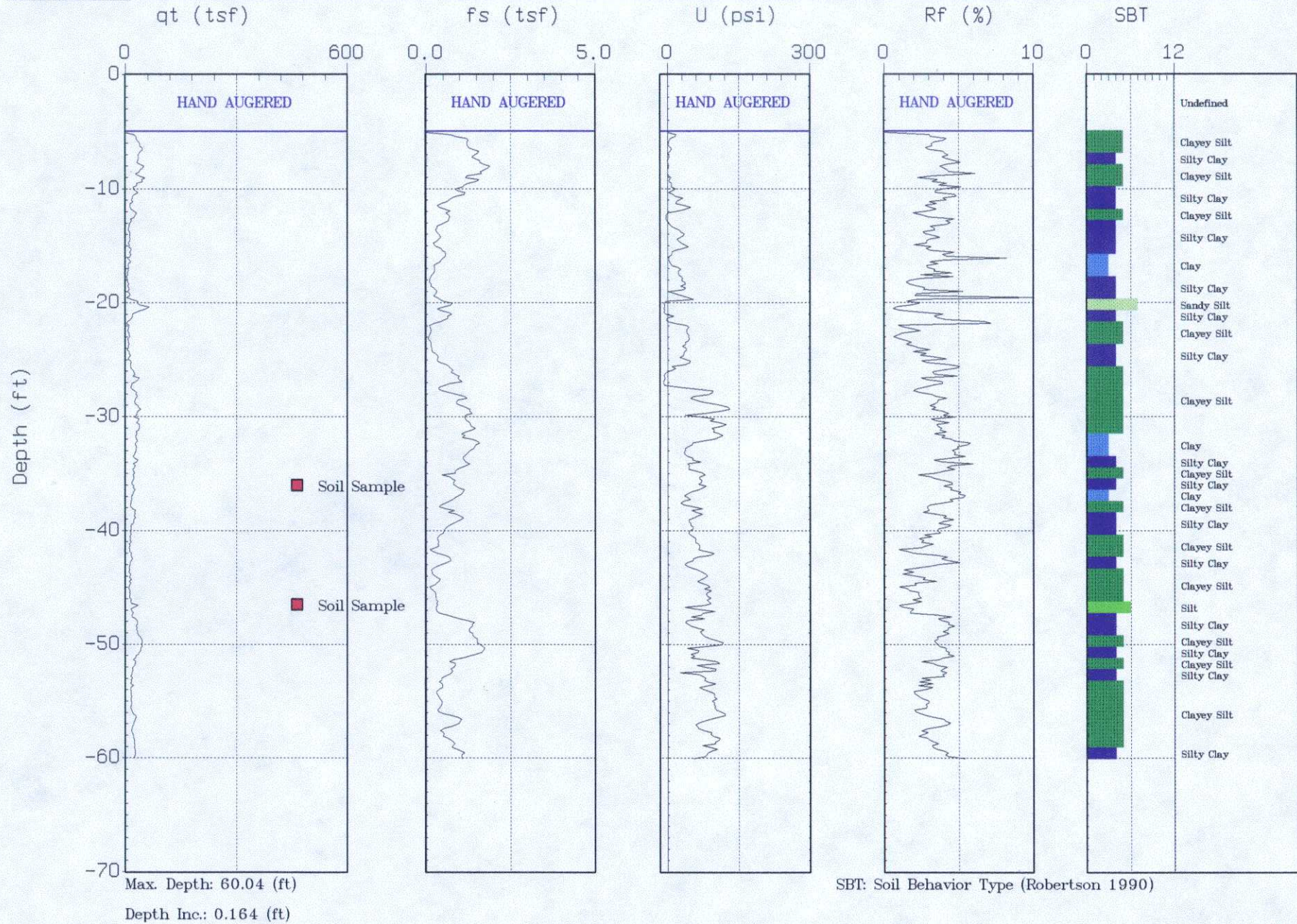



TETRA TECH

Site : MOFFETT FIELD
Location : WO-CPT8

Geologist : J. JACKSON
Date : 10:01:03 08:08

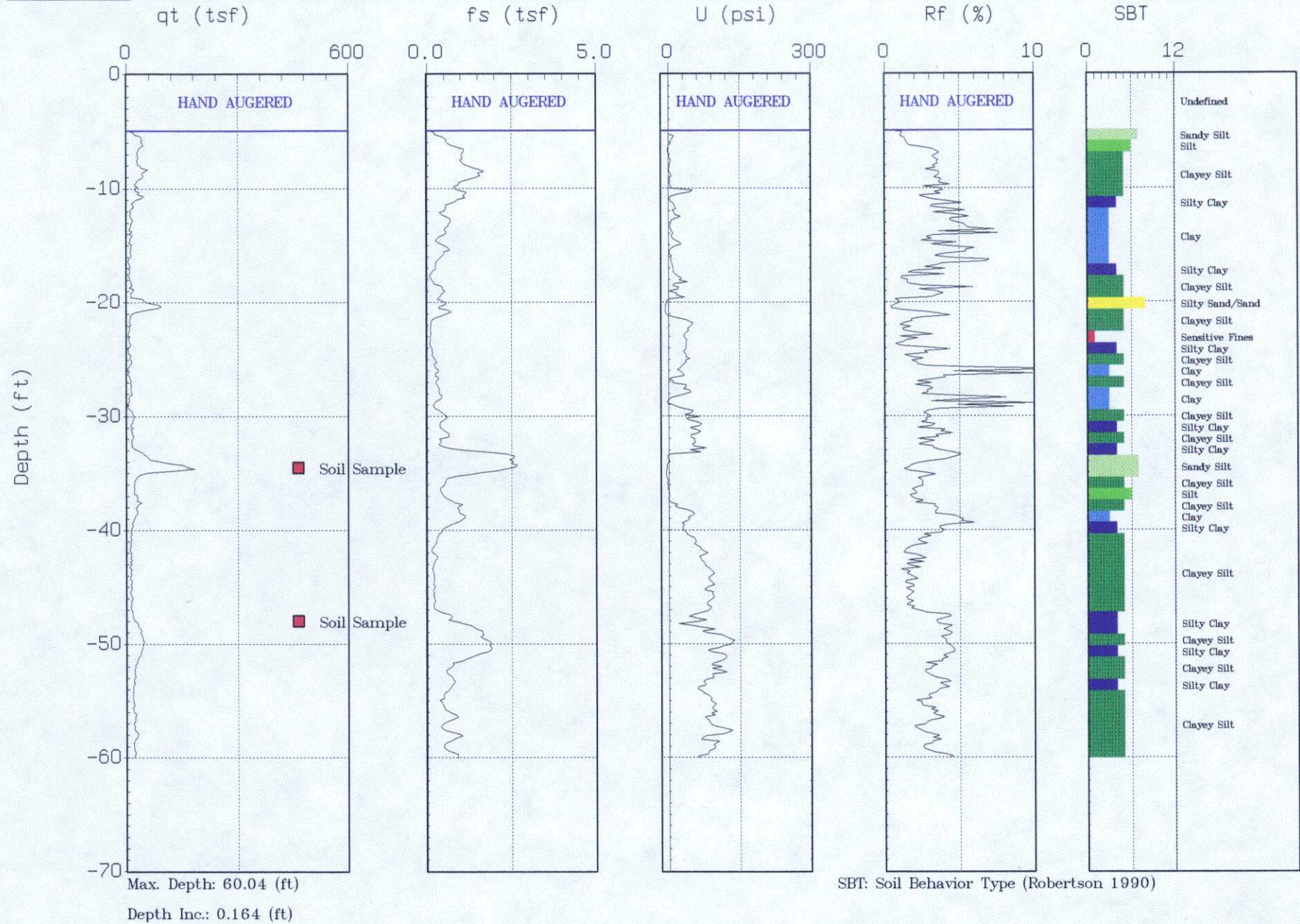



TETRA TECH

Site : MOFFETT FIELD
Location : WO-CPT9

Geologist : J. JACKSON
Date : 10:01:03 09:45

qt (tsf)

fs (tsf)

U (psi)

Rf (%)

SBT

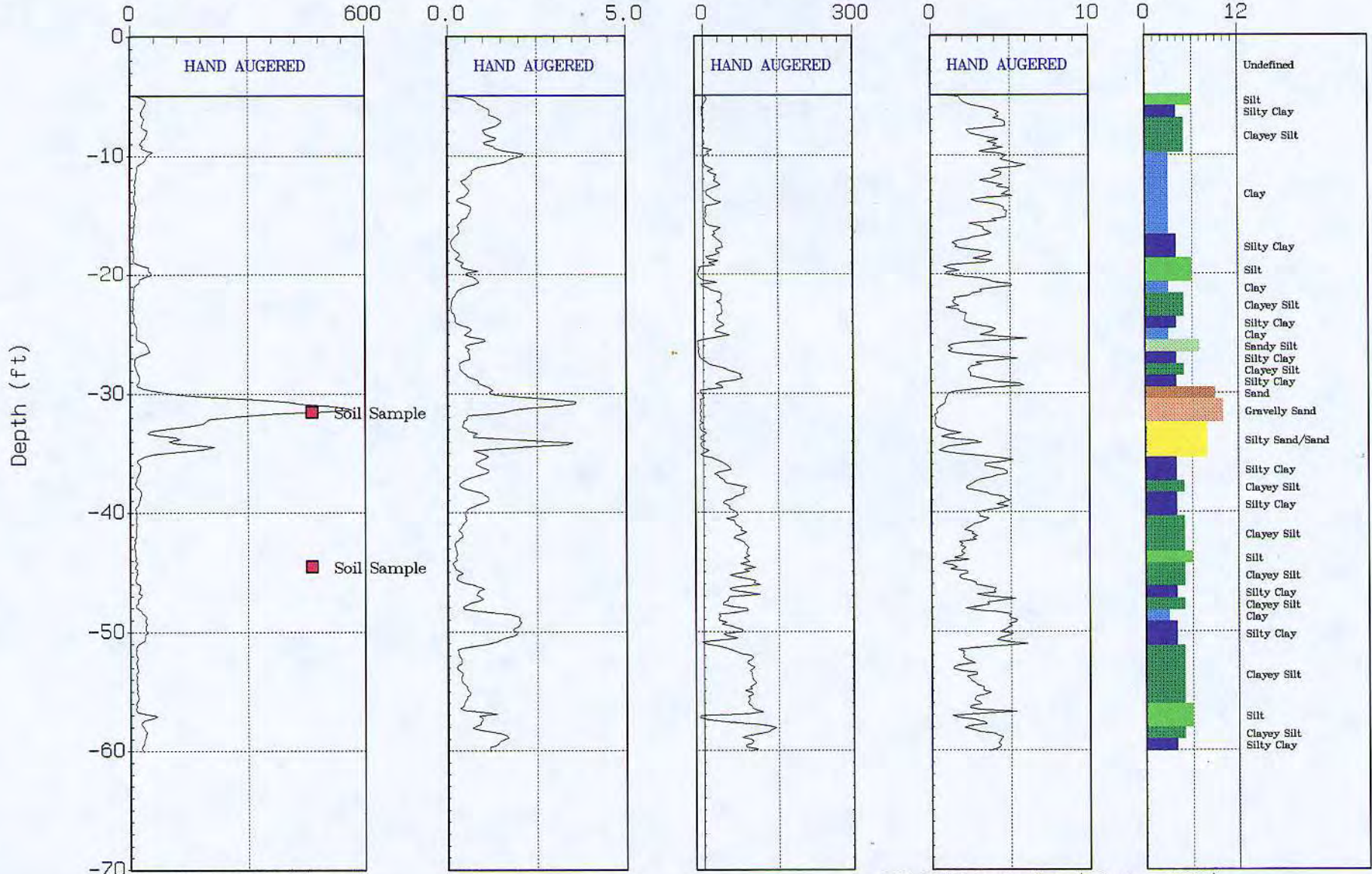

Max. Depth: 60.04 (ft)

Depth Inc.: 0.164 (ft)

SBT: Soil Behavior Type (Robertson 1990)

- Undefined
- Silt
- Silty Clay
- Clayey Silt
- Clay
- Silty Clay
- Silt
- Clay
- Clayey Silt
- Silty Clay
- Clay
- Sandy Silt
- Silty Clay
- Clayey Silt
- Silty Clay
- Sand
- Gravelly Sand
- Silty Sand/Sand
- Silty Clay
- Clayey Silt
- Silty Clay
- Clayey Silt
- Silt
- Clayey Silt
- Silty Clay
- Clayey Silt
- Clay
- Silty Clay
- Clayey Silt
- Silt
- Clayey Silt
- Silty Clay



TETRA TECH

Site : MOFFETT FIELD
Location : W0-CPT10

Geologist : J. JACKSON
Date : 10:01:03 11:00

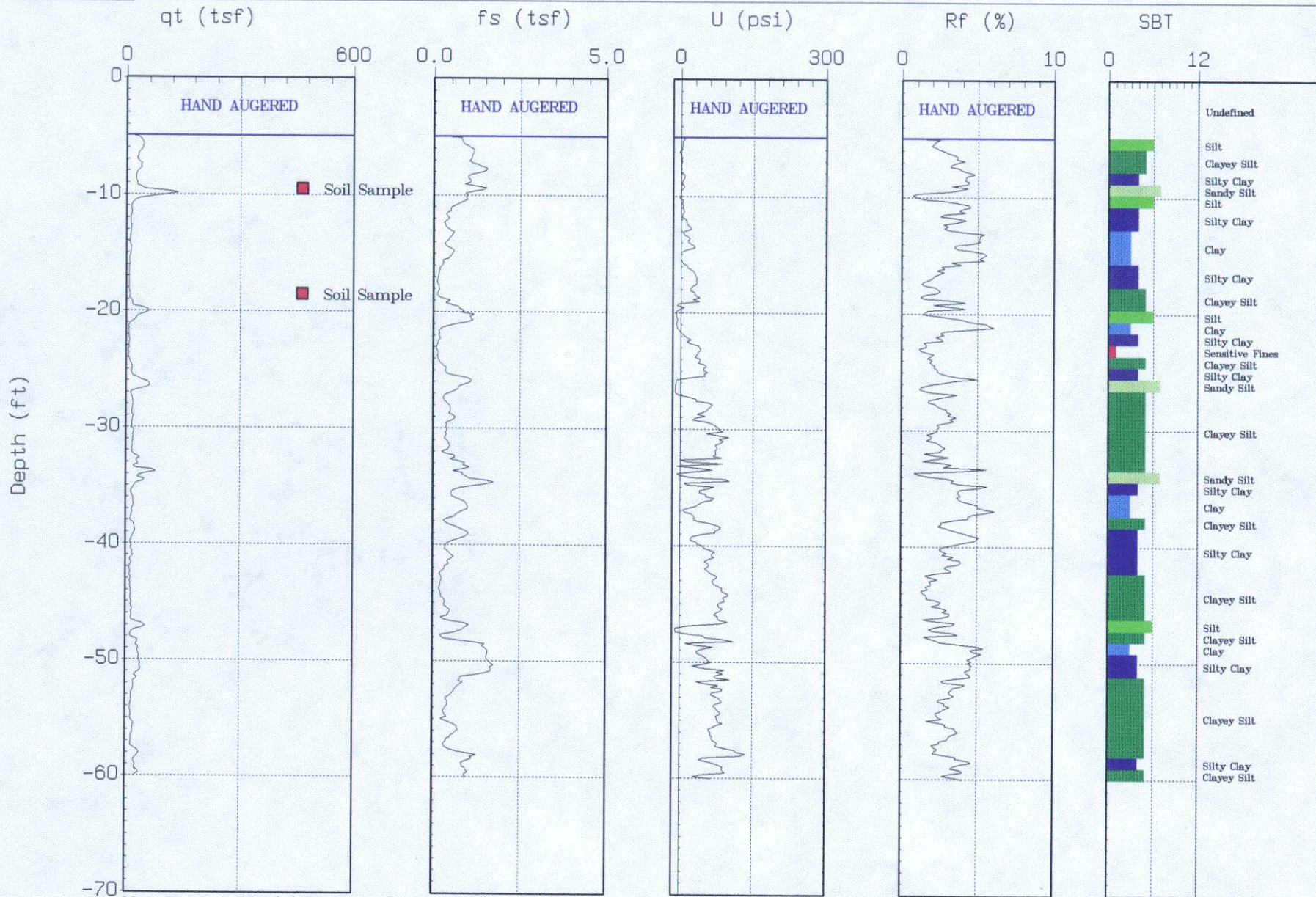

Max. Depth: 60.04 (ft)

Depth Inc.: 0.164 (ft)

SBT: Soil Behavior Type (Robertson 1990)



TETRA TECH

Site: WATS OPT BLDG 88
Location: CPT-88-7

Geologist: L.DUDUS
Date: 04:11:05 14:15

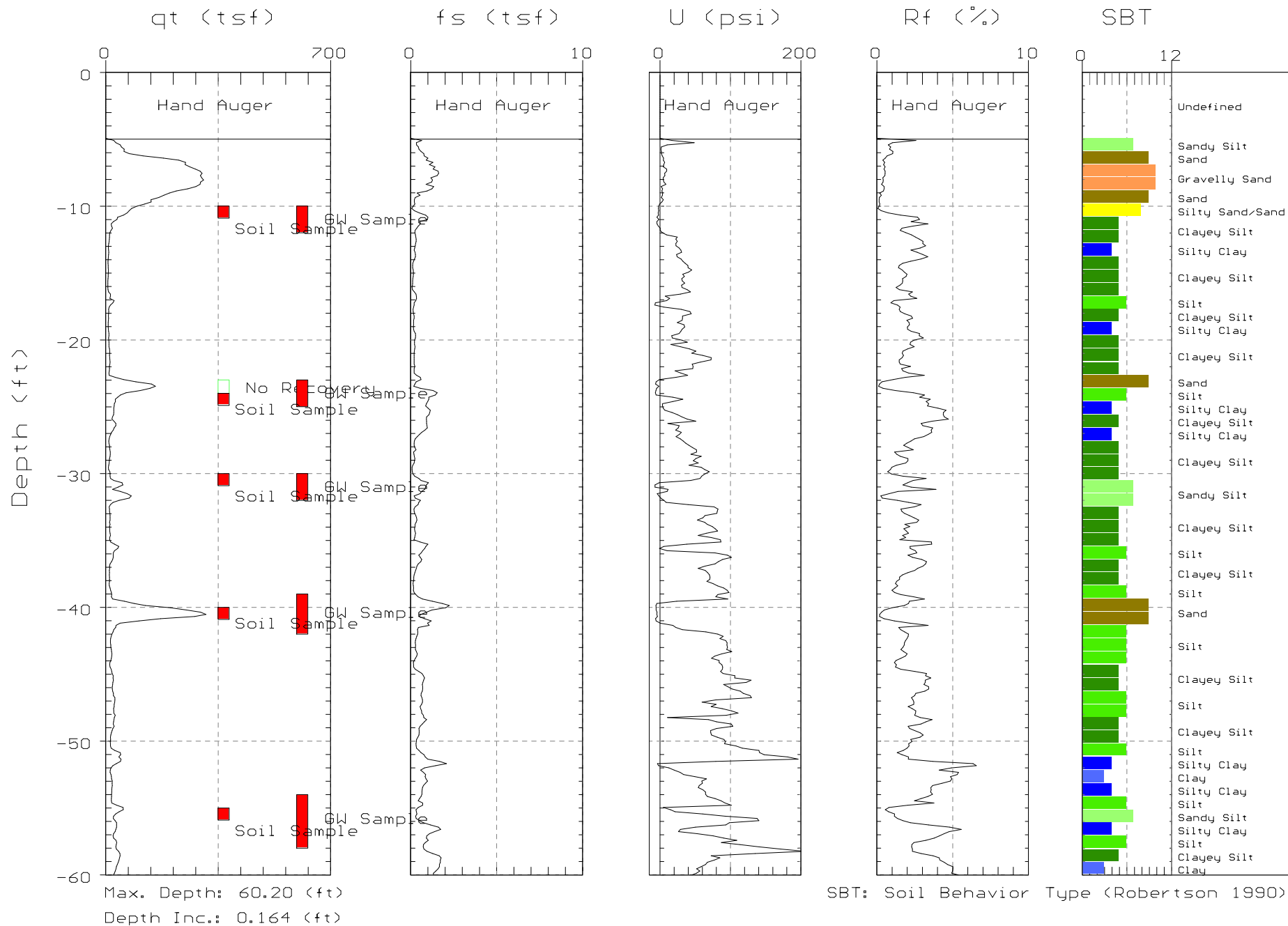



TETRA TECH

Site: WATS OPT BLDG 88
Location: CPT-88-8

Geologist: L.DUDUS
Date: 04:11:05 15:31

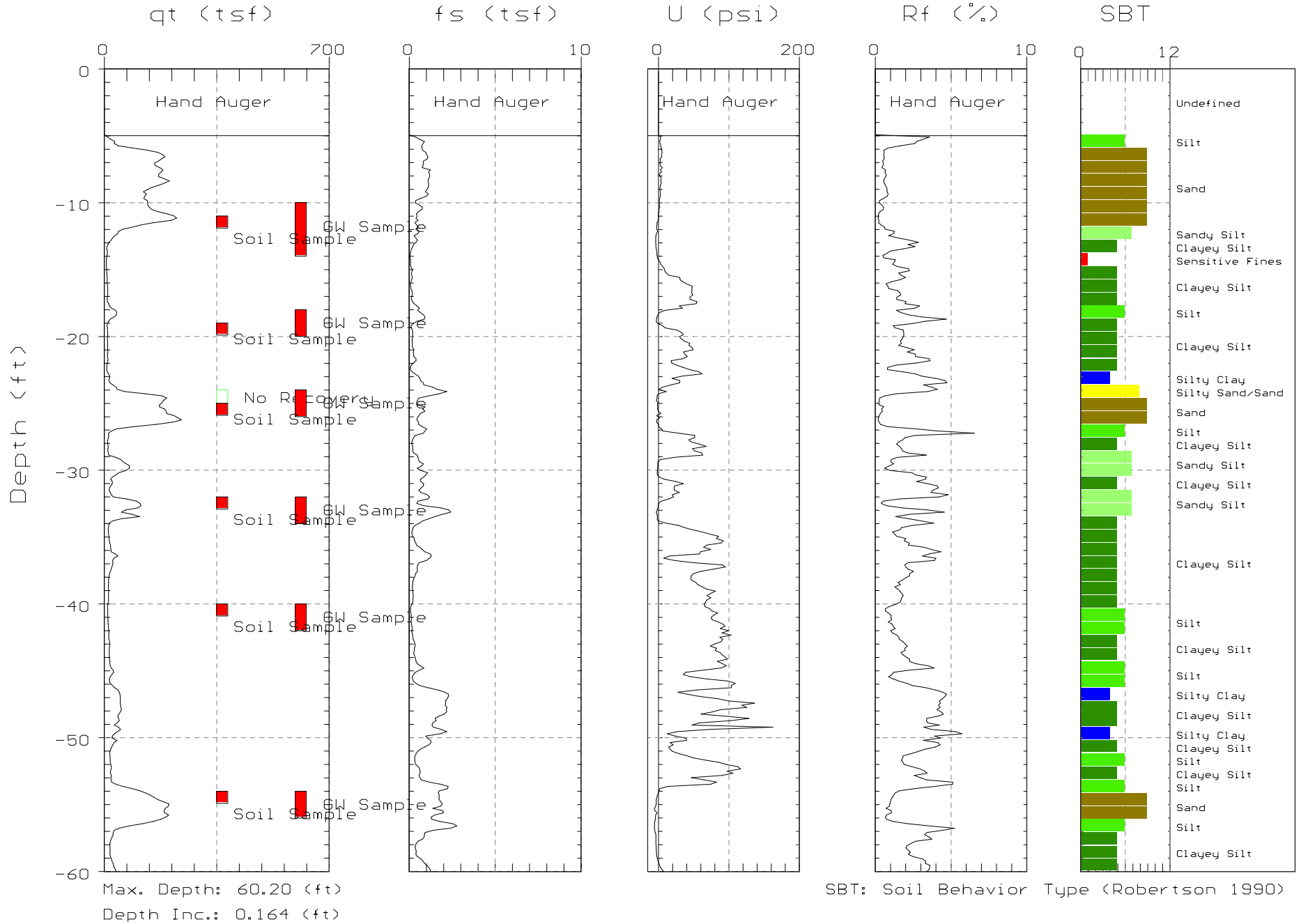



TETRA TECH

Site: WATS OPT BLDG 88
Location: CPT-88-13

Geologist: L.DUDUS
Date: 04:18:05 09:27

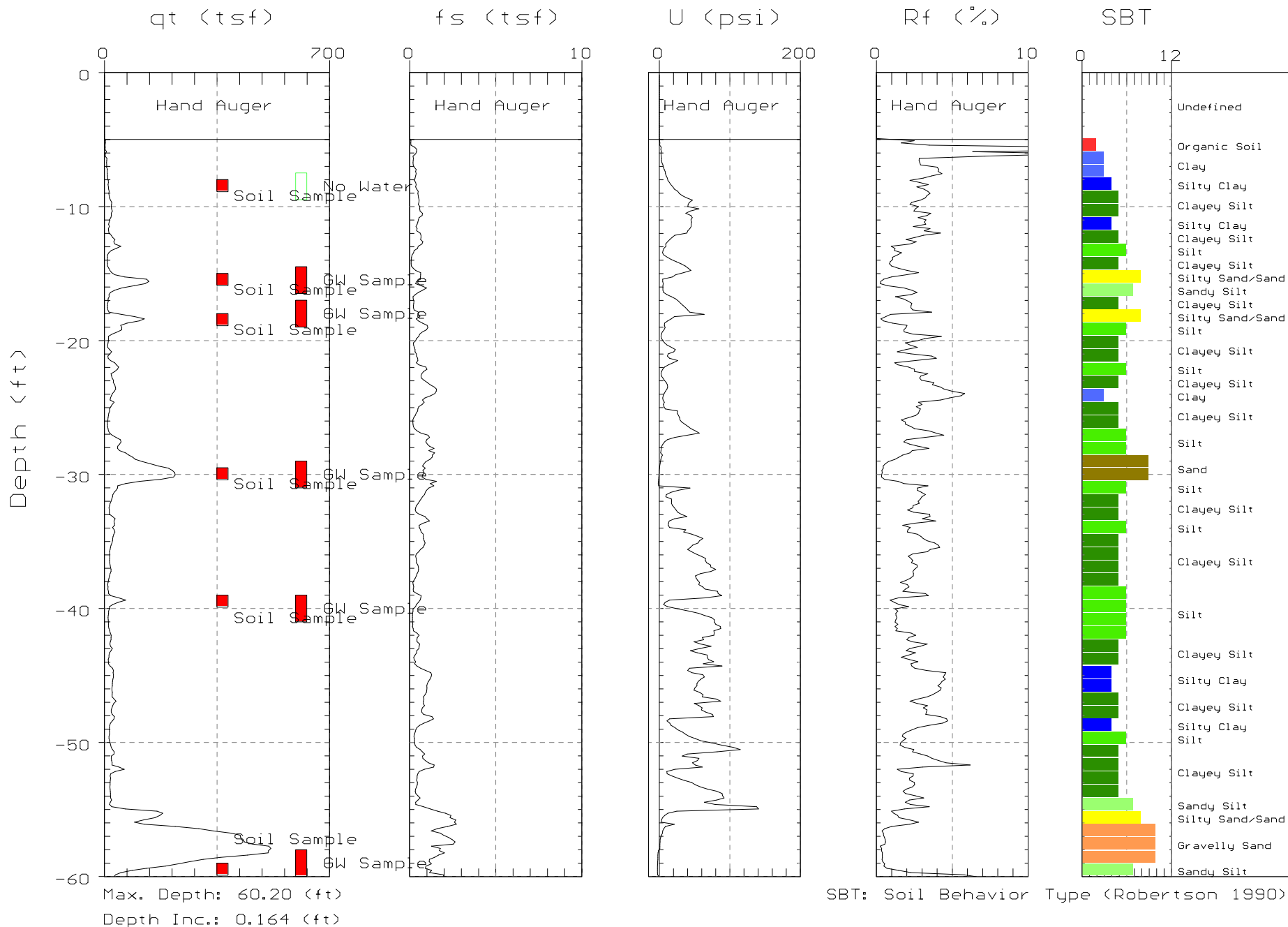



TETRA TECH

Site: WATS OPT BLDG 88
Location: CPT-88-18

Geologist: L.DUDUS
Date: 04:21:05 15:58

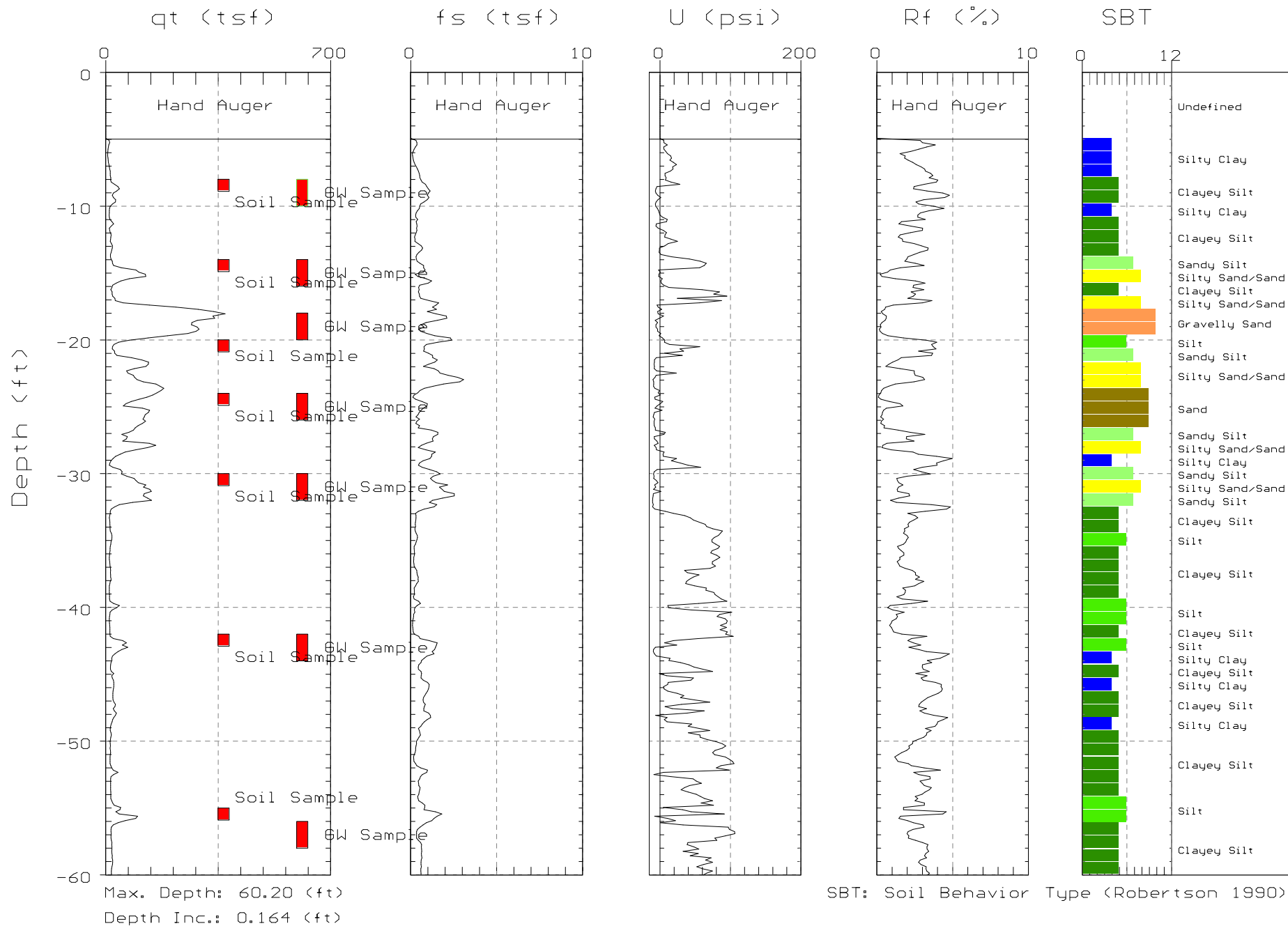



TETRA TECH

Site: WATS OPT BLDG 88
Location: CPT-88-19

Geologist: L.DUDUS
Date: 04:21:05 14:36

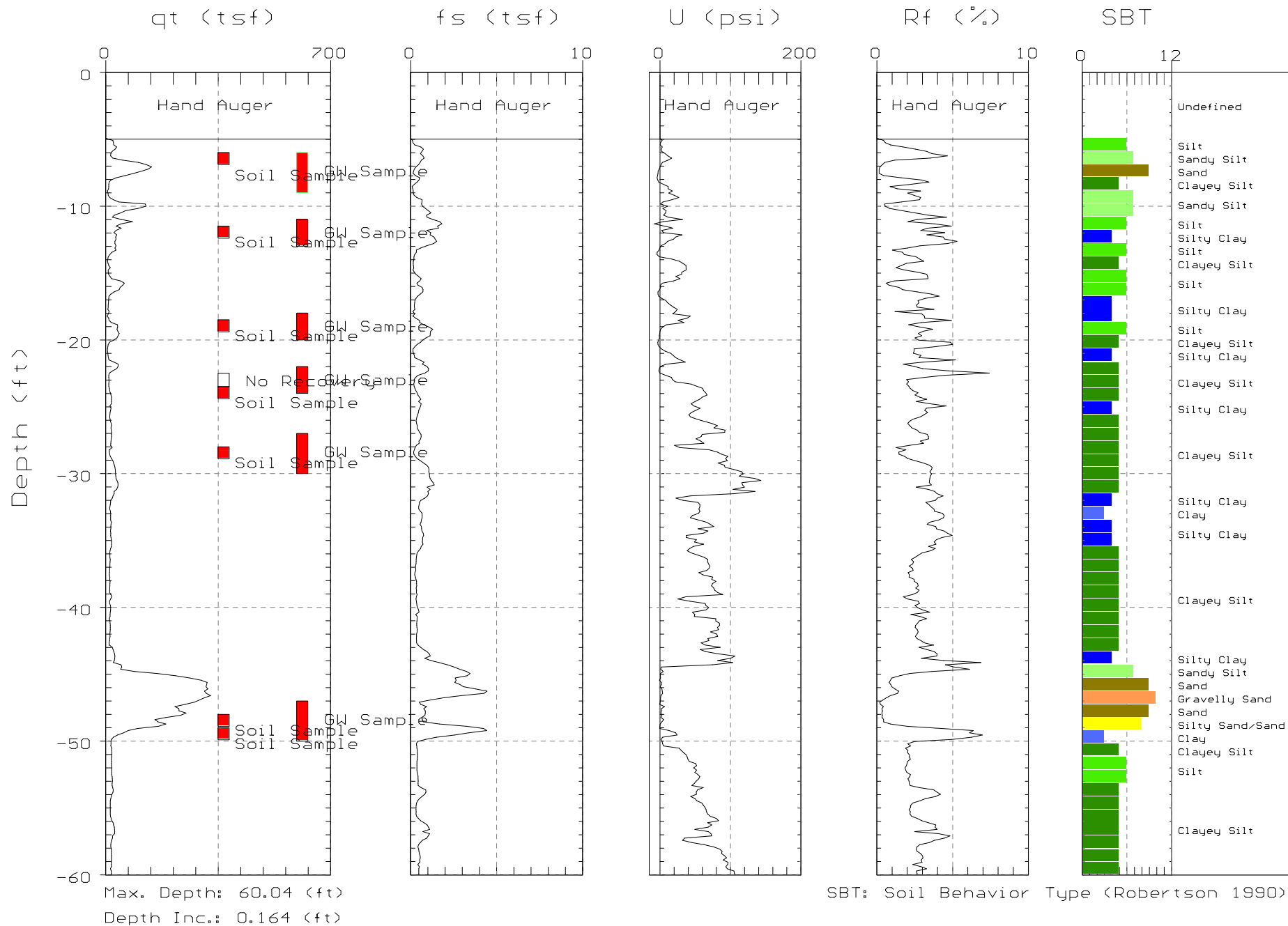



TETRA TECH

Site: MOFFETT FED. AIR FIELD
Location: CPT-88-21

Engineer: L.DUDUS
Date: 05/03/05 10:19

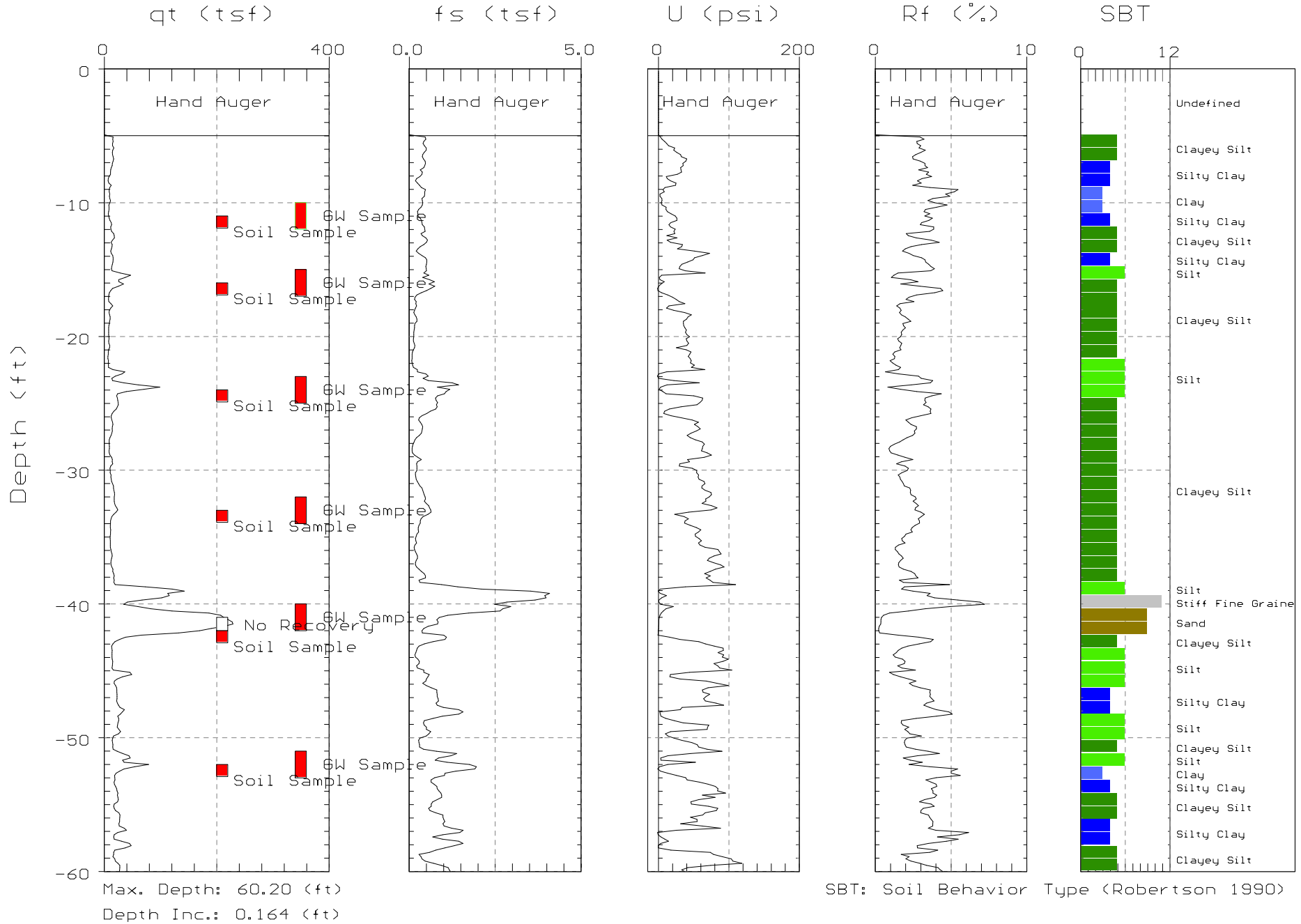



TETRA TECH

Site: WATS OPT BLDG 88
Location: CPT-88-23

Engineer: Larry Dudas
Date: 05/06/05 07:58

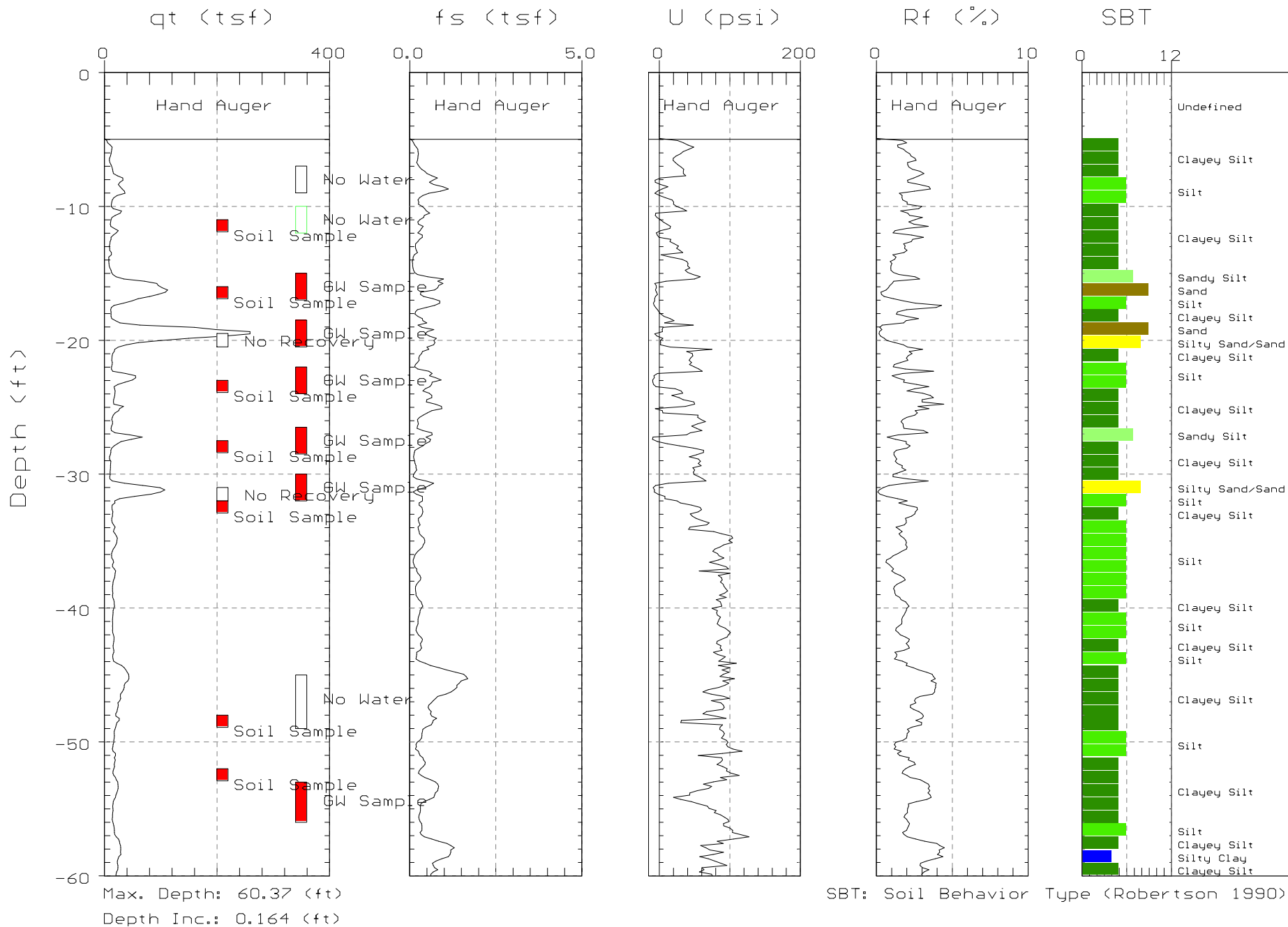

5.G Attachment B: Results of Liquefaction Analysis

TETRA TECH FW, INC.

LOG OF BORING EA2-3 (Sheet 1 of 2)

Client: US NAVY	Drilling Company: West Hazmat
Project: WATS Optimization	Drilling Method: ARCH
Project Number: 1990.071E	Sampling Method: CPT
Location: FORMER NAS MOFFETT FIELD, CA	Borehole Diameter: 16 in. 0-15Ft. 13 in. 15-51Ft.
Geologist: J. Jackson	Northing: 1977155.29 (NAD83)
Date Started: December 4, 2003	Easting: 6110078.67 (NAD83)
Date Completed: December 8, 2003	Ground Surface Elevation: 19.04 AMSL (NAVD88)
Total Depth: 51.0 Feet bgs	Top of Casing Elevation: 16.33 AMSL (NAVD88)

Depth (ft.)	Well/Boring Completion	Well/Boring Remarks	Samples	Sample ID	PID Results	USCS	Graphic Log	LITHOLOGIC DESCRIPTION	Elevation (ft.)
0		5x3x4' Concrete Well Vault flush with ground surface				FI		Backfill Material	19.04
0 - 5		Concrete Surface Seal (2.6 - 5 ft. bgs)				ML		SILT	15
5 - 10		Cement Grout mix of Portland Cement with Wyoming Bentonite (5 - 22 ft. bgs)				CL/ML		SILTY CLAY	10
10 - 15		Static Water Level of 9.79 ft. was Measured on 12/8/03				ML/CL		CLAYEY SILT	10
15 - 20		6-inch 304 Stainless Steel Extraction Well Casing with a 1-inch 304 Stainless Steel Drop Tube and a 1-inch 304 Stainless Steel Piezometer (2.6 - 29 ft. bgs)				CL		CLAY	5
20 - 25		Hydrated 3/8" Bentonite Pellets (22 - 27 ft. bgs)				CL/ML		SILTY CLAY	0
25 - 26						ML		SILT	0
26 - 27						CL		CLAY	-5
27 - 28						ML/CL		CLAYEY SILT	-5
28 - 29						CL/ML		SILTY CLAY	-10
29 - 30						CL		CLAY	-10
30 - 31						ML		SANDY SILT	-10
31 - 32						CL/ML		SILTY CLAY	-10
32 - 33						ML/CL		CLAYEY SILT	-10
33 - 34						CL/ML		SILTY CLAY	-10
34 - 35		Centralizer at 29 ft. bgs				CL/ML		SILTY CLAY	-10

Notes: Reviewed by J. Jackson on 10/25/2004
 bgs = below ground surface
 AMSL = above mean sea level
 NAD 83 = North American Datum 1983
 NAVD 88 = North American Vertical Datum 1988

PID = Photoionization Detector
 PVC = Polyvinyl Chloride (Schedule 40)

TETRA TECH FW, INC.

LOG OF BORING EA2-3 (Sheet 2 of 2)

Client: US NAVY	Drilling Company: West Hazmat
Project: WATS Optimization	Drilling Method: ARCH
Project Number: 1990.071E	Sampling Method: CPT
Location: FORMER NAS MOFFETT FIELD, CA	Borehole Diameter: 16 in. 0-15Ft. 13 in. 15-51Ft.
Geologist: J. Jackson	Northing: 1977155.29 (NAD83)
Date Started: December 4, 2003	Easting: 6110078.67 (NAD83)
Date Completed: December 8, 2003	Ground Surface Elevation: 19.04 AMSL (NAVD88)
Total Depth: 51.0 Feet bgs	Top of Casing Elevation: 16.33 AMSL (NAVD88)

Depth (ft.)	Well/Boring Completion	Well/Boring Remarks	Samples	Sample ID	PID Results	USCS	Graphic Log	LITHOLOGIC DESCRIPTION	Elevation (ft.)
35		#2/16 Sand Filter Pack (27 - 51 ft. bgs)				SP		SAND	
						SW		GRAVELLY SAND	
						SM		SILTY SAND	-15
		6-inch (0.010 Slot) Wire-Wrap 304 Stainless Steel Screen with two 1-inch (0.010 Slot) 304 Stainless Steel Screens (29 - 49 ft. bgs)				CL/ML		SILTY CLAY	
40						ML/CL		CLAYEY SILT	
						CL/ML		SILTY CLAY	-20
						ML/CL		CLAYEY SILT	
45						ML		SILT	-25
						ML/CL		CLAYEY SILT	
						CL/ML		SILTY CLAY	
						ML/CL		CLAYEY SILT	
50		Centralizer at 49 ft. bgs Silt Traps (1' silt trap for extraction well and 2" silt trap for piezometer and drop tube)				CL		CLAY	-30
						CL/ML		SILTY CLAY	
55									-35
									-40

210620 SVE MULTI-COMPLETION W/SS_CTO 71 WATS OPTIMIZATION.GPJ_FSTRW_SA.GDT 2/15/05

Notes: Reviewed by J. Jackson on 10/25/2004
 bgs = below ground surface
 AMSL = above mean sea level
 NAD 83 = North American Datum 1983
 NAVD 88 = North American Vertical Datum 1988

PID = Photoionization Detector
 PVC = Polyvinyl Chloride (Schedule 40)

TETRA TECH EC, INC.

LOG OF BORING W88-1 (Sheet 1 of 4)

Client: US NAVY	Drilling Company: Prosonic
Project: WATS OPT ADDENDUM - BUILDING 88	Drilling Method: Sonic
Project Number: 1990.086E	Sampling Method: continuous core
Location: FORMER NAS MOFFETT FIELD, CA	Borehole Diameter: 9 in.0-57 Ft. 8 in.57-97 Ft.
Geologist: L.Dudus	Northing: 1,975,922.00 Feet (NAD 83; NAVD 88)
Date Started: July 26, 2005	Easting: 6,110,435.60 Feet (NAD 83; NAVD 88)
Date Completed: July 28, 2005	Ground Surface Elevation: 20.40 Feet amsl
Total Depth: 97.0 Feet bgs	Top of Casing Elevation: 19.93 Feet amsl

Depth (ft.)	Water Level	Well/Boring Completion	Well/Boring Remarks	PID Readings PPM	USCS	Graphic Log	LITHOLOGIC DESCRIPTION	Elevation (ft.)
0			12" Morrison flushmount with 3/4" bolts set in 2' round concrete pad. ← Concrete				0 to 57 ft. Not logged. Please see CPT-88-13 log for lithology. W88-1 was installed by overdrilling the CPT-88-13 boring.	20
5								15
10								10
15								5
20			← 4" diameter 304 Stainless Steel Blank Casing					0

Notes: Boring Log Reviewed By: D. Goldman 8/29/05
 bgs = below ground surface
 AMSL = above mean sea level
 NA = not applicable

TETRA TECH EC, INC.

LOG OF BORING W88-1 (Sheet 2 of 4)

Client: US NAVY	Drilling Company: Prosonic
Project: WATS OPT ADDENDUM - BUILDING 88	Drilling Method: Sonic
Project Number: 1990.086E	Sampling Method: continuous core
Location: FORMER NAS MOFFETT FIELD, CA	Borehole Diameter: 9 in.0-57 Ft. 8 in.57-97 Ft.
Geologist: L.Dudus	Northing: 1,975,922.00 Feet (NAD 83; NAVD 88)
Date Started: July 26, 2005	Easting: 6,110,435.60 Feet (NAD 83; NAVD 88)
Date Completed: July 28, 2005	Ground Surface Elevation: 20.40 Feet amsl
Total Depth: 97.0 Feet bgs	Top of Casing Elevation: 19.93 Feet amsl

Depth (ft.)	Water Level	Well/Boring Completion	Well/Boring Remarks	PID Readings PPM	USCS	Graphic Log	LITHOLOGIC DESCRIPTION	Elevation (ft.)
30								-5
35			← Grout (95% cement 5% bentonite)					-10
40								-15
45								-20
								-25

Notes: Boring Log Reviewed By: D. Goldman 8/29/05
 bgs = below ground surface
 AMSL = above mean sea level
 NA = not applicable

TETRA TECH EC, INC.

LOG OF BORING W88-1 (Sheet 3 of 4)

Client: US NAVY	Drilling Company: Prosonic
Project: WATS OPT ADDENDUM - BUILDING 88	Drilling Method: Sonic
Project Number: 1990.086E	Sampling Method: continuous core
Location: FORMER NAS MOFFETT FIELD, CA	Borehole Diameter: 9 in.0-57 Ft. 8 in.57-97 Ft.
Geologist: L.Dudus	Northing: 1,975,922.00 Feet (NAD 83; NAVD 88)
Date Started: July 26, 2005	Easting: 6,110,435.60 Feet (NAD 83; NAVD 88)
Date Completed: July 28, 2005	Ground Surface Elevation: 20.40 Feet amsl
Total Depth: 97.0 Feet bgs	Top of Casing Elevation: 19.93 Feet amsl

Depth (ft.)	Water Level	Well/Boring Completion	Well/Boring Remarks	PID Readings PPM	USCS	Graphic Log	LITHOLOGIC DESCRIPTION	Elevation (ft.)
55								-30
60					ML		57 to 60 ft. SILT WITH SAND: light olive brown (2.5Y 5/3), moist, 85% fines with medium plasticity, 15% fine to medium subrounded sand.	-35
65					SM		60 to 62 ft. SILTY SAND: light olive brown (2.5Y 5/3), wet, 80% fine to medium subrounded sand, 20% non-plastic fines.	-40
					ML		62 to 65 ft. SANDY SILT: grayish brown (2.5Y 5/2), wet, 60% fines with low to medium plasticity, 40% fine to medium subrounded sand, trace gravel.	-45
					CL		65 to 67 ft. CLAY: grayish brown (2.5Y 5/2), moist, 90% fines with high plasticity, 10% fine sand.	-45
					ML		67 to 68.5 ft. SANDY SILT: dark gray (2.5Y N/4), wet, 70% fines with low to medium plasticity, 30% fine sand.	-50
					CL		68.5 to 71 ft. CLAY: grayish brown (2.5Y 5/2), moist, 90% fines with high plasticity, 10% fine sand.	-50
					SW-SM		71 to 74.5 ft. WELL GRADED SAND WITH SILT AND GRAVEL: grayish brown (2.5Y 5/2), wet, 70% fine to coarse subrounded to subangular sand, 20% fine subangular gravel, 10% non-plastic fines.	
					ML			

← Bentonite Seal (Enviroplug medium)

 ← Filter Pack (#2/16 Sand)

 ← Centralizer

Notes: Boring Log Reviewed By: D. Goldman 8/29/05
 bgs = below ground surface
 AMSL = above mean sea level
 NA = not applicable

TETRA TECH EC, INC.

LOG OF BORING W88-1 (Sheet 4 of 4)

Client: US NAVY	Drilling Company: Prosonic
Project: WATS OPT ADDENDUM - BUILDING 88	Drilling Method: Sonic
Project Number: 1990.086E	Sampling Method: continuous core
Location: FORMER NAS MOFFETT FIELD, CA	Borehole Diameter: 9 in.0-57 Ft. 8 in.57-97 Ft.
Geologist: L.Dudus	Northing: 1,975,922.00 Feet (NAD 83; NAVD 88)
Date Started: July 26, 2005	Easting: 6,110,435.60 Feet (NAD 83; NAVD 88)
Date Completed: July 28, 2005	Ground Surface Elevation: 20.40 Feet amsl
Total Depth: 97.0 Feet bgs	Top of Casing Elevation: 19.93 Feet amsl

Depth (ft.)	Water Level	Well/Boring Completion	Well/Boring Remarks	PID Readings PPM	USCS	Graphic Log	LITHOLOGIC DESCRIPTION	Elevation (ft.)
80			4" diameter .010" 304 Stainless Steel Wire-Wrapped Screen		SM		74.5 to 75 ft. SILT: grayish brown (2.5Y 5/2), moist, 90% fines with medium plasticity, 10% fine sand.	-55
			Centralizer		ML		75 to 75.5 ft. SILTY SAND: grayish brown (2.5Y 5/2), wet, 80% fine to coarse subrounded sand, 20% non-plastic fines. 75.5 to 79.5 ft. SILT: grayish brown (2.5Y 5/2), moist, 90% fines with medium plasticity, 10% fine to coarse subrounded sand.	
					CL-ML		79.5 to 85 ft. CLAY AND SILT: grayish brown (2.5Y 5/2), moist, 90% fines with medium to high plasticity, 10% fine sand.	-60
			Bentonite Backfill (Enviroplug medium)		ML		85 to 87 ft. SILT WITH SAND: grayish brown (2.5Y 5/2), moist, 85% fines with medium plasticity, 15% fine to coarse subrounded sand.	-65
					SM		87 to 90 ft. SILTY SAND: dark grayish brown (2.5Y 4/2), wet, 70% fine sand, 30% fines with low plasticity.	
					ML		90 to 95 ft. SILT: dark grayish brown (2.5Y 4/2), moist, 90% fines with medium plasticity, 10% fine sand.	-70
					CL		95 to 97 ft. CLAY: dark grayish brown (2.5Y 4/2), moist, 90% fines with high plasticity, 10% fine sand.	-75
							Total depth = 97 feet bgs.	

Notes: Boring Log Reviewed By: D. Goldman 8/29/05
 bgs = below ground surface
 AMSL = above mean sea level
 NA = not applicable

TTFW WELL CONSTRUCTION BUILDING 88.GPJ FSTRW_SA.GDT 8/30/05

TETRA TECH EC, INC.

LOG OF BORING W88-2 (Sheet 1 of 4)

Client: US NAVY	Drilling Company: Prosonic
Project: WATS OPT ADDENDUM - BUILDING 88	Drilling Method: Sonic
Project Number: 1990.086E	Sampling Method: continuous core
Location: FORMER NAS MOFFETT FIELD, CA	Borehole Diameter: 9 in.0-62.5 Ft. 8 in.62.5-97 Ft.
Geologist: B. Bartelma	Northing: 1,977,212.20 Feet (NAD 83; NAVD 88)
Date Started: July 29, 2005	Easting: 6,110,253.80 Feet (NAD 83; NAVD 88)
Date Completed: August 1, 2005	Ground Surface Elevation: 18.80 Feet amsl
Total Depth: 97.0 Feet bgs	Top of Casing Elevation: 18.17 Feet amsl

Depth (ft.)	Water Level	Well/Boring Completion	Well/Boring Remarks	PID Readings PPM	USCS	Graphic Log	LITHOLOGIC DESCRIPTION	Elevation (ft.)
5			12" Morrison flushmount with 3/4" bolts set in 2' round concrete pad. ← Concrete				Not logged. Please see WO-CPT2 for lithology. W88-2 was installed by overdrilling the WO-CPT2 boring.	15
10								10
15								5
20								0
			← 4" diameter 304 Stainless Steel Blank Casing					-5

Notes: Boring Log Reviewed By: D. Goldman 8/29/05
 bgs = below ground surface
 AMSL = above mean sea level
 NA = not applicable

TETRA TECH EC, INC.

LOG OF BORING W88-2 (Sheet 2 of 4)

Client: US NAVY	Drilling Company: Prosonic
Project: WATS OPT ADDENDUM - BUILDING 88	Drilling Method: Sonic
Project Number: 1990.086E	Sampling Method: continuous core
Location: FORMER NAS MOFFETT FIELD, CA	Borehole Diameter: 9 in.0-62.5 Ft. 8 in.62.5-97 Ft.
Geologist: B. Bartelma	Northing: 1,977,212.20 Feet (NAD 83; NAVD 88)
Date Started: July 29, 2005	Easting: 6,110,253.80 Feet (NAD 83; NAVD 88)
Date Completed: August 1, 2005	Ground Surface Elevation: 18.80 Feet amsl
Total Depth: 97.0 Feet bgs	Top of Casing Elevation: 18.17 Feet amsl

Depth (ft.)	Water Level	Well/Boring Completion	Well/Boring Remarks	PID Readings PPM	USCS	Graphic Log	LITHOLOGIC DESCRIPTION	Elevation (ft.)
30			← Centralizer					-10
35			← Grout (95% cement 5% bentonite)					-15
40								-20
45								-25
								-30

Notes: Boring Log Reviewed By: D. Goldman 8/29/05
 bgs = below ground surface
 AMSL = above mean sea level
 NA = not applicable

TETRA TECH EC, INC.

LOG OF BORING W88-2 (Sheet 3 of 4)

Client: US NAVY	Drilling Company: Prosonic
Project: WATS OPT ADDENDUM - BUILDING 88	Drilling Method: Sonic
Project Number: 1990.086E	Sampling Method: continuous core
Location: FORMER NAS MOFFETT FIELD, CA	Borehole Diameter: 9 in.0-62.5 Ft. 8 in.62.5-97 Ft.
Geologist: B. Bartelma	Northing: 1,977,212.20 Feet (NAD 83; NAVD 88)
Date Started: July 29, 2005	Easting: 6,110,253.80 Feet (NAD 83; NAVD 88)
Date Completed: August 1, 2005	Ground Surface Elevation: 18.80 Feet amsl
Total Depth: 97.0 Feet bgs	Top of Casing Elevation: 18.17 Feet amsl

Depth (ft.)	Water Level	Well/Boring Completion	Well/Boring Remarks	PID Readings PPM	USCS	Graphic Log	LITHOLOGIC DESCRIPTION	Elevation (ft.)
55								-35
60								-40
62.5					CL-ML		62.5 to 63.5 ft. CLAY AND SILT: olive brown (2.5Y 4/3), moist, 90% fines with moderate to high plasticity, 10% fine sand.	-45
63.5					ML		63.5 to 64.5 ft. SANDY SILT: olive brown (2.5Y 4/3), moist, 60% fines with low plasticity, 40% fine sand.	-45
64.5					CL		64.5 to 66 ft. CLAY: olive brown (2.5Y 4/3), moist, 90% fines with high plasticity, 10% fine sand.	-45
66					ML		66 to 67 ft. SANDY SILT: dark grayish brown (2.5Y 4/2), moist, 60% fines with low plasticity, 40% fine sand.	-45
67					CL-ML		67 to 69 ft. CLAY AND SILT: dark gray (5Y 4N), moist, 90% fines with medium to high plasticity, 10% fine sand.	-50
69					ML		69 to 70 ft. SANDY SILT: dark grayish brown (2.5Y 4/2), moist, 60% fines with low plasticity, 40% fine sand.	-50
70					CL		70 to 77 ft. CLAY: olive gray (5Y 4/2), moist, 90% fines with high plasticity, 10% fine sand.	-55
			← Bentonite Seal (Enviroplug medium)					

Notes: Boring Log Reviewed By: D. Goldman 8/29/05
 bgs = below ground surface
 AMSL = above mean sea level
 NA = not applicable

TETRA TECH EC, INC.

LOG OF BORING W88-2 (Sheet 4 of 4)

Client: US NAVY	Drilling Company: Prosonic
Project: WATS OPT ADDENDUM - BUILDING 88	Drilling Method: Sonic
Project Number: 1990.086E	Sampling Method: continuous core
Location: FORMER NAS MOFFETT FIELD, CA	Borehole Diameter: 9 in.0-62.5 Ft. 8 in.62.5-97 Ft.
Geologist: B. Bartelma	Northing: 1,977,212.20 Feet (NAD 83; NAVD 88)
Date Started: July 29, 2005	Easting: 6,110,253.80 Feet (NAD 83; NAVD 88)
Date Completed: August 1, 2005	Ground Surface Elevation: 18.80 Feet amsl
Total Depth: 97.0 Feet bgs	Top of Casing Elevation: 18.17 Feet amsl

Depth (ft.)	Water Level	Well/Boring Completion	Well/Boring Remarks	PID Readings PPM	USCS	Graphic Log	LITHOLOGIC DESCRIPTION	Elevation (ft.)
			← Filter Pack (#2/16 Sand)		CL			
			← Centralizer		SP-SM		77 to 79.5 ft. POORLY GRADED SAND WITH SILT: olive (5Y 4/3), wet, 90% fine to medium sand, 10% non-plastic fines.	-60
80					ML		79.5 to 80 ft. CLAYEY SILT WITH SAND: olive gray (5Y 4/2), moist, 80% fines with medium to high plasticity, 20% fine sand.	
					SM			
					ML		80 to 80.5 ft. SILTY SAND: olive (5Y 4/3), wet, 80% fine to medium sand, 20% non-plastic fines.	
			← 4" diameter .010" 304 Stainless Steel Wire-Wrapped Screen		CL		80.5 to 82 ft. CLAYEY SILT WITH SAND: olive gray (5Y 4/2), moist, 80% fines with medium to high plasticity, 20% fine sand.	-65
			← Centralizer		ML		82 to 84.5 ft. CLAY: olive gray (5Y 4/2), moist, 90% fines with high plasticity, 10% fine sand.	
85					ML		84.5 to 85.5 ft. SILT WITH SAND: olive gray (5Y 4/2), moist, 80% fines with medium plasticity, 20% fine sand.	
					SM		85.5 to 86 ft. SILTY SAND: olive gray (5Y 4/2), wet, 80% fine to coarse sand, 20% non-plastic fines, trace fine gravel.	
					ML		86 to 87 ft. SANDY SILT: olive gray (5Y 4/2), wet, 60% fines with low plasticity, 40% fine sand.	
					ML		87 to 90 ft. CLAYEY SILT WITH SAND: olive gray (5Y 4/2), moist, 80% fines with medium to high plasticity, 20% fine sand.	-70
90					ML		90 to 93 ft. SANDY SILT: olive gray (5Y 4/2), wet, 60% fines with low plasticity, 40% fine sand.	
					ML			
			← Bentonite Backfill (Enviroplug medium)		CL-ML		93 to 97 ft. CLAY AND SILT: olive gray (5Y 4/2), moist, 85% fines with high plasticity, 15% fine sand.	-75
95								
							TD = 97 feet bgs.	-80

Notes: Boring Log Reviewed By: D. Goldman 8/29/05
 bgs = below ground surface
 AMSL = above mean sea level
 NA = not applicable

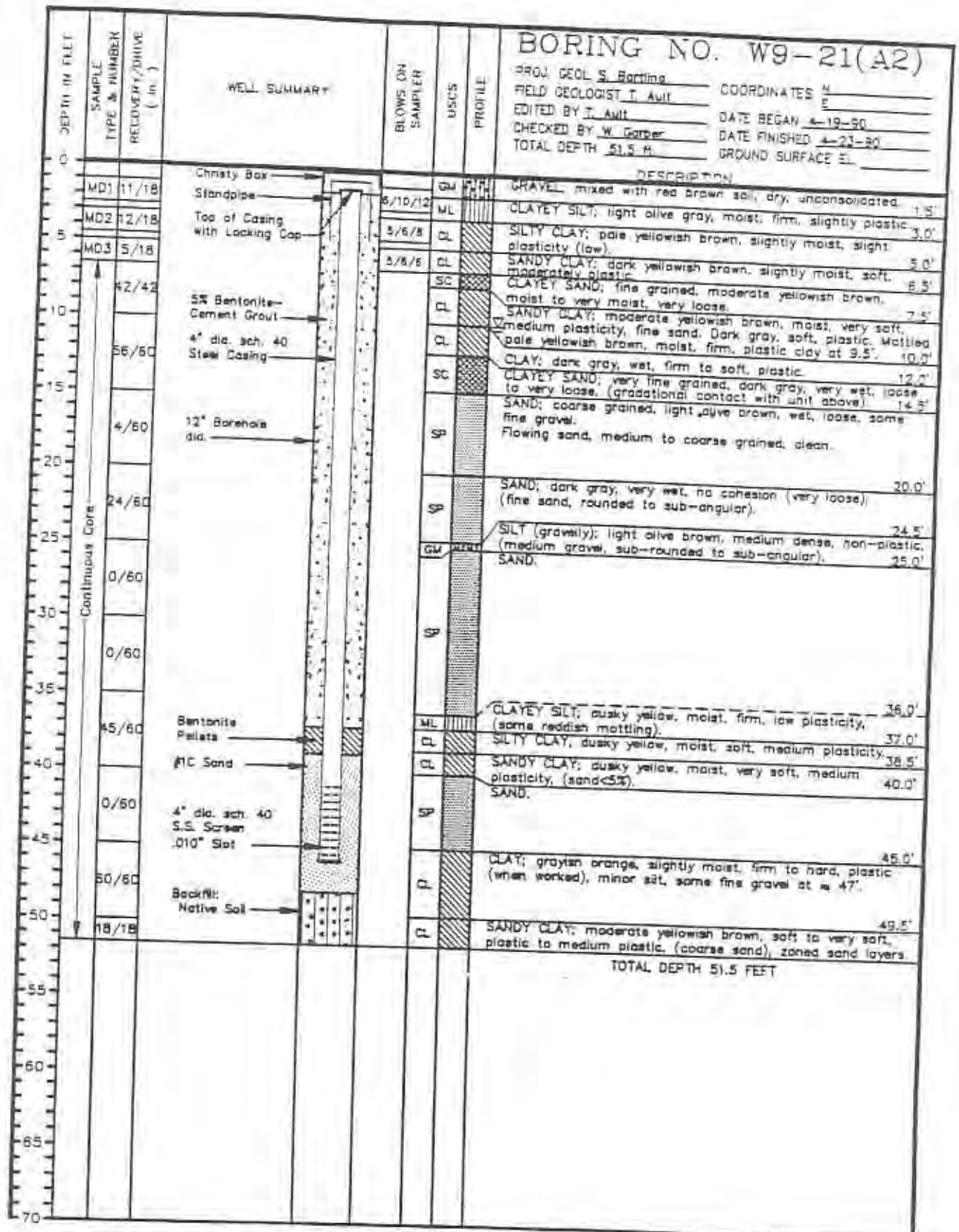

DRILLING CO.: Water Development
 DRILL METHOD: Hollow Stem Auger (Rig CME-75)

PROJECT NO.: 409700
 CLIENT: Moffett Naval Air Station
 LOCATION: Moffett Field, California

SEE LEGEND FOR LOGS AND TEST PITS
 FOR EXPLANATION OF SYMBOLS AND TERMS

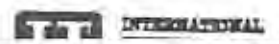

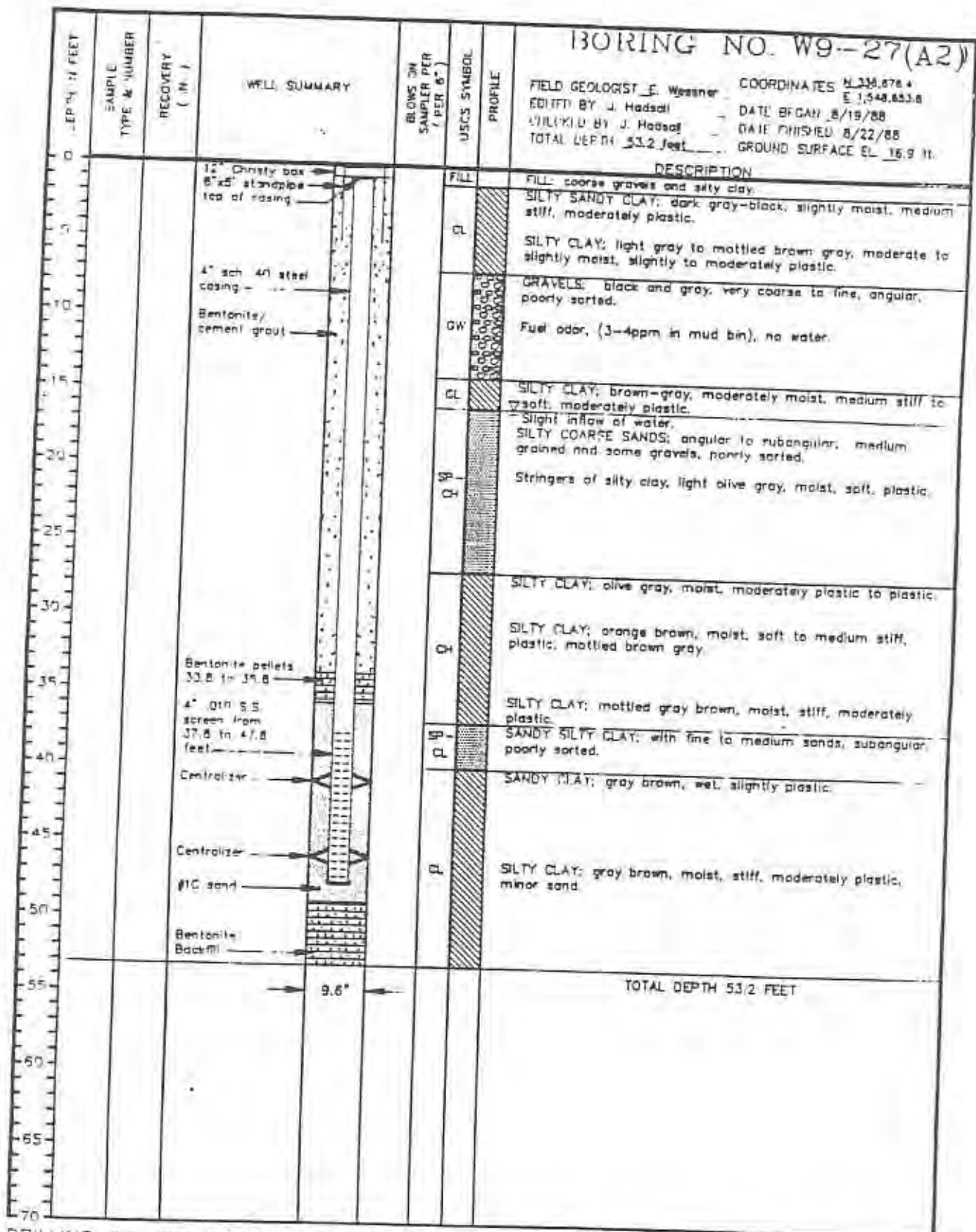

BORING NO. W9-27(A2)

FIELD GEOLOGIST E. Weasner COORDINATES N. 338,878.4
 E 1,548,853.8
 EDITED BY J. Haddad DATE BEGAN 8/19/88
 UTILIZED BY J. Haddad DATE FINISHED 8/22/88
 TOTAL DEPTH 53.2 feet GROUND SURFACE EL. 16.9 ft.

DESCRIPTION

FILL coarse gravel and silty clay.
CL SILTY SANDY CLAY: dark gray-black, slightly moist, medium stiff, moderately plastic.
CL SILTY CLAY: light gray to mottled brown gray, moderate to slightly moist, slightly to moderately plastic.
GW GRAVELS: black and gray, very coarse to fine, angular, poorly sorted.
 Fuel odor, (3-4ppm in mud bin), no water.
CL SILTY CLAY: brown-gray, moderately moist, medium stiff to soft, moderately plastic.
 Slight inflow of water.
SP SILTY COARSE SANDS: angular to subangular, medium grained and some gravels, poorly sorted.
CL Stringers of silty clay, light olive gray, moist, soft, plastic.
CH SILTY CLAY: olive gray, moist, moderately plastic to plastic.
CH SILTY CLAY: orange brown, moist, soft to medium stiff, plastic; mottled brown gray.
SP SILTY CLAY: mottled gray brown, moist, stiff, moderately plastic.
CL SANDY SILTY CLAY: with fine to medium sands, subangular, poorly sorted.
CL SANDY CLAY: gray brown, wet, slightly plastic.
CL SILTY CLAY: gray brown, moist, stiff, moderately plastic, minor sand.

TOTAL DEPTH 53.2 FEET

DRILLING CO.: Water Development Co.
 DRILLING METHOD: Air Rotary

NOTE Redrill of W9-27(B1), (7-19-88)
 No samples taken while drilling this well. Samples taken during the drilling of the original W9-27(B1-abandoned) will be used as sample data.

PROJECT NO.: 409616
 CLIENT: Moffett Naval Air Station
 Moffett Field, California

AMENDED FILE W9-27(B1)DW



...Creating a Safer Tomorrow

SEE LEGEND FOR LOGS AND TEST PITS FOR EXPLANATION OF SYMBOLS AND TERMS

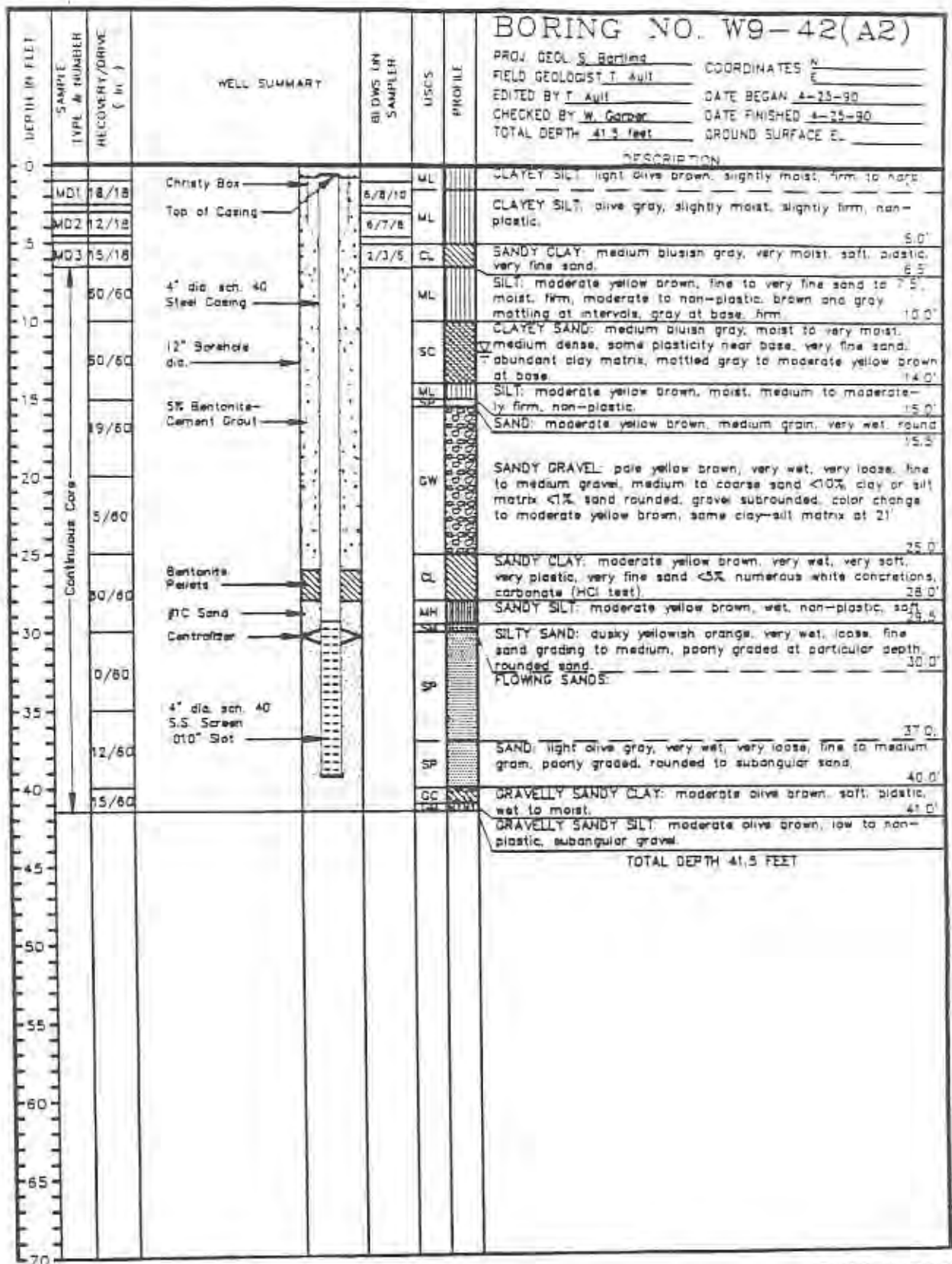

DRILLING CO.: Water Development
 DRILL METHOD: Hollow Stem Auger (Rig CME-75)

PAGE 1 OF 1

PROJECT NO.: 409700
 CLIENT: Moffett Naval Air Station
 LOCATION: Moffett Field, California

SEE LEGEND FOR LOGS AND TEST PITS
 FOR EXPLANATION OF SYMBOLS AND TERMS

LIQUEFACTION ANALYSIS

NASA Hangar 1

Hole No.=CPT-88-7 Water Depth=4 ft Surface Elev.=21

Magnitude=7.9
Acceleration=0.6g

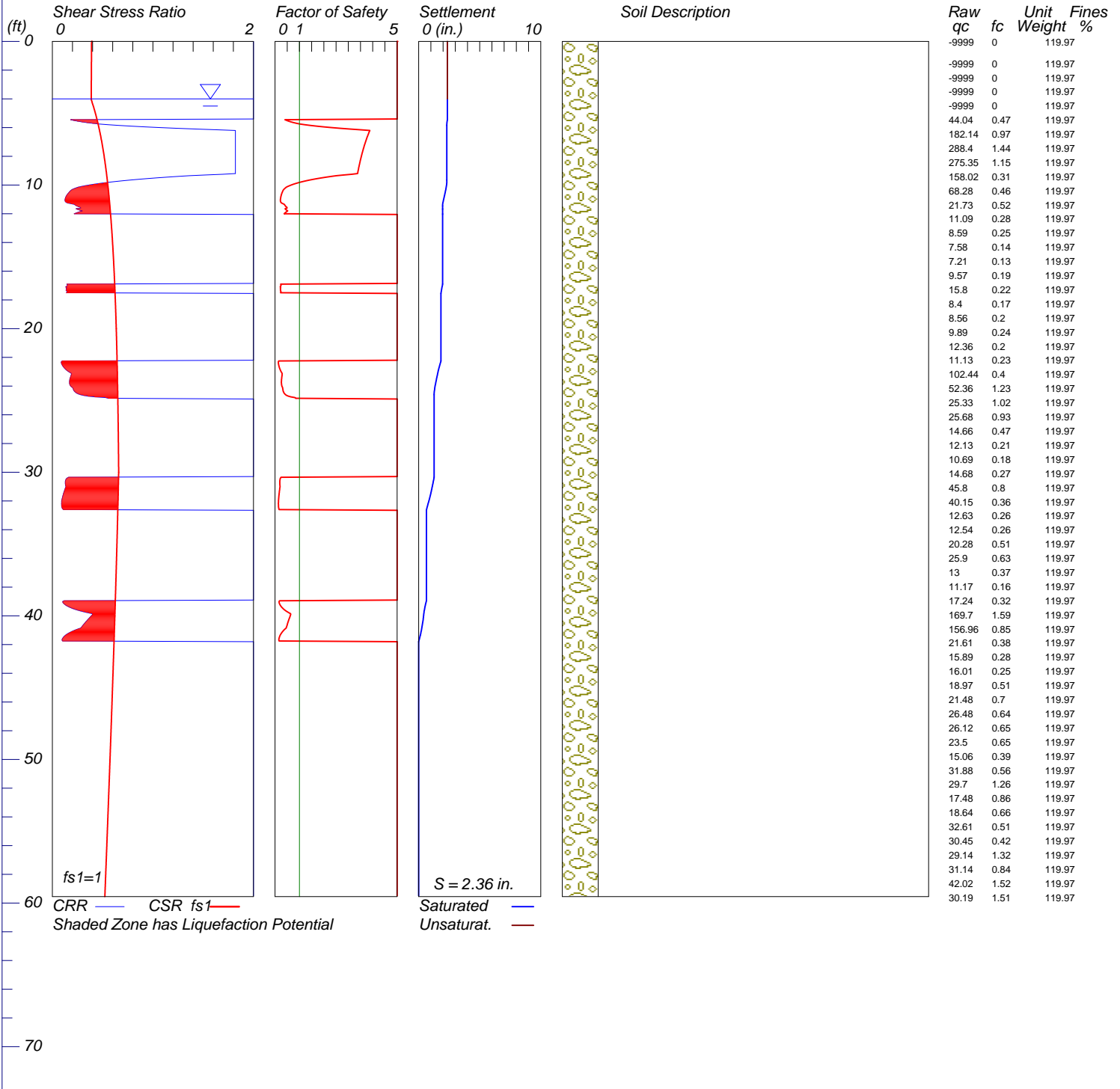

LiquefyPro CivilTech Software USA www.civiltech.com

LIQUEFACTION ANALYSIS

NASA Hangar 1

Hole No.=CPT-88-8 Water Depth=4 ft Surface Elev.=21

Magnitude=7.9
Acceleration=0.6g

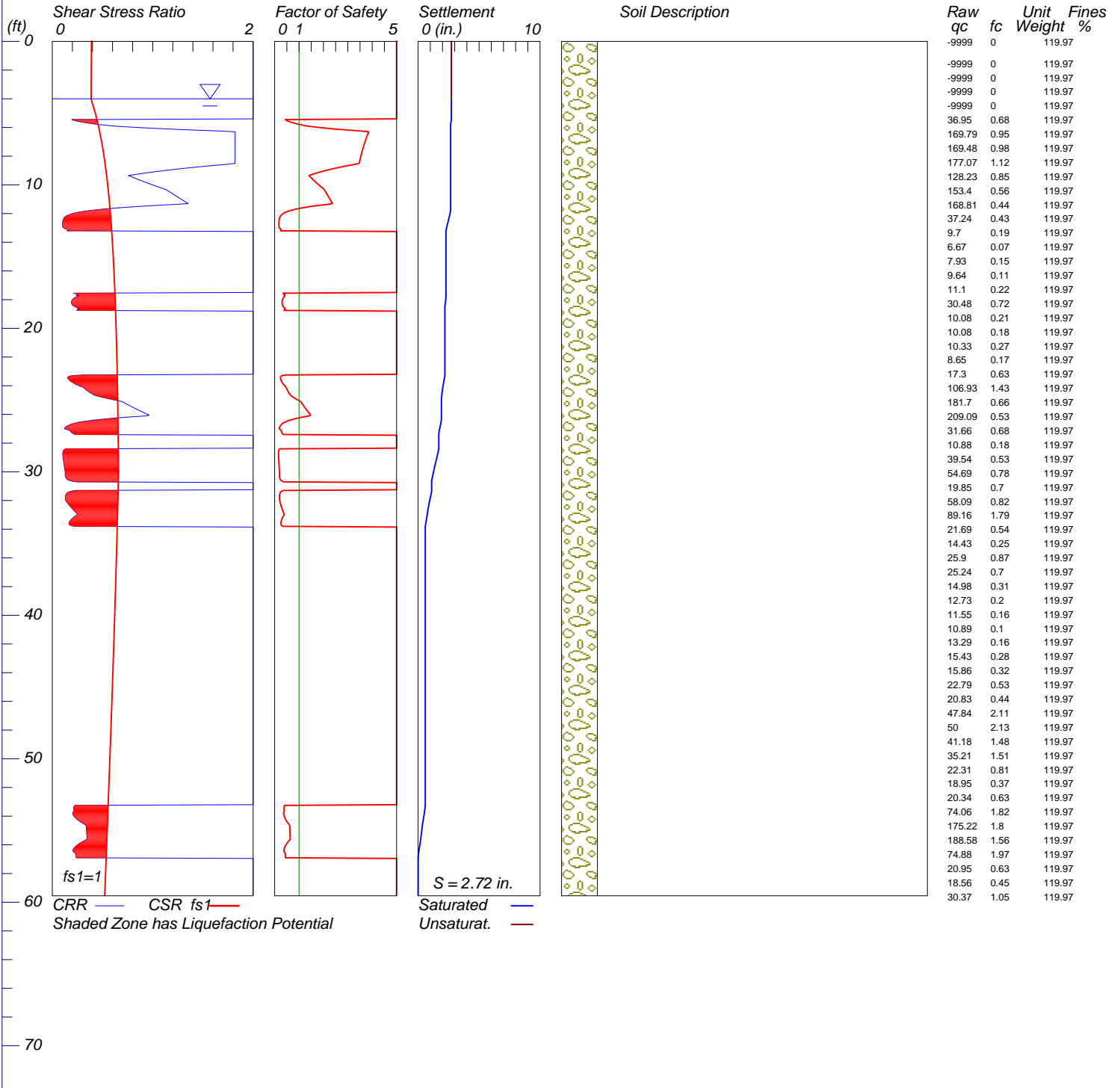

LiquefyPro CivilTech Software USA www.civiltech.com

LIQUEFACTION ANALYSIS

NASA Hangar 1

Hole No.=CPT-88-13 Water Depth=4 ft Surface Elev.=21

Magnitude=7.9
Acceleration=0.6g

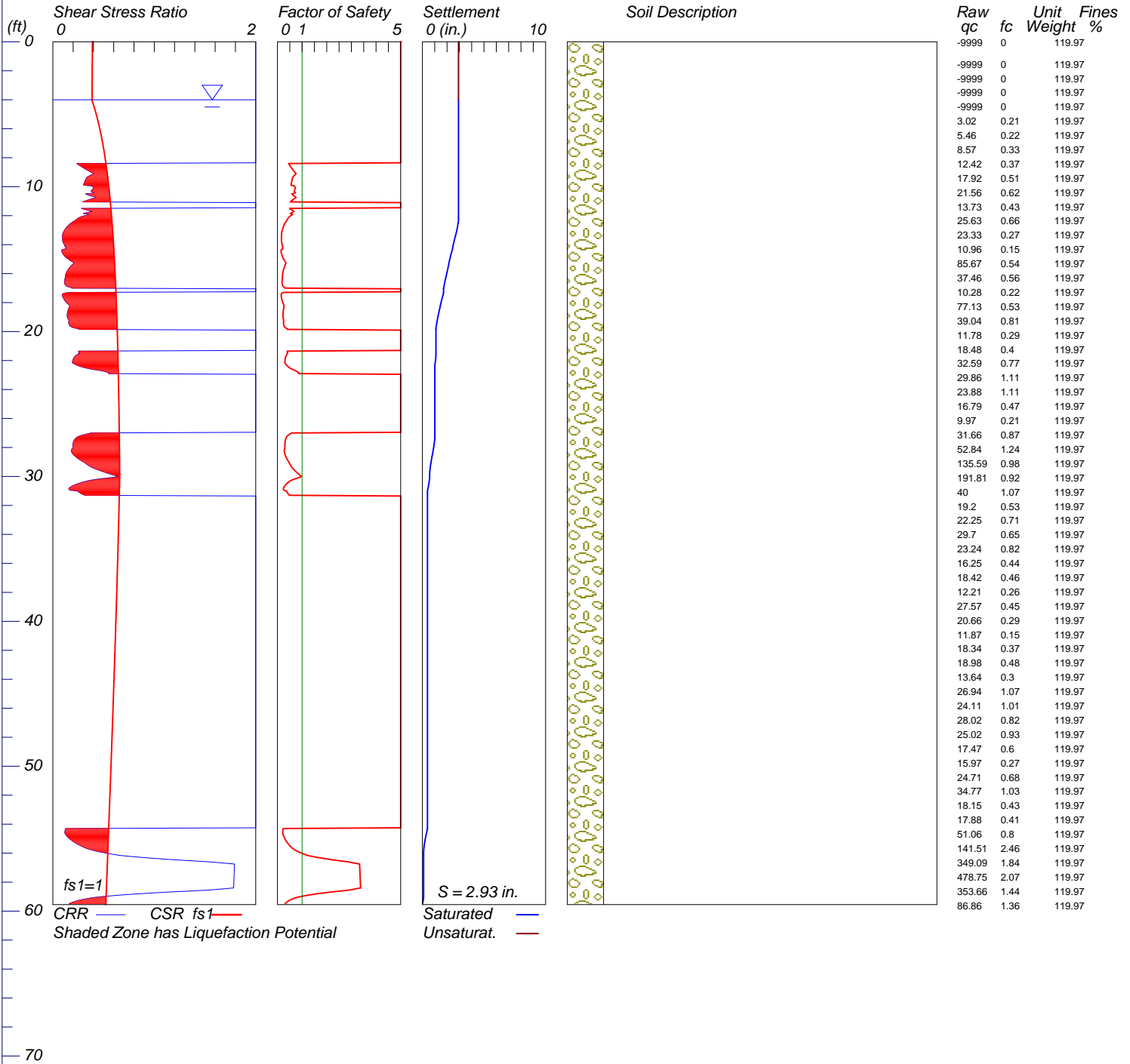

LIQUEFACTION ANALYSIS

NASA Hangar 1

Hole No.=CPT-88-18 Water Depth=4 ft Surface Elev.=21

Magnitude=7.9
Acceleration=0.6g

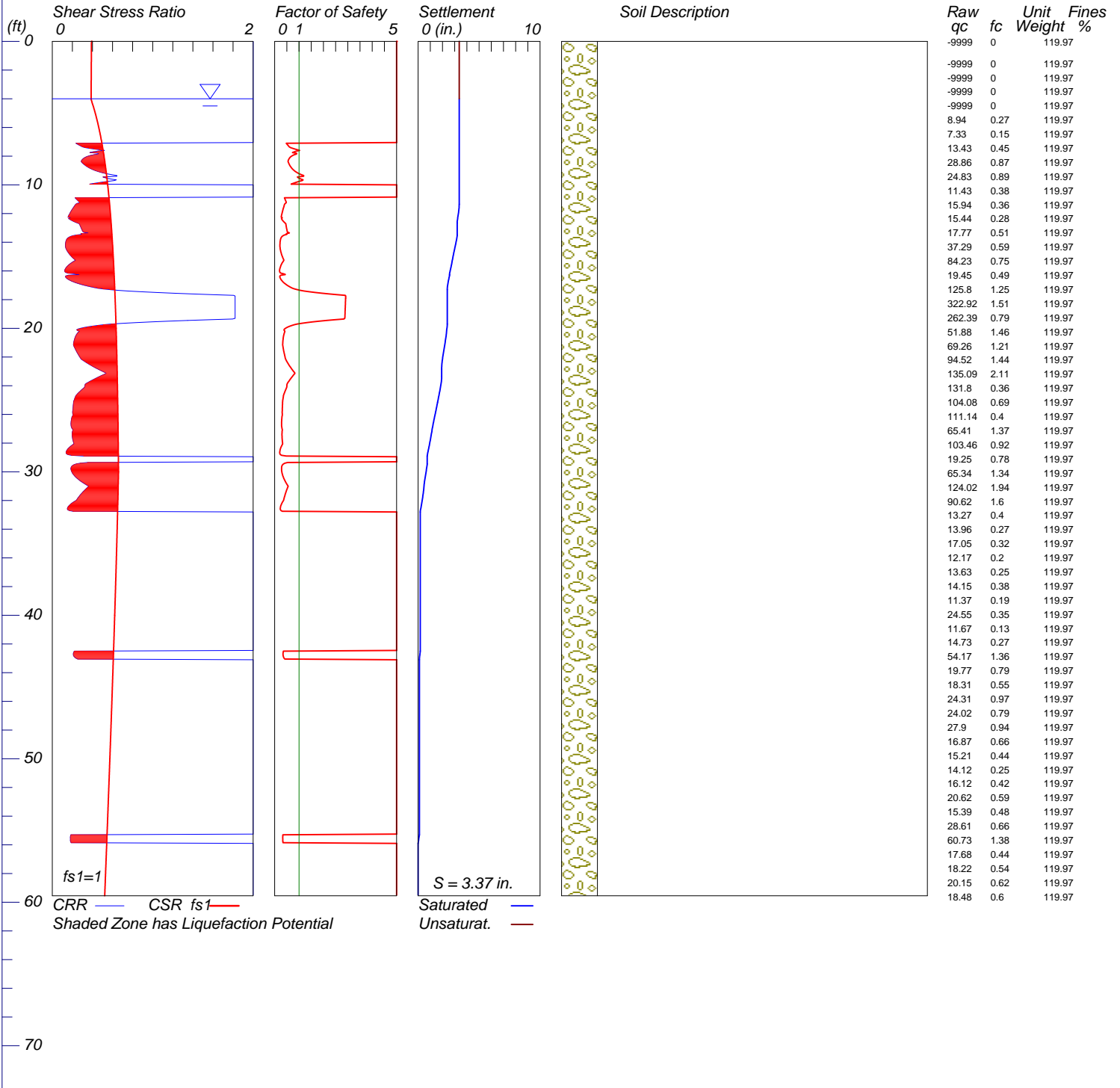

LIQUEFACTION ANALYSIS

NASA Hangar 1

Hole No.=CPT-88-19 Water Depth=4 ft Surface Elev.=21

Magnitude=7.9
Acceleration=0.6g

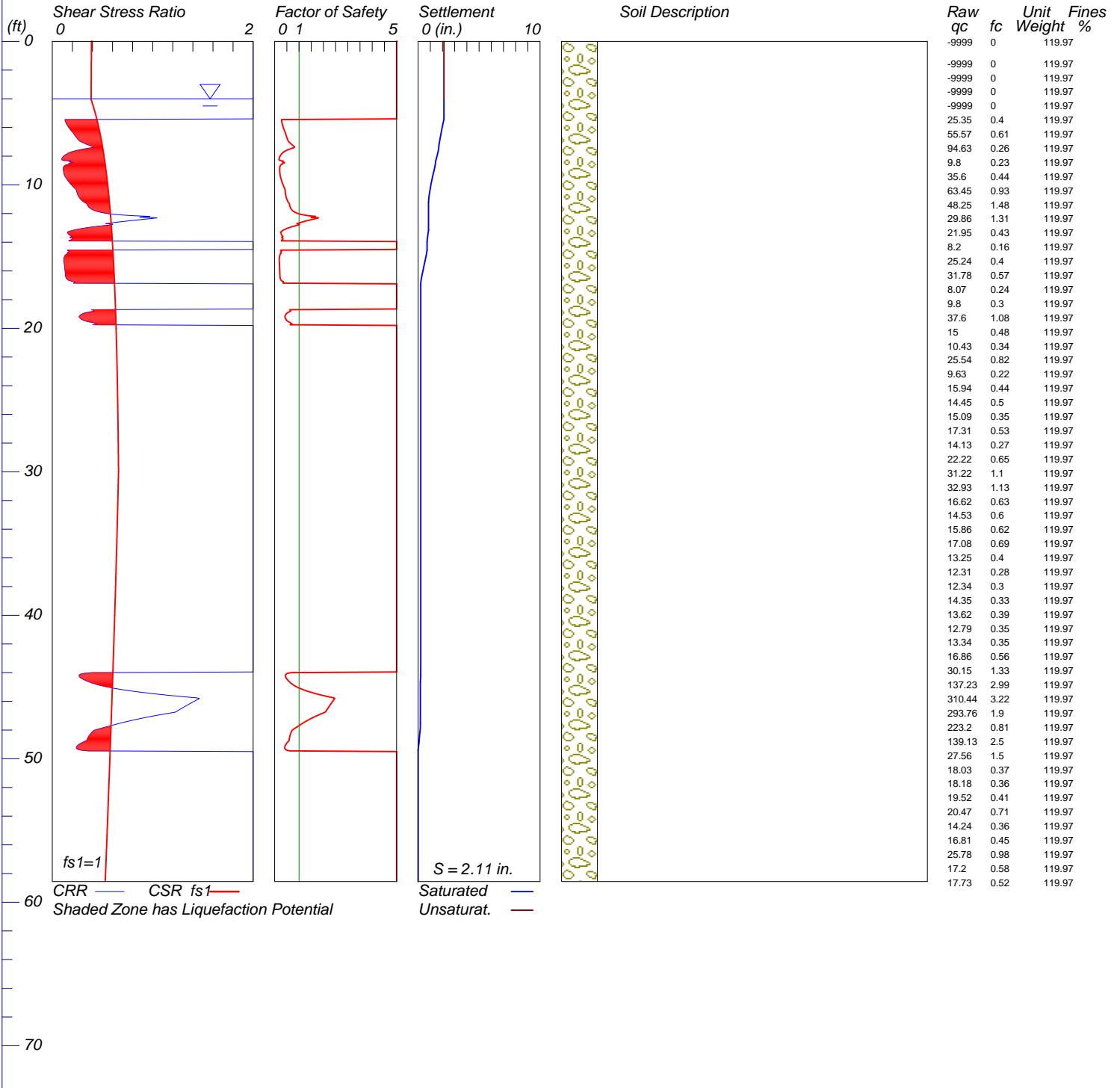

LIQUEFACTION ANALYSIS

NASA Hangar 1

Hole No.=CPT-88-21 Water Depth=4 ft Surface Elev.=21

Magnitude=7.9
Acceleration=0.6g

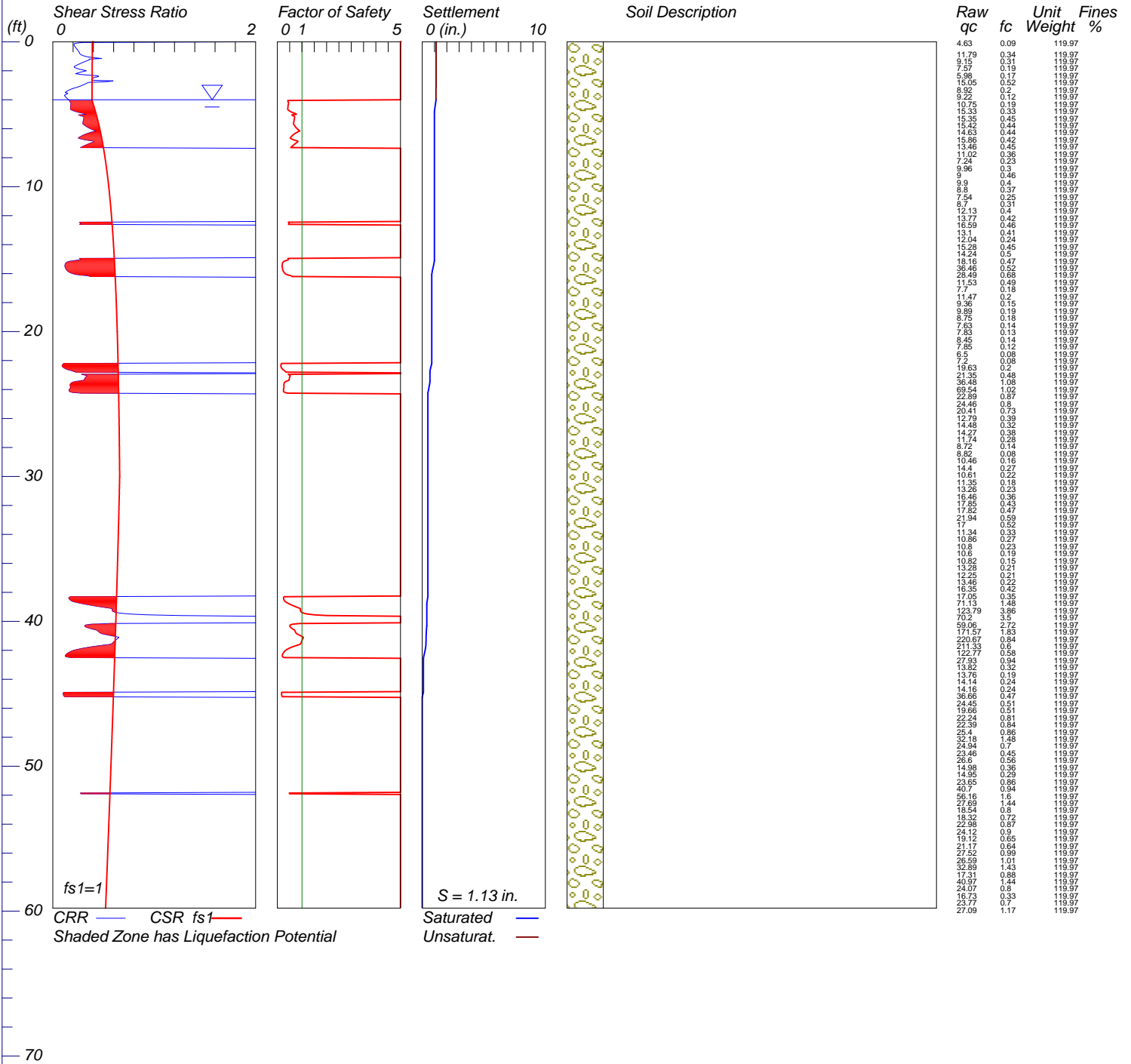

LiquefyPro CivilTech Software USA www.civiltech.com

LIQUEFACTION ANALYSIS

NASA Hangar 1

Hole No.=CPT-88-23 Water Depth=4 ft Surface Elev.=21

Magnitude=7.9
Acceleration=0.6g

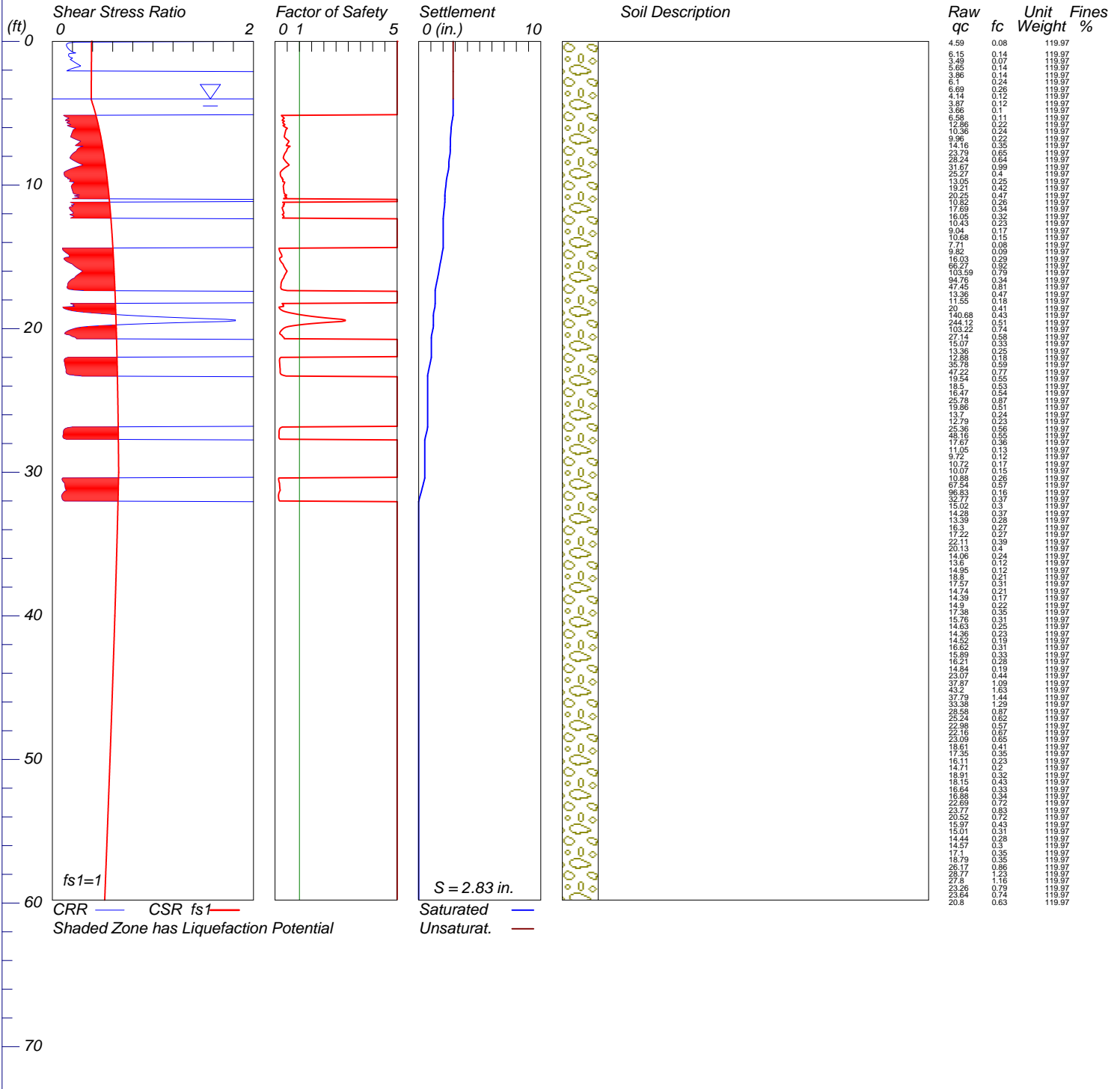



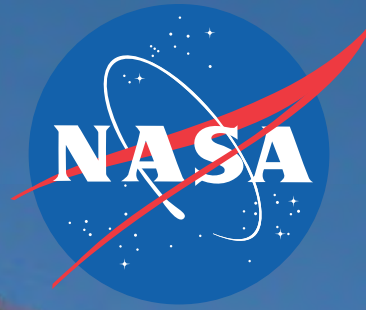

Condition Assessment and Rehabilitation Plan Hangar One

for NASA Headquarters and
Ames Research Center, California

Volume 2
Rehabilitation Plan



Hangar One- Ames Research Center, Moffett Field, CA

Introduction - Rehabilitation Plan



Figure 6.1

This Rehabilitation Plan provides analysis of various options for re-skinning and re-use of Hangar One at Ames Research Center Moffett Field, CA. As noted in the Condition Assessment report, Hangar One is a historic structure undergoing removal of contaminated materials. That process is being performed by and in coordination with the U.S. Navy, which had former stewardship of the hangar. A Rehabilitation plan is required to enable potential re-use alternatives, identify requirements and potential costs.

Included with the options analyses are fully detailed, line-item Cost Estimates for each Option and Material Alternative associated with each Option. These cost estimates have been generated following research and discussions of material replacement, material alternatives, historic impact, geotechnical improvements, structural upgrades and specialized construction issues.

Within the discussions of material replacement that follow in this Rehabilitation Plan are alternatives and specialized construction issues that are rated using a system for material alternatives developed by preservation architects and their understanding of the relevant historic requirements. These material alternatives are the recommendations of the CH2M HILL team, and have not been presented to or formally reviewed by either the state or federal preservation entities who have oversight responsibilities for the Shenandoah Plaza National Historic District.

This report includes Options A through F, with various alternatives included within several of the options. The following summarizes each option. Detailed cost estimates are provided at the end of this Rehabilitation Plan.

Option A – Basic Re-Skinning, Maintain Existing Hangar Use

Install a new exterior skin system on the structure. Occupancy of the building will be unchanged and will be re-used as an aircraft hangar. Included is a full structural assessment of the existing hangar structure per Executive Order 12491 and the California Historical Building Code. This includes a plan to remedy only those deficiencies determined as posing immediate hazardous conditions. Because the occupancy of the building has not changed from its original use, the CHBC does not require structural upgrades as the hangar continues to be utilized as it was originally designed for. This analysis, therefore, does not include existing risks from potential seismic forces. Full geotechnical ground improvements and structural upgrades to meet Executive Order 12491 and the current California Historical Building Code are not included. Option A, therefore, has additional risks compared to Option B because it does not address the possible seismic risks identified in the geotechnical analysis portion of this report, although, the risks are the same as they have been since the hangar's original construction. Option A also includes provisions for basic, code minimum building system services based on maintaining the existing hangar occupancy.

Future plans to exercise this option must include a plan to address Historic Preservation Conditions associated with re-skinning the hangar.

Option B – Re-Skinning with Upgrades (Geotechnical, Structural and Slab) and Re-Use as a Hangar to meet California Historical Building Code

Option B also includes reuse of the building as an aircraft hangar. In addition to the exterior skin replacement of Option A, Option B further includes repairs of structural deficiencies identified in the condition assessment. In response to geotechnical findings and structural analysis of Hangar One structural system perform geotechnical ground improvements and structural upgrades in accordance with the California Historical Building Code and Executive Order 12941 for a hangar occupancy type. Any soil remediation design and future geotechnical investigations need to take into account the contaminated groundwater at the site and must be approved by NASA to ensure that the contamination is not spread or migrated into areas that are currently not contaminated. The soil remediation and future geotechnical investigations must also not interfere with the Navy's remedial measures to clean up the ground water contamination. To accommodate current loading requirements, install a new concrete floor slab. Include basic, code minimum building system services based on maintaining the existing hangar occupancy.

In addition to replacing the external skin, Option B addresses structural deficiencies identified using current codes and analysis methods. Repairs under this plan, including soil improvements and structural strengthening, would bring this building up to a more useable, safer building for potential occupants.

Option C – Re-Skinning with Upgrades (Geotechnical, Structural and Slab) and Re-Use as a Hangar to meet California Historical Building Code with Historic Consideration

Include all improvements associated with Option B. Review and analysis of impacts to the historic resource shows that all improvements and structural upgrades associated with Option B can be done in a manner to not adversely impact historic status of Hangar One.

Option D – Adaptive Re-Use, Re-Skinning with Upgrades (Geotechnical, Structural and Slab) and Re-Use as a Higher Occupancy Level (Assembly, or Mixed Use)

Under Option D, occupancy of the building will be increased to assume potential alternatives for Assembly and Mixed Use occupancies. Because a change of occupancy requires that the building is brought up to current relevant codes, perform geotechnical ground improvements and structural upgrades to meet the current California Historical Building Code and in accordance with Executive Order 12941 for an assembly occupancy type. Install a new concrete floor slab. Include basic, code minimum building system services and egress system based on three levels of assumed occupancy.

Option E1 – Layaway Plan after Re-Skinning

Option E1 includes estimated costs for annual, cyclical maintenance for the re-skinned hangar.

Option E2 – Layaway Plan without Re-Skinning

Option E2 includes estimated costs for annual, cyclical maintenance for the un-skinned hangar.

Option F – Building Demolition

Option F includes estimated costs associated with demolition of the remaining structure, concrete foundations and concrete hangar floor slab.

Rehabilitation Plan – Hangar One – Ames Research Center, Moffett Field, CA

6.0 Introduction – Rehabilitation Plan and Options Analysis



Figure 6.2

This Rehabilitation Plan is provided by CH2M Hill and their sub-contractors, Garavaglia Architecture, Inc and Exeltech Consulting Engineers. Exeltech is a structural engineering firm with previous on-site experience performing structural analysis of Hangar One for gravity, seismic and wind vulnerability. Their previous study was published July 21, 2008. Garavaglia Architecture, Inc. is a full service architecture firm specializing in providing historic preservation architecture and planning services, working with Federal, State and local clients for over 25 years. They have a wide range of professional experience with the Secretary of the Interior's Standards and Guidelines for the Treatment of Historic Properties, National Environmental Policy Act (NEPA), California Environmental Quality Act (CEQA), and Section 106 compliance, and application of the California Building Code, California Historical Building Code, energy codes, and accessibility regulations (including American Disabilities Act) to a variety of building and structure types. The firm has an in-house staff of architects,

historians, and building conservation professionals whom exceed the Professional Qualifications Standards used by the National Park Service, previously published in the Code of Federal Regulations, 36 CFR Part 61 in either Historic Architecture or Architectural History.

While there are currently no definitive plans for re-use of Hangar One, this Rehabilitation Plan, along with the CH2M Hill Condition Assessment of Hangar One, provides a framework for potential and anticipated re-use of the hangar structure. Multiple potential future uses are considered and analyzed as part of this Rehabilitation Plan ranging from basic re-skinning while maintaining the existing hangar use, to re-skinning with geotechnical ground improvements and structural upgrades with improvements for potential higher occupancy such as an assembly space. An analysis provided for a Layaway Plan is included which lists the recommendations and associated costs with maintaining the exposed steel structure following the Navy removal action, but prior to any re-skinning work, as well as maintaining a re-skinned hangar structure.

The structural analysis and evaluation of the building is based on soil site class D forces and no appreciable differential settlement due to liquefaction. The geotechnical portion of the report, however, identifies the possibility of soil liquefaction and discusses soil remediation to meet the site class D forces. The building may be alternately evaluated with an additional non-linear structural analysis based on additional site specific geotechnical analysis, which may result in both reduced expected settlements and amplified accelerations. The non-linear analysis method may be included as a value engineering (VE)

option for the final design which may reduce the amount of steel needing retrofitting as well as reducing the amount of required soil remediation. The approach used in this report is intended to meet current building codes and standards; however it does not include all possible analysis methods. Based on the information available at the time of this study, the approach used in the geotechnical analysis portion of this report is conservative with regards to the settlement potential in order to capture the maximum probable required soil and steel mitigation.

The following Rehabilitation Plan provides a description of these various options and alternatives, with cost estimates included for each option and supporting documentation that includes written narratives, drawings and photographs. Topics addressed include Options Analysis, Material Replacement, Impacts to the Historic Resource, Code Requirements, Geotechnical Requirements and Ground Improvements, Constructability Issues and Structural, Mechanical, Electrical, Fire Protection and Life Safety Requirements.

Appendices are provided to include previously published reports, drawings and support documentation used and referenced in the preparation of this Rehabilitation Plan.

Because the Hangar is not thermally insulated, heating the interior space will be a difficult endeavor. Re-use as a hangar under any option does not include any provisions for heating the indoor hangar spaces, except the toilet rooms where heating is required by code and to protect plumbing elements.

6.A Rehabilitation and Re-Use Options

6.A.1 Option A – Basic Re-Skinning, Maintain Existing Hangar Use

Install a new exterior skin system on the hangar structure. Occupancy of the building will be unchanged and will remain as an aircraft hangar. Included is a full structural assessment of the existing hangar structure per Executive Order 12491 and the California Historical Building Code. This includes a plan to remedy only those deficiencies determined as posing immediate hazardous conditions aside from potential seismic risks. Full geotechnical ground improvements and structural upgrades to meet Executive Order 12491 and the current California Historical Building Code are not provided in this option. Option A also includes provisions for basic, code minimum building system services such as lighting, power and toilet rooms and means of egress system based on maintaining the existing hangar occupancy. For all work associated with this option include a plan to address Historic Preservation Conditions. The following items are of note with Option A:

- As part of the Condition Assessment a structural assessment was performed to identify upgrade requirements based on compliance with Executive Order 12491, Seismic Safety of Federally Owned or Leased Buildings and the California Historical Building Code. Provide a plan to remedy only the deficiencies identified in this analysis posing immediate hazardous conditions to the structural system aside from potential seismic risks. Structural retrofit requirements are discussed in more detail in section 7.0 Structural
- In executing Option A, plan to address historic impacts of all work associated with this option will be required (and is not included with this Rehab Plan). Historic considerations include visual impacts from exterior and interior perspectives and are more fully discussed in section 7.A Impacts to the Historic Resource

- Install a new exterior metal panel skin system, complete with expansion joints to match the visual aesthetic from the historic period of significance between 1932 and the end of World War II, 1945 (refer to the Condition Assessment for additional discussion). The new panel system shall be in two panel profiles (V-Beam and Mansard profiles) with concealed fasteners and shall cover the entire hangar structure, including the clam shell hangar doors (material alternatives are discussed in more detail in section 6.B, Material Replacement and Discussion of Material Alternatives)
- Replace the existing Built-Up Roofing (BVR) material with metal panels (Mansard profile) with concealed fasteners. Color shall match the other metal panel siding (material alternatives are discussed in more detail in Section 6.B, Material Replacement and Discussion of Material Alternatives)
- Install new windows with steel frames to match the existing profiles, sizes and locations (material alternatives are discussed in more detail in section 6.B Material Replacement and Discussion of Material Alternatives)
- Replace the 2x6 redwood timber decking located at the existing mansard metal panels and built-up roofing systems with an insulated metal wall panel system,(material alternatives are discussed in more detail in section 6.B Material Replacement and Discussion of Material Alternatives)
- Replace the existing egress and truck access doors as documented in the AECOM As-Built drawings dated 6.22.2011 (see also Appendix L). Provide ground level repairs to meet access, safety and egress requirements for egress doors and access included as part of re-skinning effort
- Repairs the existing concrete sill wall base to remove various finish treatments that have been applied over time. This concrete wall is approximately 48" tall by 36" deep and wraps around the hangar perimeter (with exception of the clam shell hangar doors). The repairs are intended to bring the existing concrete sill wall back to a consistent visual state
- Repair and service the existing clam shell hangar door motors, trucks, pivots, dog house mechanisms and any miscellaneous components to an operable condition. Install one new clam shell door motor
- Maintain access to the roof mounted beacon and obstruction lights. Minimal access is provided and will be in-place as a part of the Navy removal action
- Perform minor demolition work to remove existing concrete curbs and topping slabs left in place from previous interior structures. Existing 8" concrete slab capacity is discussed in more detail in section 7.0 Structural
- Install new electrical rooms to provide minimum code required ambient and exit lighting, power for aircraft maintenance, and to support the addition of new toilet rooms. Install new light fixtures for the high boy hangar space and all new interior construction including utility rooms and toilet rooms. Electrical requirements are discussed in more detail in section 10.0 Electrical, Public Address and Communications Systems
- Install new toilet rooms with minimum fixture counts to accommodate hangar occupancy. Minimum code required fixture counts for a hangar are 3 toilet/urinals and 2 lavatories for men and 10 toilets and 2 lavatories for women
- Install minimum code required HVAC systems for the new toilet rooms as discussed in more detail in section 8.0 Mechanical and Plumbing Systems
- Install minimum code required Fire Protection systems for the hangar and new toilet rooms as discussed in more detail in section 9.0 Fire Protection
- Build out of interior spaces and construction required for specific potential future tenant needs is not provided. Any build-out would be the responsibility of any future tenant(s)

Option A does not include improvements to the existing 8" deep concrete floor slab. The existing concrete slab provides slab drainage in portions of the hangar that was included with a slab replacement project in the 1970's. Slab capacities for the existing hangar floor construction are noted in more detail in section 7.0 Structural.

6.A.2 Option B – Re-Skinning with Upgrades (Geotechnical, Structural and Slab) and Re-Use as a Hangar to meet California Historical Building Code

Include all items noted in Option A above and, in addition, perform geotechnical ground improvements and structural upgrades beyond the minimal repairs associated with Option A. In addition to the items included with Option A above, the following items are required as Option B:

- As identified by the structural assessment required by Option A, perform Geotechnical Ground Improvements to reduce the likelihood of soil liquefaction during an earthquake and reduce the potential of building collapse (Geotechnical Improvement Requirements are discussed in more detail in section 5.0, Geotechnical Report, and 7.0, Structural). Any soil remediation design and future geotechnical investigations need to take into account the contaminated groundwater at the site and must be approved by NASA to ensure that the contamination is not spread or migrated into areas that are currently not contaminated. The soil remediation and future geotechnical investigations must also take into account the constraints in the USEPA MEW Study Area Record of Decision Amendment for the Vapor Intrusion Pathway.
- As identified by the structural assessment required by Option A, perform structural upgrades in compliance with Executive Order 12941, Seismic Safety of Existing Federally Owned or Leased Buildings in addition to structural upgrades to meet compliance of the current California Historical Building Code (Structural Retrofit Requirements are discussed in more detail in section 7.0 Structural)
- Install hangar floor slab reinforcing and/or replacement for use as an aircraft hangar and to remove potential lead contaminants in portions of the existing slab (the extents are currently unknown). Include two rows of trench drains running the full hangar length with the new slab installation to provide containment required by current building codes.

6.A.3 Option C – Re-Skinning with Upgrades (Geotechnical, Structural and Slab) and Re-Use as a Hangar to meet California Historical Building Code with Historic Preservation Consideration

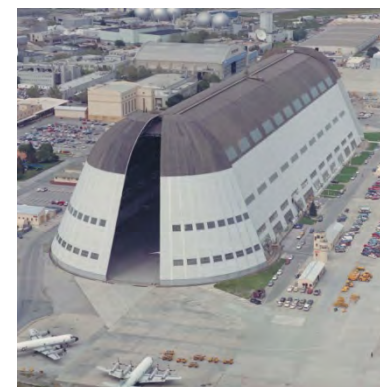

Figure 6.3

Include all items noted in Option A and Option B. Consider impacts to the historic resource of structural upgrades identified in Option B. Historic preservation considerations include visual impacts from an interior perspective. Review and analysis of impacts to the historic resource shows that all improvements and structural upgrades associated with Option B can be done in a manner to not adversely impact of historic status of Hangar One. The impacts from historic preservation consideration are more fully discussed as part of this Rehabilitation Plan under section 7.A Impacts to the Historic Resource.

6.A.4 Option D – Adaptive Re-Use, Re-Skinning with Upgrades (Geotechnical, Structural and Slab) and Re-Use as a Higher Occupancy Level (Assembly, or Mixed Use)

Include all items noted in Option A, Option B and Option C above. The Hangar One floor space is very large, therefore allowing for numerous potential uses. Other than a hangar, NASA is considering leasing the building for an appropriate use after the building is re-skinned. While the exact use cannot be predicted at this time, this report identifies basic infrastructure requirements for a variety of alternative uses. Install the basic necessary recommended improvements required to provide potential alternatives for assumed future occupancy of the hangar in lieu of those required for a hangar occupancy. These alternatives for assumed future occupancy are:

Assumed Occupancy Alternative – Museum or Exhibition Space

Previous studies have considered re-use of the hangar as a museum or exhibit space. Refer to Appendix M for studies completed by Page & Turnbull, Inc. The Page & Turnbull, Inc. studies analyzed multiple short, intermediate and long term potential uses that range from using half of the hangar to the full hangar. That study indicates potential egress locations that align with existing egress locations and include possible layouts for dinner/ceremony use, educational/exhibition use and museum use of the hangar.

Note: The previously issued Re-Use Guidelines prepared by Page & Turnbull, Inc. includes multiple possible layout options for the interior of the hangar in re-use configurations. These diagrams, with explanatory re-use guidelines occur starting on page 25 of the report. The report is included as Appendix M to this Rehabilitation Plan.

Environmental conditions within the hangar are very difficult to control due to the height and volume of the space, and due to the fact that the exterior walls and roof are not thermally insulated. Use as a museum space, exhibition space, or other space where the public could visit the building will require special attention to a heating, air conditioning, and ventilation (HVAC) system to address thermal comfort and indoor air quality. This report assumes the tenant will design and incorporate the required systems to address that tenants needs. Visual impacts will need to be coordinated with appropriate agencies, such as California Historical Preservation Office.

Assumed Occupancy Alternative – Mixed Use

With the goal of utilizing the large open floor area in order to maintain visual access to the building structure, Hangar One could be used for multiple uses such as:

- Sporting practice fields or specialized training.
- Training space for miscellaneous industries or trades
- Temporary movie/film sets – using the hangar structure for cover sets and productions could be temporarily constructed inside the hangar
- Storage rental space
- Office Space
- Retail Space – using the hangar structure for cover a retail environment could be created and constructed within the hangar footprint

Utility service provisions for such uses can vary greatly. To accommodate the highest potential occupancy, the services could be sized for the highest use now, or in the future. The cost estimate assumes worst case occupancy scenario of an A3 occupancy type.

The following items are of note with this Option D:

- Install new toilet rooms with minimum fixture counts to accommodate code required minimum fixture counts to support future occupancy levels. See the code review table, below
- Install basic code minimum required electrical and telecommunication improvements to support the future occupancy level requirements
- Install basic code minimum required HVAC improvements to support the future occupancy level requirements
- Install basic code minimum required Life Safety improvements, including egress improvements, fire alarm and basic fire suppression systems to support the future occupancy level requirements
- Possible reductions may be made in the Life Safety systems requirements as allowed by the Ames Building Official and California State Historic Preservation Office due to the historical significance of the facility
- Restore utility services to the building site and provide limited service to the building for assumed use/occupancy requirements

A change in occupancy requires that a building comply with current relevant building codes. Because Hangar One is a historic building, that code is the California Historical Building Code. The current version of the California Building Code will also apply to items such as minimum toilet fixture counts and minimum egress width requirements. To give an order of magnitude to the impact of these code requirements the following table is provided to demonstrate the calculated occupancy load, minimum fixture counts and minimum egress widths for a representative sample of occupancies such as Assembly (A-3), Educational (E), Business (B) and Factory Industrial (F) occupancy types:

330,000 sf	A-3	E	B	F
Occupancy factor	15	50	100	100
occupancy load	22,000	6,600	3,300	3,300
min. toilet fixtures men:				
min. fixture factor	1:125	1:50	*	1:100
toilet/urinal	88	66	67	17
lavatory	55	66	43	17
min. toilet fixtures women				
min. fixture factor	1:65	1:50	*	1:100
toilet	170	66	67	17
lavatory	55	66	43	17
Egress width w/ sprinkler	3,300"	990"	495"	495"
# of 3' wide doors required	91	28	13.75	13.75
Egress width w/o sprinkler	4,400"	1,320"	660"	660"
# of 3' wide doors required	122	37	19	19
Assumes an occupancy split of 50% male, 50% female				
*For B 1:25 for first 50, 1:50 for the remainder				

Figure 6.4

Considerable parking and site development will be required with any of the three previously mentioned future uses of the hangar. Costs for this design and construction have not been included with the following cost estimates. Final Code compliance and additional infrastructure requirements and construction will be the responsibility of the future tenants based on their specific needs.

6.A.5 Option E1 – Layaway Plan after Re-Skinning

Option E1 includes annual cost and maintenance requirements associated with the re-skinned hangar per Option A. These costs would be based on no interior use or occupancy, and would continue until a tenant moves in and takes over the facility use. The following list is not intended to assign responsibility to NASA as some items on the list may be included with the Navy removal actions. The list is provided to show that there are costs associated with the hangar in “stand-by” mode. The following items at a minimum will need to be considered:

- Ground maintenance for vegetation and weed control
- Electrical power for basic lighting and hangar door operation
- Annual roof inspection
- Special steel coating inspection every 3 years with potential touch-up required. The life expectancy of the coating will require full re-application 20 years after initial application. Duration of this requirement

shall be for 50 years minimum (basic coating maintenance is included with a 12-year warranty as part of the Navy removal actions)

- Cleaning of perimeter trench drains
- Rodent eradication maintenance
- Clam shell door inspection and maintenance (door pivots, motors and trucks)
- Potential ongoing remediation of sediment ponds and monitoring wells
- General hangar material maintenance and repair to caulking, paint & coatings, windows and doors

6.A.6 Option E2 – Layaway Plan Without Re-Skinning

Option E2 includes annual cost and maintenance requirements associated with the un-skinned hangar based on the exposed, steel structure remaining in place prior to any re-skinning projects. The following are assumptions associated with this option. The following list is not intended to assign responsibility to NASA as some items on the list may be included with the Navy removal actions. The list is provided to show that there are costs associated with the hangar in “stand-by” mode. The following items at a minimum will need to be considered:

- Ground maintenance for vegetation and weed control
- Bird monitoring and repairs for exposed steel structure
- Special steel coating inspection every 3 years with potential touch-up required. The life expectancy of the exposed coating may require full re-application approximately 12-15 years after initial application
- Annual monitoring with potential repairs as required for steel connections due to corrosion caused by weather exposure (basic coating maintenance is included with a 12-year warranty as part of the Navy removal actions)
- Potential ongoing remediation of containment pond
- Cleaning of perimeter trench drains
- Protection of electrical vaults and existing utility systems left in place following removal action
- Rodent eradication maintenance
- Maintenance and monitoring of mezzanine decks and flat steel surfaces for the potential of water collection and corrosion

6.A.6.1 General Layaway Discussion Items

In addition to the previously noted items included in options E1 and E2 the care of the hangar or hangar structure will be critical to the long term protection and future operability of the hangar. This discussion is intended to further expand on these items, although it is possible that additional items may arise during and following the Navy’s removal action.

- Mezzanines- The existing mezzanines will be left in place following removal action. These mezzanines include horizontal surfaces that will collect and hold water as they are exposed to weather. Included in the Navy’s removal action is a coating the mezzanine surfaces that will help protect them (see discussion on special coatings in the Condition Assessment). If the mezzanines are left exposed for a long period of time it may be necessary to consider drilling holes in the mezzanine deck to allow for water to drain through the deck. This potential solution would require special coating touch-up. Any additional horizontal surfaces aside from the mezzanines will also require this consideration.

- **Electrical Vaults-** There are six existing electrical vaults with flat concrete roofs at the hangar interior. The Navy will provide weather protection for these vaults as part of the removal action. The protection of these vaults will be critical to the long term operability of the electrical systems of the hangar.
- **Sumps-** The contractor responsible for the Navy's removal action has temporarily sealed the utility tunnel to keep water out of it as a result of their activities. There is an existing sump pump in the tunnel intended to deal with water that is present in the tunnel.
- **Perimeter Drain-** The perimeter trench drain that circles the exterior of the hangar. This drain system leads to a containment pond that is cleaned annually by the Navy. Following the removal action and after the hangar is turned over to NASA this containment pond will require regular monitoring and in the worst case scenario annual cleaning. It is reasonable to expect that once the removal action is complete, and contaminated materials are completely removed from the structure that the annual cleaning will be reduced or eliminated altogether. It is difficult to know the requirements until regular monitoring occurs.
- **Steel, Steel Coatings and Steel Connections-** The special coating applied to the steel structure has been discussed previously in the Condition Assessment. As part of the coating being installed during the removal action a 12-year warranty will be provided. The coating manufacturer recommends that the coating be inspected every 3-years and touch-up provided as necessary. This is likely acceptable for a majority of the surfaces with the exception of the connections of the structural steel frame that will be left in place. These connections will be of particular interest if there is any movement that occurs based on wind loading, seismic activity or natural thermal movement. This potential movement will likely adversely impact the integrity and continuity of the coating system. Based on this potential we have recommended in other locations of this report that the inspections occur annually.
- **Miscellaneous Special Coating Discussion-** The special coating applied to the steel hangar system will be impacted by the installation of a new skin system. This will require special attention to ensure that the integrity and continuity of the coating is kept intact otherwise touch-up will be necessary. A technical representative of the coating manufacturer will be required. Following the installation of a new exterior skin system on the hangar the special coating will still require periodic inspection to ensure it is kept intact. Following the 12-year warranty period included with the Navy's removal action the ongoing inspections and activities associated with the special coating will be NASA's responsibility.
- **Containment Pond and Soil Conditions-** There is a containment pond associated with Hangar One that is currently being monitored and cleaned annually. It is difficult to predict and not currently known whether contaminated soil or groundwater will be encountered. Further testing and analysis will be required to determine the mitigation requirements and whether the responsibility lies with NASA or the Navy. Currently the Navy is responsible for groundwater remediation and vapor intrusion mitigation in addition to the removal action that has been described previously in this Conditional Assessment and Rehabilitation Plan.

6.A.7 Option F – Building Demolition

Following removal action currently in progress by the Navy, the remaining portion of the facility requiring demolition includes, but may not be limited to the existing steel structural frame, concrete foundation system, concrete slab, hangar door and components (motors, trucks, pivots), miscellaneous site utilities and utility tunnels (refer to the Condition Assessment for further description and information), demolition of historic buildings 32 and 33 that are linked to Hangar One, cultural resource impacts mitigation, site paving and improvements.

Demolition and removal of the existing facility components shall be completed in a manner that accounts for the proper removal and disposal of contaminated materials- lead primer and PCB coated steel, potentially contaminated concrete slab containing lead dust and site/ soil remediation.

In addition to removal of contaminated building and site elements the soil and groundwater may require remediation (additional investigations will likely be required to determine the full requirements). Previous, limited subsurface exploration has been conducted by NASA at the south end of the hangar for soil and groundwater contaminants. Copies of the boring result maps are included as Appendix J. It is currently not known if soil or groundwater remediation will be required. As part of building demolition, additional subsurface testing may be required to determine the full extent of remediation. For purposes of the cost estimate we have assumed that soil to a depth of 3' below the hangar will be remediated.

Following complete building and site demolition, a level gravel surface shall be provided. As coordinated with the Airfield Management Office in addition to the gravel surface, a new airfield security fence should be provided between the gravel pad and airfield. Preventative maintenance is also required to deal with weed and vegetation growth. There is also a potential for the site becoming a burrowing owl habitat. Preventative measures are required to ensure that this does not occur.

6.A.8 General Re-Skinning and Re-Use Discussion Items

As previously noted, the metal panel re-skinning effort will be made to reflect the visual aesthetic of the hangar facility from its period of significance. This aesthetic is of a monochromatic exterior finish. The existing rounded, black roof portion of the facility was a later addition and it is not recommended to be replicated in the re-skinning effort.

With the basic plan of re-skinning the building and reuse as a hangar, the previously noted options have been put together with the minimal, basic assumptions made for interior construction requirements. With the improvements noted for Options B and D above, this will provide a facility ready for a future tenant should NASA choose to lease the building to others. Tenant Improvement requirements and specialized use requirements may vary as different potential occupancy uses are considered, researched and developed. Specific designs and layouts for future specialized re-use have not been considered as part of this Rehabilitation Plan and Options Analysis. These requirements will be the responsibility of the incoming tenants.

The exterior design and visual aesthetic of the hangar is one of the significant characteristics of the historic structure. Therefore, any additions to the exterior skin which are required for future use, including added egress doors and access openings, must be done in a manner consistent with the original hangar design. New openings shall be located within the glazed window areas to provide a consistent spacing and rhythm.

Additions and modifications to the exterior skin as part of future re-use and or Tenant Improvement will be subject to all required state and federal submittal and review processes for historic preservation. General discussion of these processes and potential requirements are discussed in section 6.C Impact to the Historic Resource of this Rehabilitation Plan.

As part of all re-skinning construction efforts, the following will need to be accounted for as required by the local NASA Ames Research Center requirements

FOREIGN OBJECT DAMAGE (FOD):

Foreign Object Damage (FOD) is the damage caused to an aircraft or an aircraft engine by Foreign Object Debris (also abbreviated as FOD). Metal fasteners, plastic material, a coffee cup, or rocks can be ingested into aircraft engine and cause damage. Also an object on the runway can be thrown up by aircraft tires and damage the aircraft.

All construction work occurring on or adjacent to an airfield must include a FOD Control Program and the contractor performing any re-skinning work, or work associated with any future occupancy shall include this requirement. The FOD control requirements will vary depending on the project, materials, and location. Below are some examples of FOD control methods:

1. Train all personnel on the damage that can be caused by FOD and the importance of securing all garbage to prevent it from blowing on to the airfield.
2. Provide adequate garbage cans and garbage can servicing to prevent garbage overflow.
3. Provide covered garbage cans in outdoor areas.
4. If possible, provide a fence around construction areas that is adequate to capture blowing debris (a chain link fence with fabric/netting cover is common).
5. Provide personnel with a phone number to call if FOD gets onto the airfield.

WILDLIFE ABATEMENT (WA):

The Navy is developing a wildlife strategy for the hangar's environmental project as the existing siding is removed. The goal is to prevent any roosting swallows or hawks or nesting grey foxes, etc, from migrating into the hangar.

Any Contractor working on Hangar One as a part of any re-skinning work, or work associated with any future occupancy will be required to maintain the Navy's strategy or adjust it as the new siding is installed. NASA cannot allow the hangar to become filled with bird droppings that could present a health hazard or corrode the new coatings of the steel frame provided by the Navy. Further research by the future design team and/or contractor will be required to allow the new façade to be both weather and wildlife resistant.

6.B Material Replacement and General Discussion of Material Alternatives

This Rehabilitation Plan explores multiple alternatives for material replacement, as well as the cost implications and impacts to the historic resource of different material selections. Wherever possible, recommendations are made on materials based on historical relevance. In some cases due to cost, availability or potential sourcing issues, recommendations are included for alternate materials or installation methods. In most cases the ideal installation of new materials will match the simplicity and elegance of the existing installation and attachment methods.

Certain re-use options may require the addition of non-original building components to bring the facility up to date with current code requirements. It is important, from a historic preservation standpoint, that any alterations to the building be visibly distinct from the original condition yet still compatible with the original design and material selection. Any material or structure added must appear as an obvious retrofit, and in no way replicate the appearance of the original construction. The intent is to avoid any historic ambiguity

that may arise between visibly similar "add-on" elements and original building features. Any proposed changes should comply with the Secretary of the Interior's Standards for Rehabilitation.

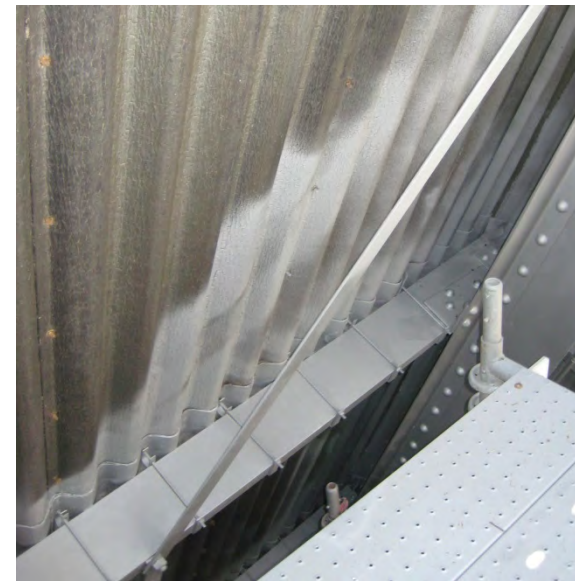

Figure 6.5

As this project is located on a federal property and could be federally funded or by others, the material selection, sourcing and procurement processes must satisfy all federal requirements.

6.B.1 Hazardous Materials Implications

The existing steel structure coating contains hazardous compounds; at the time of the re-skinning process, all steel members will have already received a protective coating as part of the Navy removal action to prevent the migration of environmentally compromising chemicals. If at any point during the re-skinning process, the coating is compromised, either by drilling, accidental scraping or excessive scratching, the affected area will need to be treated and/or re-coated to maintain the integrity of the protective coating (refer to the

Condition Assessment for detailed discussion of the protective coating system). For this reason, and to maintain

compatibility with the original construction details,

panel attachment methods discussed in this report will primarily involve non-intrusive anchorage systems as the preferred attachment method. Drilling or mechanically fastening directly to the existing structure has been considered and is a possibility, however will require analysis of the attachment to the structure as well as touch-up of the protective coating on the existing structure. Any waste materials resulting from attachment to existing coatings will require these materials to be considered hazardous. Therefore, these materials must be handled and removed from the site in accordance with local, State and Federal regulations.

6.B.2 Metal Wall Panel Replacement

The original metal enclosure system at Hangar One is comprised of two primary panel profile types; a corrugated, V-beam panel (referred to herein as panel profile one, V-Beam), and a corrugated, mansard panel with a radial bend (referred to herein as panel profile two, Mansard). Panel profile one was applied over a horizontal steel C channel sub-frame at the non-radial portions of the hangar walls. A mechanical attachment mechanism, utilizing carriage bolts and clips was used to fasten the V-beam panels to the C channel substructure without penetrating or compromising the steel members. At the +/-132' elevation point above ground level, the profile of the hangar structure transitions from a tangent to a radial curve; at this transition point, redwood decking was applied over the structure of the hangar framing to provide an attachment point for panel profile two. The mansard panel is fastened directly to the redwood substrate with mechanical fasteners. Refer to record drawing [AM4---0001-A37](#) for corrugation profiles and details of original attachment methods. Additionally, refer to the AECOM As-built drawings for details of present day, field verified detail conditions.

For the attachment of the V-beam siding over existing C channel members, two alternatives are considered. Both attachment methods will follow the original methods of attaching to the existing steel structural channels with j-clip fasteners to minimize the disturbance of coated steel surfaces. In each case the existing structural steel surfaces are covered with a protective coating (refer to the Condition Assessment section 2.E.7 for detailed discussion) that will need to be maintained through attachment of new metal panel systems.

Alternative 1 – Provide single panels in sizes to match the existing construction (approximately 2'-6" wide x 9'-0" tall), individually attached to the hangar structure with the "J" Clip fastening method, in order to reduce existing steel surface disturbance. Refer to the installation diagram in section 12.C Installation Diagrams & Conceptual Details for phasing and method of panel attachment. Additionally, refer to the AECOM As-built drawings sheets M001-1100-A7.36 through M001-1100-A7.49.

Alternative 2 – Provide a panelized assembly method; where large segments of panels will be fabricated off site or on-site but on the ground, and installed in large, modular sections. The height of the panelized modules will be constrained to a single panel height, and multiple panels could be fastened to a length of tube steel to allow for increased panel installation speed. Fastening method used shall leave minimal protruding surfaces, in order to accommodate flush installation of the next panel module. Panels will be delivered to the site via flat bed, and hoisted into place with a crane; for this reason, module length will be restricted by the flat bed capacity and crane lifting logistics. A "J" clip fastener method, similar to the original attachment technique will be utilized to install the upper edge of the panel modules. Lower edges will be fastened with self drilling screws to panels below at corrugation peaks. Refer to the installation diagram in section 12.C Installation Diagrams & Conceptual Details for phasing and panelization installation attachment.

Attachment using the j-clip fasteners will allow for potential thermal expansion and contraction resulting in abrasion of the existing protective coating at the existing C channel sub-frame. Provide an appropriate material to either the j-clip or the channel similar to Teflon that will eliminate or minimize the potential from damage to the protective coating. This material will need to be included with the final design and engineering of the metal panel systems.

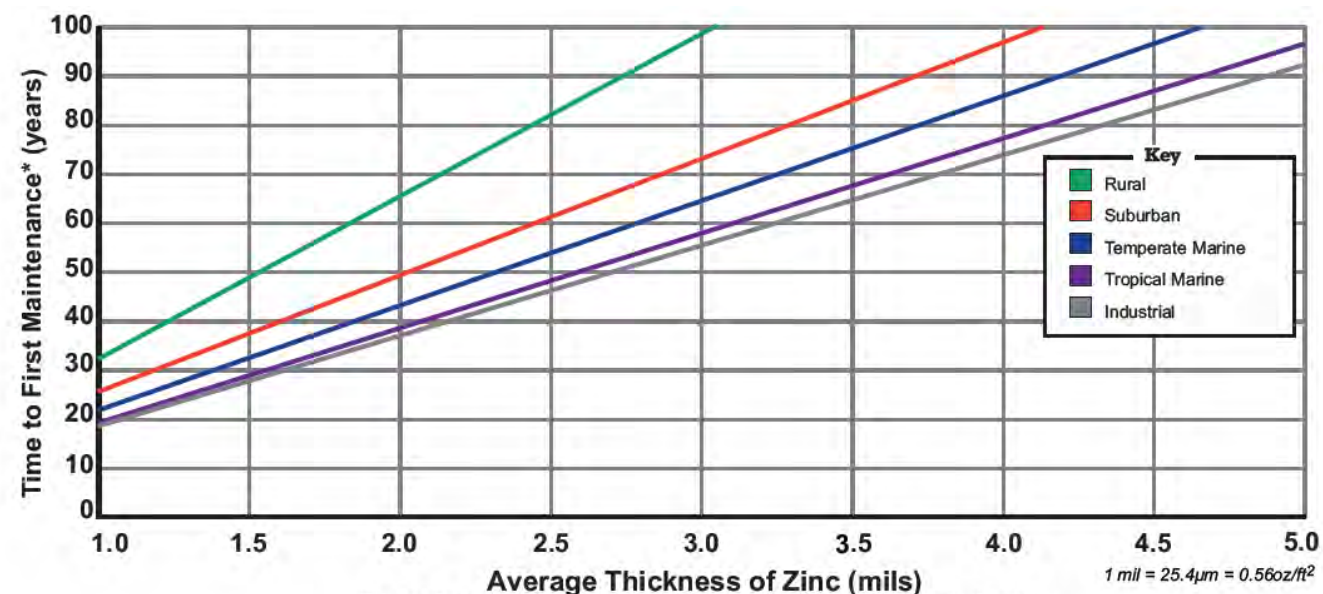

Figure 6.6

The corrugated metal panels should be galvanized with the thickest available galvanizing at the time. A survey of national steel suppliers shows a maximum available galvanizing thickness of G360 (3.24 mils thick), although the number of suppliers capable of such a thick coating is very limited. This has the potential to provide a maximum of 75 years without maintenance in a temperate marine environment such as Moffett Field (see the below figure from the American Galvanizers Association). Thinner galvanizing such as G235 (1.98 mils thick) is more readily available, but only has the potential to provide a maximum of 45 years without maintenance. Painting the steel after galvanizing may prolong the time until the steel rusts.

Additional painted coatings can be added to the galvanized panel, or a painted coating can be installed on a Galvalume G60 or G90 coated metal panel, which is a more standard practice in the case of architectural finish wall panels. Thicknesses of the painted coating would be approximately .5 mil per coat and a 4-coat baked on Kynar finish is recommended if an exposed, galvanized panel is not provided. The intent of the coating system is to provide a coating that will last approximately 100 years, but not be warranted for 100 years. Most painted coatings can be warranted for between 20 to 30 years. If it is determined that a painted coating is to be provided for additional longevity a custom color shall be provided to match the visual aspects of the original metal panels. Samples and mock-up panels will be required for review and approval by NASA and the Ames Research Center.

Regarding the longevity and integrity of the coating systems on the metal panels a 100 year life expectancy is the goal. As noted above it appears that the best way to achieve these is with a steel panel, galvanized to the thickest extent possible (3.24 mils) and with a multi-layer painted coating. For planning purposes and in taking a conservative approach it is reasonable to think that this should last maintenance free for 50 years with potential re-painting required at 10-15 year increments for the final half of the 100 year life expectancy period. Independent of the type of coating applied to the metal panels periodic and ongoing inspection will be required to ensure that when areas of coating deficiency are identified that they can be re-coated or repaired to extend the life of the hangar skin. Specifically area where damage occurs, panel seams and joints will be long term areas of concern. The cost estimate that accompanies this Rehabilitation Plan provides incremental costing to provide NASA with options in coating systems. Starting with a base bid of standard steel galvalume and painted coating, followed by two increased thicknesses of galvanization and painted coating as previously noted.

6.B.3 Roof Replacement

As originally constructed there is a portion of built-up roofing (BUR) at the crown of the hangar. CH2M Hill was requested to consider replacement of this roofing material with a permanent metal panel system. A disadvantage of the BUR is that there is periodic re-roofing that is required. With the access difficulties due to the height and shape of the hangar re-roofing becomes difficult, costly and dangerous. Therefore, it is ideal that a metal panel system be provided over the entire mansard and roof portions of the hangar.

As with the mansard metal panels, the BUR was originally installed over redwood 2x6, tongue & groove decking (refer to section 6.B.5 for discussion of redwood decking). Any installation of metal roof panels will require proper detailing to account for the curved roof surfaces.

There is an existing continuous roof vent (refer to sheet 7.67 of the AECOM As-Built Drawings, included as Appendix K) and roof access catwalk that run the length of the hangar at the roof. The ridge vent shall be replaced completely to match the overall visual appearance of the original construction detailing with

mechanical modifications for ventilation as discussed in section 8.0 Mechanical and Plumbing Systems for more detailed requirements. Refer also to section 12.C Installation Diagrams and Conceptual Details for conceptual detail requirements. As originally designed and constructed the ridge vent was intended to help mitigate vapor condensation from occurring in the ceiling of the hangar. The roof access catwalk has been partially replaced and updated as part of the Navy's removal action scope of work. This catwalk provides access to the beacon obstruction lights on the hangar roof. An OSHA upgrade to the railing height has not been provided by the Navy.

Installation of the new metal roof panels will need to be coordinated with the ridge vent and existing catwalk. Limited access below the catwalk is provided and detailing of the roofing and installation will need to maintain beacon access.

6.B.4 Window Replacement

The hangar is provided with four horizontally oriented sets of windows along the east and west facades and two sets of horizontally oriented windows on the north and south facades, which are located in the "clam shell" hangar doors. The windows occur in two distinct profiles. These profiles are identified in this report as Window Profile One – Flat Wired Glass and Window Profile Two – Corrugated Wired Glass.

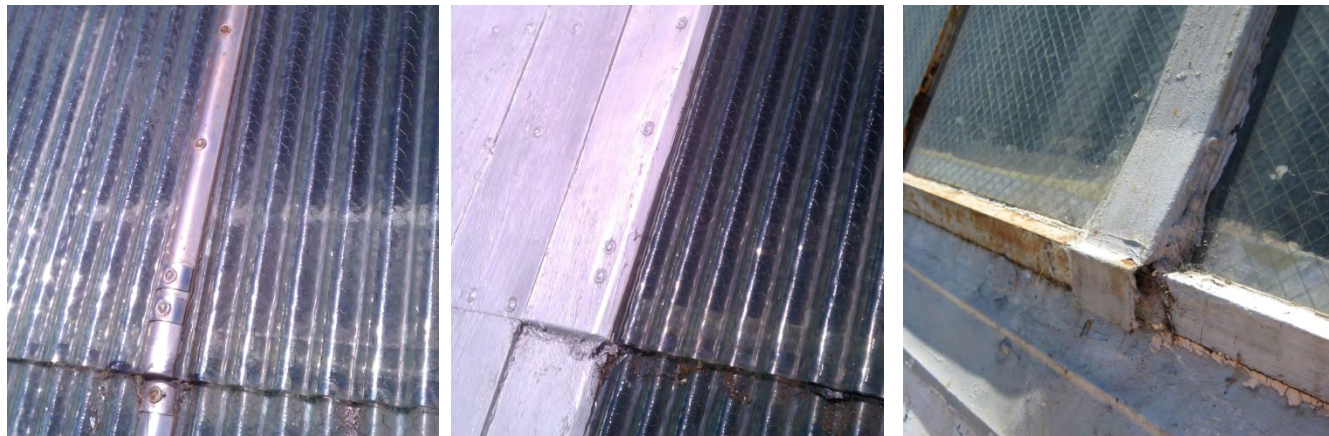

Figure 6.7

Figure 6.8

Figure 6.9

Along the east and west facades, the bottom two horizontal bands of windows are profile one – flat glass, and the upper two horizontal bands are profile two – corrugated glass. Each horizontal band is comprised of uniformly sized, smaller window panels approximately 2 feet wide by 3 feet 8 inches tall varying in quantity based on their location.

The existing windows, in particular the corrugated glass, are an important historic preservation feature of the existing hangar. Ideally the existing windows and frames would be salvaged and re-used. However, due to the poor existing state of the glazing and steel frames they are being removed as part of the Navy's removal action. Left in place are the steel support members that connect between the steel structure and the window frames. As part of the re-skinning project of the hangar new steel window frames and glazing will need to be provided to the requirements noted herein.

The most simple, preferable and recommended replacement for the windows is to replace the frames and glazing, in-kind, to match the detailing and attachment of the original construction. Readily available wired, corrugated glass to match the existing construction is difficult to find in the United States and difficult to find

without custom manufacturing from international sources. The recommendations of this Rehabilitation Plan are to require that custom manufactured wired glazing be provided to match the corrugated and flat glass window panels. Refer to the AECOM As-Built Drawings M001-1100-A7.01 through M001-1100-A7.22 for additional information.

Material alternatives for window replacement are discussed in more detail in sections 6.B.10 Alternate Material Discussion and 6.C.4 General Discussion of Replacement Material Suitability and Guidance Criteria.

6.B.5 Wood Decking Material Replacement Options (non-combustible)

There are existing 2x6, tongue and groove redwood decking that occurs below the mansard metal panels and built-up roofing materials. This decking is coated with contaminated materials and is in the process of being removed by the Navy as part of their removal action. Once this decking has been removed it will require replacement with similar materials or a different material type when the hangar is re-skinned. We have analyzed two alternatives:

Alternative 1 – Replace the existing redwood decking with 2" thick insulated metal sandwich panels. These panels are readily available in multiple sizes and finishes and can be manufactured in project specific lengths. Use of a 2" panel would meet the structural requirements and provide roof insulation on the hangar while maintaining a 2" thickness to match the existing detailing and interface with the metal siding below. The interior face of the panels can be finished to meet any historic preservation visual requirements.

Alternative 2 – There is a current proposal for a percentage the existing redwood decking to be salvaged during the Navy's removal action. Since the original decking is contaminated, the contractor has proposed running the wood through a planer to remove potential contamination. One advantage of this approach is the re-use of the existing materials, which may be appealing from a historic preservation standpoint if it can be determined that the redwood decking contributes to the historic significance of the hangar structure. Disadvantages of this approach include:

- Potential cost at \$1,000,000
- Storage of the materials between salvage and reinstallation
- It is difficult to guarantee that the planing from 2" depth to 1-1/2" depth will completely remove all contaminants. 1-1/2" is the required thickness to resist the structural loads
- The existing deck is tongue and groove. The tongue portion of each board was coated with the PCB paint material prior to installation. These tongues will be removed as part of the salvaging process
- In addition to the sectional dimensions of the lumber changing the ends will likely be cut down due to nails splitting the lumber during the removal process
- The removal of the planks would likely require detailed cataloguing to ensure that each piece is placed in its original location, making re-use challenging. The Navy's Contractor responsible for the removal action has not been cataloguing the materials as it has been removed
- The redwood decking at the hangar doors and a small percentage along the sides of the hangar are not salvageable
- In order to meet the requirements of the Center's Fire Marshall, the redwood decking would require application of a fire treatment material in order to make it non-combustible

Based on this list of disadvantages the replacement of the redwood decking members with 2" insulated metal sandwich panels is a more viable and cost effective solution.

6.B.6 OSHA Update – Catwalks & Vertical Access

There are two distinct catwalk systems serving the hangar; an interior catwalk system comprised of eight different levels spanning the length of the hangar on both sides of the structure, and a roof top access catwalk, running the length of the structure and offset to the side of the ridge vent that runs along the hangar's ridgeline. As part of the Navy's removal action, the rooftop catwalk wood planks are being removed and replaced with metal treads to maintain access to the existing beacon and obstruction lights.

The interior catwalks were originally planked with redwood decking installed over horizontally spanning wooden nailers, fastened to steel angles. Due to contaminants, all wood material is being removed from the structure. The catwalks will be stripped down to their steel framing and the coating noted in the condition assessment applied to the steel. The steel members used to construct the interior catwalk guardrails also serve as a truss system, providing structural support for the catwalk over 18'-0" spans. Due to the structural nature of the guardrails and the historical significance of the building, these truss members shall remain intact. Any alterations made for code compliance upgrades shall not compromise the structural integrity of the catwalk truss system or visually change the appearance of the existing catwalk elements.

If the catwalks are to be utilized during the re-skin process or as part of building re-use, there will be two major concerns associated with bringing the catwalks up to code compliance. All catwalk areas to be rendered serviceable will require the installation of a new flooring system, and may require a modification of guardrail configuration to meet current code requirements. A new flooring system is required as the existing wood flooring will be removed as part of the Navy removal action. As part of a potential guardrail improvement to meet OSHA requirements, a toe plate would need to be provided at the deck level.

To avoid modifications to the rail height, an optional method of modifying the catwalks would be to re-floor the catwalks with a non-combustible, steel grating system, manufactured in modular sections and supported off of existing steel angles. These grating sections would allow for easy installation, with a simple lay-in application. The wood decking previously installed was fastened to wood nailers attached to

and spanning spanning the length of the lower steel frame. With these wood nailers removed, and a low profile steel grate installed, several inches of guardrail height increase may be achieved. This height increase will help to bring the guardrail up to current code compliance and would require review with the historic preservation review authorities as it would not visually match the original construction. Refer to the Catwalk Rail height Improvement Conceptual Detail in section 12.0 Support Drawings.

The catwalk guardrails, as originally designed, were installed at a height of 38" above the deck elevation. Current code requires a guardrail height of 42". This four inch height increase must be achieved either by retrofitting a new (visually different) guardrail extension to the top angle, or by lowering the deck

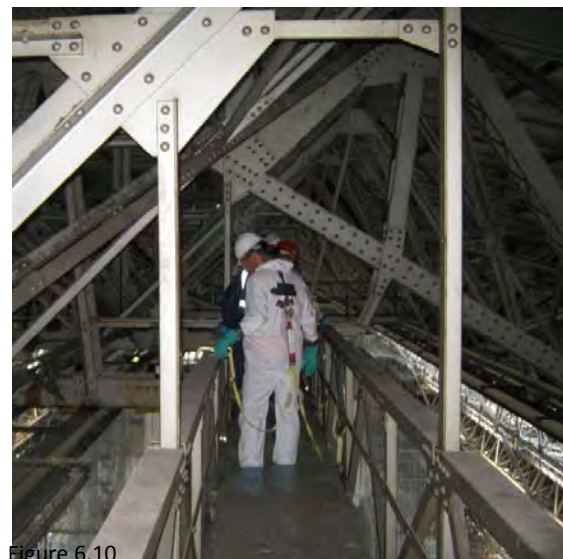

Figure 6.10

elevation. As noted above, by utilizing a low profile, lay-in grating system to re-floor the catwalk, a guardrail height increase of approximately 4" may be achieved. The configuration of the existing supporting angle may also serve as the code required toe plate. If additional height is required at the toe plate, a visually distinct steel plate extension can be attached to the edges of the lay-in grating sections.

If for future use the catwalks are accessed only by personnel with proper fall protection equipment and training, the improvements to the guardrail heights and toe plate addition would not be required as noted above.

6.B.7 Beacon and Obstruction Light Access

The beacon is a roof-mounted light attached to a raised metal platform, which is required due to the proximity to the adjacent runway. All future construction must maintain operation of the beacon, and access to it. A permanent source of power is included in the Rehab Plan in order to keep this light on. As discussed in the Condition Assessment, the Navy under the removal action of the hangar will provide access. As part of executing any of the potential options discussed in this Rehabilitation Plan, this access is required to be maintained and re-skinning the structure is required to be coordinated to provide ongoing access to fully working beacon lighting without interruption.

6.B.8 Elevator Replacement

The original building contained two small elevators, providing access from the main floor level to the upper levels of the hangar, stopping at catwalk level 7. Access to the remaining upper portions of the hangar occurs through a series of catwalks and stairways. The elevator cabs have been removed, and one cab salvaged. The components of this salvaged elevator are stored in the NASA History Department Storage Building at the Ames Research Center. The structure for the elevators includes steel primary structure as well as timber framing. This timber framing is being removed due to contaminants. The Rehabilitation Plan does not include re-installing the timber framing or the elevators. Future access to upper levels is figured to be required on such an infrequent basis, that alternative means is considered more viable. If future tenant use would require elevator access to upper portions of the hangar it would be the responsibility of the tenant to include this in their plans.

6.B.9 Hangar Door Component Replacement

As part of the re-skinning projects under Option A the hangar doors are to be repaired to bring them back to working order. One of the existing door motors has been removed on the north hangar door. Its current location is unknown. Ideally a new motor will be provided to match the visual look of the existing motors. The south hangar door motors are both in place and were last known to have operated in 2001. These motors shall be repaired and serviced in order to provide full operability of the doors. If the motors are beyond repair they shall be replaced to match the existing motors visually (one option would be to provide new motors within the existing motor housing).

In addition to servicing and repairing the motors the door trucks and tracks will require service and repair to ensure operability. As part of the Navy's removal action the filler boards are being removed from the tracks. These boards will require replacement to match the existing detail.

The top pivots of the hangar doors will also require service to bring them back to a workable status. One of the pivots is currently known to be leaking oil. All housings and components will require cleaning and miscellaneous repairs.

As part of the re-skinning project improvements are to be provided of the seals of the existing clam shell door detailing. The intent in doing so is to help minimize potential infiltration of moisture through the exterior envelope as discussed in section 8.0 Mechanical and Plumbing Systems. The most suitable solution for this is the addition of neoprene seals that can be applied on both the hangar exterior and the hangar clam shell doors that compress onto each other and provide a complete seal. This seal should be provided at the sides and top of the doors. At the bottom detailing shall be researched and proposed as part of the re-skinning project to create a sweep that will eliminate or largely minimize potential infiltration.

As part of the ongoing Navy removal actions all oil reservoirs will be drained and all components and mechanisms will be cleaned to the extent practical. Many of the mechanisms have shown signs of leaking oils (most trucks and both pivots points have been leaking) and will need to be repaired or replaced as part of the re-skinning projects. The Navy also intends to wrap the existing door motors to protect them from the elements. NASA and the Navy conducted a site visit on November 2, 2011 to further discuss and determine the responsibilities for these components.

6.B.10 Alternate Material Discussion

This Rehabilitation Plan has presented options analysis and general material discussions in the previous sections. The following sections include discussion of the Impacts to the Historic Resource of basic re-skinning and material selections. Although it may be ideal from a purely historic preservation perspective to replace all exterior skin materials "in kind" with custom manufactured wall panels and glazing, there are other alternatives that may closely approximate the visual appearances of the existing materials in a more cost effective alternative and with readily available materials. Some of these material alternatives have already been presented in the above sections. To follow is a complete list of the material alternatives considered in this study, together with pros and cons of each and a final recommendation on their use:

Siding Material Alternative: *Provide only a single metal panel profile on the hangar.* In lieu of covering the hangar with metal panels in two distinct profiles to match the original construction, provide a single metal panel profile over the entire hangar structure.

The general perception of the Hangar is of a single panel for the siding and roofing. Visually, it is difficult to tell the difference between the lower v-beam and the custom roof panels. The black color which was added to the roof panels makes the profile more difficult to distinguish than if it were the same color as the siding because shadow lines blend in with the dark color. Use of a panel which matches the original profile and color could look different than current perception.

Utilizing a V-beam panel to match the original panel for the siding is a logical choice. Not only would it match the existing profile, it would also match the original color (galvanized) and because the panel sizes will be the same as original, the original patterns and sightlines will be maintained. All of these factors are important due to the historic nature of the building, and the California State Historic Preservation Office will be looking at this closely.

Selection of the roofing panels is more difficult. Matching the original design will require a custom panel since the current profile is no longer a standard panel. This may add some cost, however this is not considered significant due to the volume of material required. Several manufacturers are capable of creating custom tooling to create the panel profile.

Advantages:

- Lower cost of materials and reduced risk of delay since no custom tooling required

Disadvantages:

- Does not exactly match the original construction. Public perception in not fully replacing the original siding design could be negative.
- California Historical Preservation Office approval at risk

Siding Material Alternative: *Off the shelf metal panel profiles.* Use off the shelf metal V-Beam panel profiles that are readily available and in common production by metal wall panel manufacturers in lieu of custom manufactured wall panels.

Advantages:

- Higher probability of positive reaction due to matching historic design.
- Lower cost of materials and reduced risk of delay since no custom tooling required
- Multiple suppliers capable of manufacture and delivery

Disadvantages:

- Roof panels will not match original. Use of roof panels that don't match original design could be perceived negatively.
- California Historical Preservation Office approval at risk if panels don't match existing.

Siding Material Alternative: *Panelization of metal wall panels.* In lieu of installing multiple individual panels to match the size of the existing panels produce larger panelized sections either off-site or in-site to reduce the installation labor of re-skinning the hangar.

Installing single, metal panels on a building the size of Hangar One is a laborious, time intensive task. Means of reducing the level of effort are, therefore, often considered to reduce the labor costs for installation. Modular panels are an alternative that may be possible on Hangar One, whereby metal panels are attached to a separate frame and lifted into place in a larger assembly. Careful detailing will be required to ensure the siding matches original appearances. The contractor that eventually completes the installation of the new siding must carefully scrutinize the panels to be installed to ensure the quality of construction. Using modular panels in the final construction contract documents should require mock ups for review and approval of all details, and full design details submitted to review by a preservation architect to ensure design is compatible with original design.

Advantages:

- Potentially shorter installation, or construction time
- Possible reduced construction costs

Disadvantages

- Added modular frame required for attaching to structural steel must be aligned perfectly to avoid altered sightlines
- Not all panel types are suitable for use in modular panels. Corrugations may not align properly, affecting visual impacts of the building.

- Temporary connections required for lifting panels may need removal after panels are secured, creating a difficult and time consuming effort

Roof Crown Material Alternative: *Replace the BUR with metal panels.* In lieu of providing a section of built-up roofing on the top crown of the hangar install metal panel roofing over the entire wall and roof portions of the hangar.

Replacing the existing narrow strip of built-up roofing with metal panels was considered in order to reduce the maintenance and replacement costs of the built-up roofing. Getting materials to the roof level for replacement is a difficult process limited to a few roofing contractors. Extending the roof panels to the ridge using current installation methods provides an opportunity to reduce those ongoing costs. Care is required in the detailing and substrate to prevent leaks due to the low slope near the top of the building.

Advantages:

- Less frequent and reduced maintenance cost
- Less frequent replacement costs.
- Single responsibility for weather-tightness of the building envelope by metal panel manufacturer (although it is possible that a BUR and metal wall panel might be provided by a single sub-contractor)

Disadvantages:

- Roof becomes nearly flat. High quality installation required for water-tightness

Windows Material Alternative: *Provide flat wired glass at all locations* – Provide flat, wired glass in all window locations in lieu of custom (or foreign manufactured) corrugated, wire glass to match the existing construction.

Advantages:

- Reduced costs
- Reduced risks of material breakage
- Reduced risk of missing product manufacturing cycle

Disadvantages:

- Does not match original design. Perception may be negative. Approval of State Historic Preservation office at risk.

The existing corrugated, wire glass windows are a unique, well known feature of Hangar One. These windows are a significant part of the historical nature of the building. Consideration of using flat wired glass was done due to the difficulty in finding manufacturers of corrugated glass to match existing. No American manufacturers were found that produced corrugated glazing to match the existing. One foreign manufacturer was discovered that produces corrugated glazing that matches the existing within a few millimeters. This manufacturer however, only produces the wire glass one time per year. The use of flat wire glass, which is readily available from multiple manufacturers, would eliminate the availability difficulties. Replacement of broken panels in the future would also be done more readily. With corrugated glass, it would be recommended to order multiple extra units at the time of original order, so that material was available for replacing broken units if that occurs..

Windows Material Alternative: *Provide fiberglass panels in lieu of corrugated glass windows .* Provide corrugated translucent fiberglass panels in lieu of corrugated, wire glass and the upper window bands.

Advantages:

- Reduced cost
- Readily available product for install and replacement.

Disadvantages:

- Constant yellowing of fiberglass. Regular replacement required. Significant visual impacts
- Doesn't match original design. Not likely approved by State Historic Preservation Office.

Alternatives for glazing have considered all known possible materials. Fiberglass was considered because of it's lightweight properties, market availability, and the fact it would be easier to replace broken units. It is not considered an acceptable product choice however for this historic building due to a natural tendency of yellowing, as well as the likelihood that the California SHPO office would not approve of this material.

Concealed Fasteners Material Alternative: *Concealed Fastener Metal Panel Attachment* – Provide a concealed fastening system for the exterior metal panels. It is possible that a concealed fastener panel system could be designed, engineered and manufactured for this re-skinning application. There are two potential solutions for this type of installation: a tongue and groove seam or panels with a bracket or batten bar on the back for attachment (refer to the Concealed Fastener Conceptual Details in section 12.0 Support Drawings). The vertical seams of the panels typically provide attachment of the panels to each other, thus making the tongue and groove condition would work well for vertical seams. The horizontal seams of the panels typically provide the locations for attachment to the hangar structure, thus making the batten attachment work well for horizontal seams. A custom metal panel system would have to be designed, engineered, tested and manufactured to hybridize these seam conditions. In either condition the j-clip fasteners would mechanically connect between the structural steel C channel and the batten bar at the horizontal joints. Final design and engineering of this type of custom system has not been included as part of this Rehabilitation Plan.

Some of the pros and cons for a concealed fastener panel system are:

Advantages:

- Concealed fasteners would eliminate the need for exposed neoprene washers, which may deteriorate over time and cause leaks in the siding
- Use of a concealed fastening system may allow for all installation access to occur from scaffolding mounted on the interior of the hangar

Disadvantages:

- Potential cost. This type of metal panel will likely require custom manufacturing
- Custom panels will require a high level of engineering and will not have been put through any standard material and/or performance testing
- The original construction and existing condition have exposed fasteners. There may be an impact to the review by the state historic preservation office
- Installation and design requirements as noted above

6.B.11 Floor Slab Rehabilitation Options

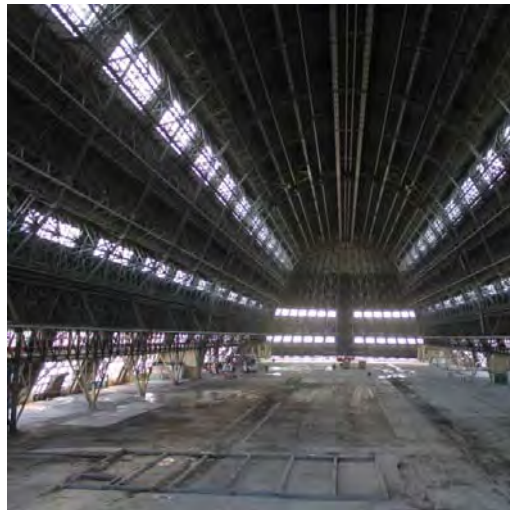

Figure 6.11

The existing hangar floor slab is less than ideally smooth. It is rough, and uneven in various locations that will make it an area of future modifications, depending on future tenants requirements. The floor slab also contains multiple locations of existing concrete curbs that served as foundations for previous interior construction that has since been removed from the facility as part of the Navy demolition contract. These curbs will require future removal to facilitate re-use of the interior of the hangar. There also are small areas of topping slabs that previously provided smooth floor slabs within various interior spaces. These topping slabs will likely need to be removed to meet future tenant needs. Additionally, the existing 8" deep hangar slab was originally designed for use with a 'lighter than air' aircraft. Because of this, the floor slab load capacity might not be suitable for heavy loading and traffic.

This potential capacity is discussed further in section 7.D.1 Floor

Slab. Floor slab repairs are included as alternatives in the detailed cost estimates, however this work would not be included until a tenant is identified and specific needs determined.

6.C Impacts to the Historic Resource

6.C.1 General Statements on Impacts to the Historic Resource and Building Significance

In 1994, Hangar One was listed on the National Register as a contributor to the United States Naval Air Station, Shenandoah Plaza Historic District. Individually, it has been determined eligible for listing on the National Register under Criterion A – Historic Patterns of Events and under Criterion C - Military and Historic Design/Construction categories, both at the national level of significance.¹ It is currently individually recognized as a Naval Historical Landmark and as a California Historic Civil Engineering Landmark by the San Francisco Section, American Society of Civil Engineers.²

The building's significance is directly attributed to its Streamline Moderne style, its design, construction, and contributions to the war efforts through the end of World War II. As such, its period of significance has been identified as 1932-1945.³ Based on this established period of significance, the intent is to rehabilitate the building to its original (c.1932) appearance. This entails returning the building to a monochromatic color scheme and restoring the windows to a uniform appearance across each level.

The current black-and-silver appearance of Hangar One reportedly developed as an attempt to correct an inherent flaw in the design of the building. Its size and materials create microclimates within the hangar that resulted in condensation at the ceiling. Recent analysis questions the effectiveness of the heat gain from the black coating in limited internal condensation. However, in spite of the original reason for the color

change, this change has acquired significance over time. Re-introduction of this significant change could be included as an option if such an aesthetic is beneficial to the project.

6.C.2 Overview of Mitigation Measure Development

According to the Navy/Marine Corp Installation Restoration Manual"

"The effects of an undertaking must be taken into account if historic or archaeological properties are found. If there is an adverse effect, the [Navy] will need to enter into consultation with the appropriate parties to resolve the adverse effects. The [Navy], the State Historic Preservation Officer, the [Advisory Council on Historic Preservation] ACHP, or other interested parties may agree on measures to avoid, reduce, or mitigate the adverse effects on historic properties or to accept such effects in the public interest. The Navy/Marine Corps must then submit written documentation as specified in 36 CFR 800.8(d) to the ACHP and request comment. The [Navy] must consider the ACHP's comments and notify the Council of its decision."

The Engineering Evaluation/Cost Analysis Revision 1 (EE/CA) concluded "all alternatives would have an effect on the historic character of Hangar One..."⁴ Therefore, this study included mitigation measures as part of the analysis that eventually resulted in selection of the remediation treatment currently being completed by the Navy (Alternative 10.) These mitigations for cultural resources included:⁵

- Level 1 Historic American Engineering Record (HAER) documentation
- Oral histories of individuals who worked in the hangar during different eras
- Creation of a virtual Hangar 1 interactive compact disk
- Inventory/catalogue of Hangar One collections contained in the Moffett Field Museum
- Preservation of the Hangar One man-cranes
- Coating the steel frame with a protective coating similar in color to the hangar's former siding.

These mitigations were developed by the Navy in consultation with the California Office of Historic Preservation (SHPO), the Advisory Council on Historic Preservation (ACHP) and local stakeholder groups as part of the Comprehensive Environmental Response, Compensation, and Liability Act (CERCLA) process.⁶

The last mitigation is particularly of relevance to this Rehabilitation Plan. The EE/CA goes on to state:

"Alternatives that remove the siding, decking, and roofing, but leave the underlying steel frame, will have the steel frame coated with protective coating colored to match the original hangar's former siding... Replacing the siding with a material similar in color and appearance to the original hangar siding to minimize the visual changes caused by the implementation of this alternative is also considered in the EE/CA"

With regards to selection of materials for residing the hangar, no further guidance was suggested.⁷ As a historic resource, work on the building should comply with the Secretary of the Interior's Standards. The Standards and Guidelines for Rehabilitation (Standards) have been used for comparison of the various

⁴ Engineering Evaluation/Cost Analysis Revision 1, July 20, 2008, 5-4.

⁵ Engineering Evaluation/Cost Analysis Revision 1, July 20, 2008, ES-5

⁶ Engineering Evaluation/Cost Analysis Revision 1, July 20, 2008, 4-5.

⁷ Action Memorandum, December 2008, Appendix B: Responsiveness Summary for Engineering Evaluation/Cost Analysis, Revision 1,1-55. The comments in this document were concerned with the removal of the siding as a remediation and did not provide any further guidance on appropriateness of any replacement materials.

¹ Page & Turnbull, *Hangar One, Moffett Field, California, Re-Use Guidelines*, August 24, 2001, 15-16

² Page & Turnbull, *Hangar One, Moffett Field, California, Re-Use Guidelines*, August 24, 2001, 13

³ Page & Turnbull, *Hangar One, Moffett Field, California, Re-Use Guidelines*, August 24, 2001, 16

construction options in this Rehabilitation Plan. They have informed the development of recommended materials for residing the structure – both siding and window materials. The result is a series of recommendations that provide options for re-skinning the building that respond to a wide range of project requirements, including compatibility with the Standards.

Final selection of specific materials should be done through further consultation with SHPO, ACHP, and local stakeholder groups based on the information presented in this document.

6.C.3 Secretary of Interior Standards for Rehabilitation from the National Park Service

*Rehabilitation is defined as the process of returning a property to a state of utility, through repair or alteration, which makes possible an efficient contemporary use while preserving those portions and features of the property which are significant to its historic, architectural, and cultural values.*⁸

As stated in the definition, the treatment "rehabilitation" assumes that at least some repair or alteration of the historic building will be needed in order to provide for an efficient contemporary use; however, these repairs and alterations must not damage or destroy materials, features or finishes that are important in defining the building's historic character.

The following are the Secretary of the Interior's Standards for Rehabilitation:

1. A property shall be used for its historic purpose or be placed in a new use that requires minimal change to the defining characteristics of the building and its site and environment.
2. The historic character of a property shall be retained and preserved. The removal of historic materials or alteration of features and spaces that characterize a property shall be avoided.
3. Each property shall be recognized as a physical record of its time, place, and use. Changes that create a false sense of historical development, such as adding conjectural features or architectural elements from other buildings, shall not be undertaken.
4. Most properties change over time; those changes that have acquired historic significance in their own right shall be retained and preserved.
5. Distinctive features, finishes, and construction techniques or examples of craftsmanship that characterize a property shall be preserved.
6. Deteriorated historic features shall be repaired rather than replaced. Where the severity of deterioration requires replacement of a distinctive feature, the new feature shall match the old in design, color, texture, and other visual qualities and, where possible, materials. Replacement of missing features shall be substantiated by documentary, physical, or pictorial evidence.
7. Chemical or physical treatments, such as sandblasting, that cause damage to historic materials shall not be used. The surface cleaning of structures, if appropriate, shall be undertaken using the gentlest means possible.
8. Significant archeological resources affected by a project shall be protected and preserved. If such resources must be disturbed, mitigation measures shall be undertaken.
9. New additions, exterior alterations, or related new construction shall not destroy historic materials that characterize the property. The new work shall be differentiated from the old and shall be compatible with the massing, size, scale, and architectural features to protect the historic integrity of the property and its environment.

⁸ Source: <http://www.nps.gov/history/hps/tps/standards/rehabilitation.htm>

10. New additions and adjacent or related new construction shall be undertaken in such a manner that if removed in the future, the essential form and integrity of the historic property and its environment would be unimpaired.

6.C.4 General Discussion of Replacement Material Suitability and Guidance Criteria

Understanding the historic resource and planning for its rehabilitation must involve consideration of impacts to the character defining features for the building. Both the Galbestos siding and the strips of windows have been identified as significant exterior features. Both will be impacted by the current removal action as both will be completely removed. Therefore selection of appropriate replacement materials is a critical component of the Rehabilitation Plan as a way to mitigate the potential impacts from removal of the exterior shell of the building.

6.C.4.1 Background

Hangar One was clad with Robertson Protected Metal panels in two different profiles. Originally developed in 1906, Robertson's invention of protected metal cladding evolved out of the company's revolutionary advances in metal coatings that protected the substrate from corrosion. Robertson Protected Metal – or RPM as it quickly became known – was soon accepted by designers and constructors because it allowed for the rapid construction of relatively lightweight steel skinned buildings with little building mass and minimal internal support, such as modern power stations or large aviation hangars.⁹ By 1932, when Hangar One was constructed, it was one of the most common building materials for hangars and large industrial buildings. However, the product's corrosion resistance is partially derived from the asbestos and PCBs used in its manufacture. As a result, the rehabilitation of Hangar One requires that all the exterior siding be removed to eliminate this source of environmental toxins.

The windows are the primary source of internal illumination. The large volume does not allow for efficient electric lighting, so daylight transmission was and is a critical aspect of making the hangar a usable space. For this reason, it is logical that the original glass, and therefore the replacement glass be as transparent as possible in order to emit daylight into the hangar. The original industrial context required thick panels of reinforced glass. At the time, the only way to get such a durable glass product was to manufacture it around a wire mesh. The types and shapes of the mesh changed over the years, as did the quality of glass found throughout Hangar One. Most of the changes are seen primarily on the first and second levels where flat wire glass was installed. There currently exists a myriad of glass types in different colors, opacities and translucence qualities. On the upper two levels, corrugated wire glass is typically found. This material is quite thick and in various states of disrepair. Because of the condition of original glazing and the amount of replacement glazing already in place, the current Rehabilitation Plan calls for all the glazing to be replaced to provide a more uniform appearance, such as existed when the building first opened.

Selecting viable replacement materials must take into consideration the aesthetics of Hangar One both close up and at a distance. Selection must also consider the structural implications of altering the weight or configuration of the over 650,000 square feet of cladding materials on the steel supporting framework. Material longevity, maintenance, cost and availability all play a part in the final material selection. For the purposes of this discussion, the considerations are limited to historically appropriate materials that are compliant with the Secretary of the Interior's Standards for Rehabilitation.

⁹ *Format 6: A newsletter from HH Robertson Asia/Pacific* (date unknown) at <http://www.robertson.com.hk/format6.pdf> (accessed 8.26.2011).

6.C.4.2 Selection Methodology

A review of the many documents that have been generated since this project was first considered in the 1990s did not establish any clear guidelines for selection of a historically appropriate siding replacement material. Most note that any materials should be compliant with the Secretary of the Interior's Standards, but do not go further to illustrate what the characteristics of these replacement materials might be. Therefore, the following guidelines have been developed from established preservation methodologies of replace in-kind, understanding the character-defining features of the building and the materials being considered, and looking at options that are both compatible and functional. For all of the different types of cladding materials considered here, the first option is the preferred option. Subsequent options are presented in a prioritized order from least impactful, to more impactful, to most impactful, and to not recommended.

6.C.4.3 Panel Profile One – V-Beam

The lower siding profile is a series of V-shaped corrugations with flattened points at the trough and peak of the shape. Over time, as different coats of paint and sealants have been applied, this profile has been softened into an approximate sinusoidal shape. Up until now, all studies and reports related to the reuse of the hangar have assumed the siding was sinusoidal in shape. Based on current observations and measurements, in combination with closer examination of the original construction drawings, this siding has been confirmed as having a "V-Beam" profile that is attached to the substructure with an exposed fastener.

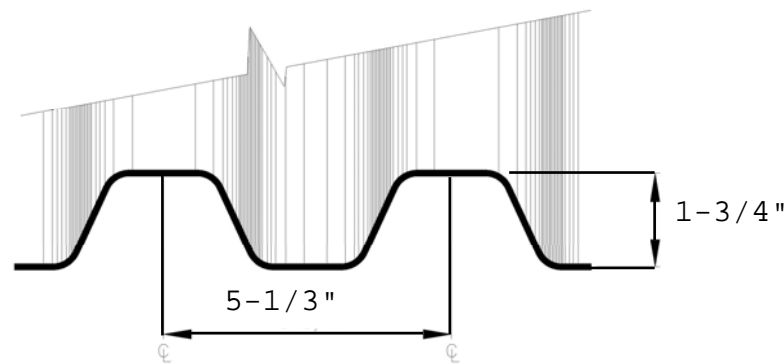

Figure 6.12

Design Characteristics of the existing material:

- Type: Robertson Protected Metal (RPM) wall cladding
- Thickness: 20 gauge steel
- Design: V-beam corrugation
- Original finish: matte silver finish (suspected¹⁰)
- Current finish: painted silver finish (current)
- Overall corrugated amplitude: 1-3/4"
- Period: 5-1/4"
- Dimensions: approximately 30" wide by 9-feet long (some panel heights vary on the original construction, refer to the AECOM as-built drawings sheet M001-1100-A3.04)

¹⁰ Additional research is required to more precisely determine the nature of the original finish.

- Fasteners: Exposed bolts connected to the structure with steel clips

Alternative 1- Least Impactful

Replace with 20 gauge, corrugated metal sheeting that matches the existing in profile (v-beam), size, amplitude, color, texture, finish depth, and exposed fasteners. The view from the interior and exterior of the hangar should re-establish the original aesthetic.

a. Sub-options include

- i. Use a lighter gauge metal that still provides the same durability
- ii. Use of 20 gauge metal panels with the existing metal profile, amplitude, shape, color, texture and finish depth and is installed in larger panels that are scored to mimic the current panel seam placement

Pros

- This option retains the current aesthetic and follows the Secretary of the Interior's Standards for Rehabilitation, Standard 6 for material replacement. From a historic resource perspective, this is the least impactful option because it results in the fewest changes in the historic appearance of the building and most accurately represents the building's condition during its period of significance.
- A matching material is readily available.
- The existing structural system is set up to accept this type of material. No modifications to installation methods would be required, although they could be simplified through use of pre-fabricated panels (sub-option ii).

Cons

- Increased cost and potential manufacturing times – Off the shelf panels are not available to meet the custom profile. Therefore, there will be a cost associated with manufacturing a custom panel

Alternative 2 – More Impactful

Replace with a corrugated metal sheet that a sinusoidal profile that matches the existing in period, color, texture, finish depth, and amplitude. This would approximately match the current appearance of the original siding after being coated with many layers of paint and protective finishes over the last 79 years.

a. Sub-options include

- i. Use a lighter gauge metal that still provides the same durability
- ii. Use of 20 gauge metal panels with a corrugated metal sheet that matches the existing in period, color, texture, finish depth, and amplitude, but has a sinusoidal profile and is installed in larger panels that are scored to mimic the current panel seam placement

Pros

- This option approximates the current, worn-materials aesthetic after many years of being painted and coated with sealers. While it does not match the original material in its original condition, it would match the current appearance of the historic material. As such, it is moderately compliant with the Secretary of the Interior's Standards for Rehabilitation, Standard 6 for material replacement. Overall, the average person would see little difference between the building prior to removal action and the building after installation of this siding option.
- The existing structural system is set up to accept this type of material. No modifications to installation methods would be required, although they could be simplified through use of pre-fabricated panels (sub-option ii).

Cons

- Use of a substitute corrugation pattern diminishes the overall integrity of the building's design. It presents a version of the building that may look similar, but does not represent the true appearance of the building over the course of its existence. It presents a potential false sense of the characteristics of the building's shell during its period of significance.
- Corrugated sinusoidal material with the same period, color, texture, finish depth and amplitude will require custom fabrication.
- Increased cost and potential manufacturing times – Off the shelf panels are not available to meet the custom profile. Therefore, there will be a cost associated with manufacturing a custom panel

Alternative 3 – Most Impactful

Replace with a corrugated metal sheet that matches the existing in period, color, texture and finish depth, but is sinusoidal in profile and has an amplitude that is 1-3/8" or greater (maximum 1/2" variance from the current.)

a. Sub-options include

- i. Use a lighter gauge metal that still provides the same durability
- ii. Use of 20 gauge metal panels with a corrugated metal sheet that matches the existing in period, color, texture and finish depth, but is sinusoidal in profile and has an amplitude that is 1-3/8" or greater (maximum 1/2" variance from the current) and is installed in larger panels that are scored to mimic the current panel seam placement

Pros

- This option provides a sense of the current, worn-materials aesthetic after many years of being painted and coated with sealers. It does not match the original material in its original condition, and approximates the current appearance of the historic material. As such, it is marginally compliant with the Secretary of the Interior's Standards for Rehabilitation, Standard 6 for material replacement.
- The existing structural system is set up to accept this type of material. No modifications to installation methods would be required, although they could be simplified through use of pre-fabricated panels (sub-option ii).

Cons

- Use of a substitute corrugation pattern that marginally approximates the current appearance of the building diminishes the overall integrity of the building's design to a greater degree than the first two options. It presents a version of the building that has the same general appearance, but does not truly represent the building over the course of its existence. It presents a potential false sense of the characteristics of the building's shell during its period of significance.
- This material may start to alter the appearance of the building to a point that is noticeable by individuals familiar with it. The shadow lines and visual texture created by the shallower amplitude will differ from both the original and the current appearances. The building may appear to have a flatter finish.
- Corrugated sinusoidal material with the same period, color, texture, finish depth slightly less deep than existing and amplitude will require custom fabrication. Therefore, there will be increased manufacturing cost

Not Recommended:

Varying the period of corrugation – This is not recommended because the building would take on a much flatter visual appearance. It will start to look more like a large Quonset Hut rather than an industrial aircraft

hangar. This change in appearance would not be compliant with the Standards.

Varying both period and amplitude of corrugation – This option would further alter the visual qualities of the building's siding to a point that may be distinguishable by individuals familiar with the building. As seen from a distance, this difference would likely be apparent if compared to the original appearance. This change in appearance would not be compliant with the Standards.

Reducing the depth to less than 1" - This option would further alter the visual qualities of the building's siding to a point that may be distinguishable by individuals familiar with the building. As seen from a distance, this difference would likely be apparent if compared to the original appearance. This change in appearance would not be compliant with the Standards.

Note: Variance in the amplitude of the V-Beam corrugation should be tested visually to verify that the parameters given above remain applicable at the given heights along the building. These parameters are based on professional assumptions and are not based on field-testing of the resulting aesthetics.

6.C.4.4 Panel Profile Two – Mansard

The metal panel profile changes shape and size above an elevation of approximately 132 feet -6 inches from the V-Beam profile to the profile shown below. This second panel profile covers the majority of the hangar roof with the exception of the crown, which is covered with a built-up roofing material.

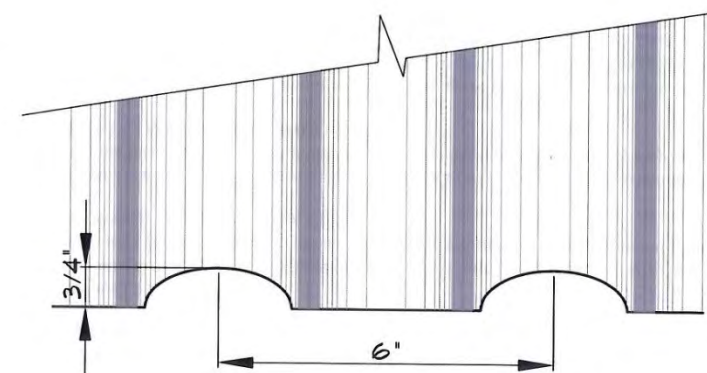

Figure 6.13

Design Characteristics of the existing material:

- Type: Robertson Protected Metal (RPM) wall cladding
- Thickness: 20 gauge
- Design: semi-circular
- Original finish: matte silver finish (suspected¹¹)
- Current finish: painted black finish
- Overall amplitude: 3/4"
- Period: 6"
- Dimensions: approximately 30 inches wide by 9-feet long (some panel heights vary on the original

¹¹ Additional research is required to more precisely determine the nature of the original finish.

construction, refer to the AECOM as-built drawings sheet M001-1100-A3.04)

This siding is installed from the built up flat roof down to a point approximately 132 feet above ground level. The upper siding is so far above the ground that its detail is not readily observable from any angle, other than the fact it is a profiled metal. While a difference in siding types is evident from the ground, it is the color difference that is more striking than the corrugation patterns. These recommendations have been developed assuming that the upper siding/roofing panels will be the same color as the lower siding to return the building to its c.1932 appearance. Field verification through mock-ups is recommended to establish the visual qualities of the panel variations as part of the intended monochromatic rehabilitation plan.

Alternative 1 – Least Impactful

Replace with 20 gauge, corrugated metal sheeting that matches the existing in profile, size, amplitude, original color, texture and finish depth. The view from the interior and exterior of the hangar should re-establish the original aesthetic, including use of wood planks (the existing material), or a visually compatible material to establish a “flat” interior surface.

a. Sub-options include

- i.* Use a lighter gauge metal that still provides the same durability
- ii.* Use of 20 gauge metal siding/roofing panels with the existing metal profile, amplitude, shape, original color, texture and finish depth and is installed with larger panels that are scored to mimic the current panel seam placement

Pros

- This option retains the current aesthetic and follows the Secretary of the Interior’s Standards for Rehabilitation, Standard 6 for material replacement. From a historic resource perspective, this is the preferred option because it results in the fewest changes in the historic appearance of the building and most accurately represents the building’s condition during its period of significance.
- The existing structural system is set up to accept this type of material. No modifications to installation methods would be required, although they could be simplified through use of pre-fabricated panels (sub-option ii).

Cons

- Increased cost and potential manufacturing times – Off the shelf panels are not available to meet the custom profile. Therefore, there will be a cost associated with manufacturing a custom panel

Alternative 2 – More Impactful

Replace with a corrugated metal sheet panel that is sinusoidal in profile but retains an amplitude of ¾ inch and a period of 6 inches.

a. Sub-options include

- i.* Use a lighter gauge metal that still provides the same durability
- ii.* Use of 20 gauge metal panels with a corrugated metal sheet that is sinusoidal in profile but retains an amplitude of ¾ inches and a period of 6 inches, and matches the existing in color, texture and finish depth and is installed in larger panels that are scored to mimic the current panel seam placement
- iii.* Use an alternate material on the interior to achieve similar appearance to timber deck.

Pros

- This option provides a sense of the current, worn-materials aesthetic after many years of being painted and coated with sealers. It does not match the original material in its original condition, and approximates the current appearance of the historic material with a different corrugation pattern. However, as viewed from the ground, the difference in corrugation patterns would be almost undetectable. While it does not match the original material in its original condition, it would approximate the current appearance of the historic material. As such, it is moderately compliant the Secretary of the Interior’s Standards for Rehabilitation, Standard 6 for material replacement. Overall, the average person would see little difference between the building prior to removal action and the building after installation of this siding option.
- This option retains two different siding profiles on the building.
- The existing structural system is set up to accept this type of material. No modifications to installation methods would be required, although they could be simplified through use of pre-fabricated panels (sub-option ii).

Cons

- Use of a substitute corrugation pattern diminishes the overall integrity of the building’s design. It presents a version of the building that may look similar, but does not represent the true appearance of the building over the course of its existence. It presents a false sense of the characteristics of the building’s shell during its period of significance.
- Corrugated sinusoidal material with the same period, color, texture, finish depth and amplitude may require custom fabrication.

Alternative 3 – Most Impactful

Replace with a corrugated metal sheet that matches the lower paneling.

a. Sub-options include

- i.* Use a lighter gauge metal that still provides the same durability
- ii.* Use of 20 gauge metal panels with a corrugated metal sheet that is sinusoidal in profile and matches the lower paneling in color, texture and finish depth and is installed in larger panels that are scored to mimic the current panel seam placement

Pros

- This option provides a sense of the current, worn-materials aesthetic after many years of being painted and coated with sealers. It does not match the original material in its original condition, and approximates the current appearance of the historic material. As such, it is marginally compliant the Secretary of the Interior’s Standards for Rehabilitation, Standard 6 for material replacement.
- The existing structural system is set up to accept this type of material. No modifications to installation methods would be required, although they could be simplified through use of pre-fabricated panels (sub-option ii).
- If the lower section of the building is also clad with the same material, there may be cost savings through a single production run, as opposed to producing two different custom products.

Cons

- Use of a substitute corrugation pattern diminishes the overall integrity of the building’s design. It presents a version of the building that may look similar, but does not represent the true appearance of the building over the course of its existence. While it may approximate the current appearance, in

reality it does not represent any material that was historically attached to the hangar. It presents a false sense of the characteristics of the building's shell during its period of significance.

- This would establish a uniform siding over the entire building, a condition that did not historically exist and may create a false sense of historical development.
- Corrugated sinusoidal or V-Beam material with the same period, color, texture, finish depth and amplitude may require custom fabrication, which would potentially increase cost and manufacturing times.

Not Recommended

Replacement with a new corrugated pattern not currently found on the hangar – This analysis is based on the facts that two different profiles currently exist and that over time, they have come to closely resemble each other as their profiles have been smoothed out by subsequent coating layers. The actual appearance is that of a sinusoidal wave even though there are two different profiles in reality. This is especially true when viewed from the ground, nearly 130 feet away from the material. Pushing this variance too far by introducing material profiles beyond these three choices does not represent the historical appearance of the building at any point in its history. Therefore this is not a recommended option.

Note: Variance in the amplitude of the corrugated wave should be tested visually to verify that the parameters given above remain applicable at the given heights along the building. These parameters are based on professional assumptions and are not based on field-testing of the resulting aesthetics.

Additional Considerations

Any re-introduction of the black coloring should take into consideration the aesthetic characteristics of the existing coating. It should match the existing in surface texture, reflectivity, and location of application. If a coating is reintroduced, it should be the minimum thickness necessary to perform its function and should remain colorfast of the life of the application.



Figure 6.14

6.C.4.5 Flat, Wired Glass

Design Characteristics of the existing material:

- Location: flat wire glass at Levels 1 and 2 generally
- Wire matrix: different wire shapes present, further investigation is needed to determine exactly which ones are the original wire pattern and which ones are later replacements
- Transparency: ranges from clear to translucent depending on the type of replacement glazing used
- Opacity: clear (originally), yellow and purple variations have developed over time depending on the types of glass used. New glazing to be clear.
- Framing: steel frames and mullions, painted
- Configuration: Centered in 72 foot bays, 48 feet wide

Many lites have been replaced over the years with a variety of similar glazing based on local availability. A complete replacement process will provide new opportunities to procure glazing of a consistent style and pattern. Extra panels should be acquired to replace broken panels in the future. Wire patterns vary as does the surface treatments of the lites. Some have fine ribbing. These recommendations assume that all

glazed surfaces will be returned to a uniform appearance throughout Levels 1 and 2. The Navy is removing the existing T-shaped steel mullions as part of the removal action. New steel frames and mullions will be required.

Alternative 1 – Least Impactful

Replace in kind. Replacements should match the original in wire pattern, thickness, transparency and configuration.

Pros

- This option retains the original aesthetic and follows the Secretary of the Interior's Standards for Rehabilitation, Standard 6 for material replacement. From a historic resource perspective, this is the preferred option because it results in the fewest changes in the historic appearance of the building and most accurately represents the building's condition during its period of significance.
- The existing structural system is set up to accept this type of material. No modifications to installation methods would be required.
- This material is readily available.

Cons

- From a preservation perspective there are no cons to this alternative

Alternative 2 – More Impactful

Replace with a similar glazing that matches the original in thickness, transparency and configuration. Wire pattern should be approximately the same size as the original and vary only in shape. For example replacing hex wire or chicken wire with a diamond pattern of a similar scale.

Pros

- This option very closely approximates the original aesthetic and follows the Secretary of the Interior's Standards for Rehabilitation, Standard 6 for material replacement. The wire pattern is indicative of the date of the material's manufacture, but it is not a critical character-defining feature of the glass itself. It is more important to have wire in the glass, than to have a specific wire pattern within the glass.
- The existing structural system is set up to accept this type of material. No modifications to installation methods would be required.
- This material is readily available.

Cons

- Use of a different, more modern wire pattern may present a misleading sense of the original design aesthetic.

Not Recommended

Replacing with non-wire glass – Non-wire glass was not typically installed in industrial settings. Installing flat plate glass now reduces the industrial appearance of the hangar. This was a working military building for over 80 years and its significance is closely tied to its design as such. Introducing a non-industrial glass product is not in keeping with this design aesthetic and is not recommended.

Varying transparency or opacity – The quality of the light entering this large space is an important aspect of the original design. The difficulty in artificially illuminating such a space meant that natural light was critical to the operation of the hangar. Therefore, the choice of clear, untinted glass was an important design choice that should be maintained. Changes in transparency or opacity of the lower windows would impact the nature of the light at the ground floor within the interior. Such alterations are not recommended as they are in direct contradiction to the original design intent.

Altering the size of the individual lites. – Fenestration patterns were highly regular when the building was first constructed. Since the building's appearance will largely represent that during the period of significance, as it was originally constructed, regular fenestration patterns should be used in the rehabilitation. Changes have occurred over the years that have marred this portion of the design to the detriment of the building's overall appearance. Further modifications are not recommended as they would continue to degrade the original Streamline Moderne design.

6.C.4.6 Corrugated, Wired Glass

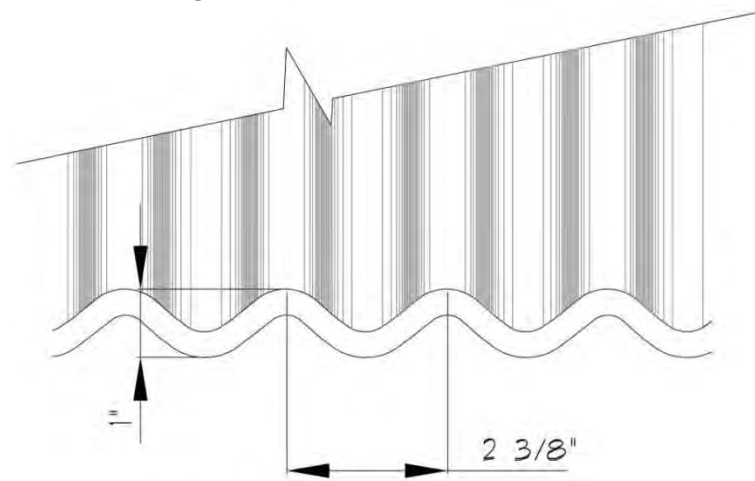

Existing 1/2 " thick Historic Corrugated Window

Figure 6.15

Design Characteristics of the existing material:

- Location: corrugated wire glass at Levels 3 and 4 generally
- Framing: steel frames and mullions
- Configuration: Centered in 72 foot bays, 48 feet wide

These recommendations assume that all glazed surfaces will be returned to a uniform appearance throughout Levels 3 and 4. It is also assumed that existing steel frames will be repaired and rehabilitated to accept the new glazing as necessary, as noted above.

Alternative 1 – Least Impactful

Replace in kind. Replacements should match the original in corrugation periods and depth, wire pattern, thickness, transparency and configuration.

Pros

- This option retains the original aesthetic and follows the Secretary of the Interior's Standards for Rehabilitation, Standard 6 for material replacement. From a historic resource perspective, this is the preferred option because it results in the fewest changes in the historic appearance of the building and most accurately represents the building's condition during its period of significance.
- The existing structural system is set up to accept this type of material. No modifications to installation methods would be required.

Cons

- This material would require custom fabrication, which would increase costs and potential manufacturing times
- This custom material is not readily available from multiple sources in the United States. There are sources outside of the U.S. that custom manufacture this material. Compliance with the Buy American Act would need to be met

Alternative 2 – More Impactful

Replace with non-wire corrugated glass that matches the original in corrugation periods and depth, thickness, transparency and configuration. Local building codes must be checked to confirm whether glazing must be strengthened (tempered.)

Pros

- This option very closely approximates the original aesthetic and follows the Secretary of the Interior's Standards for Rehabilitation, Standard 6 for material replacement. The wire pattern is indicative of the date of the material's manufacture, but it is not a critical character-defining feature of the glass itself. It is more important to have corrugated glass than for it to contain wire as the wire pattern is not visible from the ground.
- The existing structural system is set up to accept this type of material. No modifications to installation methods would be required.

Cons

- Use of a corrugated glass with no wire pattern may present a misleading sense of the original design aesthetic. Increased cost and potential manufacturing times – Off the shelf glazing without wire is not available to meet the custom profile. Therefore, there would be impacts to cost, availability and production times for this type of custom manufactured material

Alternative 3 – More Impactful

Replace with non-wire corrugated glass that approximates the original in corrugation periods and depth, thickness, transparency and configuration. Local building codes must be checked to confirm whether glazing must be strengthened (tempered.)

Pros

- This option very closely approximates the original aesthetic and follows the Secretary of the Interior's Standards for Rehabilitation, Standard 6 for material replacement. The wire pattern is indicative of the

date of the material's manufacture, but it is not a critical character-defining feature of the glass itself. It is more important to have corrugated glass than for it to contain wire as the wire pattern is not visible from the ground.

- The existing structural system is set up to accept this type of material. No modifications to installation methods would be required.
- May provide a greater range of possible material options for selection and comparison.

Cons

- Use of a corrugated glass with no wire pattern may present a misleading sense of the original design aesthetic.
- Although this material might be less costly than the more historic material it would still require custom fabrication which would carry with it potential added costs and timelines

Alternative 4 – Most Impactful

Replace with fiberglass panels in lieu of glass. Replacement fiberglass panels should approximate the original in corrugation periods and depth, thickness, and configuration. Fiberglass panels may be less costly. They would provide less daylight and appear different than original glazing. Due to height of levels 3 and 4, this may be acceptable.

Pros

- This option marginally approximates the original aesthetic and is marginally compliant the Secretary of the Interior's Standards for Rehabilitation, Standard 6 for material replacement. The wire pattern is indicative of the date of the material's manufacture, but it is not a critical character-defining feature of the glass itself. It is more important to have a corrugated material than for it to contain wire as the wire pattern is not visible from the ground.
- The existing structural system is set up to accept this type of material. No modifications to installation methods would be required.
- This material is readily available.
- This option is less costly in terms of the initial project.

Cons

- Over time, this material will discolor and translucency may decrease. It's anticipated lifespan is 5-10 years, after which it will require replacement. They are at a great height that may require specialized equipment to enable replacement.
- Over time, the aesthetic differences between this material and glass will become more apparent. This is true even as viewed from the ground or at a distance.
- The reflectivity of this material differs from glass. The difference may be apparent from a distance where the upper (Levels 3 and 4) and lower (Levels 1 and 2) rows of glazing are viewed together.

Alternative 5 – Most Impactful

Replace with flat glass that is altered to approximate the opacity and transparency as viewed from below. This may involve tinting the glass or altering the surface texture to approximate the appearance of the corrugated glass as viewed from an obtuse angle (from the ground.)

Pros

- This option marginally approximates the original aesthetic and is marginally compliant the Secretary of the Interior's Standards for Rehabilitation, Standard 6 for material replacement. The reflectivity of the original material, as well as the light quality entering the building from the upper levels would remain the same.
- The existing structural system is set up to accept this type of material. No modifications to installation methods would be required.
- This material is readily available.

Cons

- The corrugation is an important part of the character defining features of the material, and of the building. This option would remove original material and replace it with a version of the same material that differs significantly in appearance. Even from the ground and at great distances, this difference will be obvious.
- Use of a non-corrugated wire glass may present a misleading sense of the original design aesthetic.

Not Recommended

Replacement with clear flat glass - This option not only removes the corrugation characteristic of the glazing, but also changes the industrial wire glass with a more commercial type of the material. This varies too far from the original design aesthetic and is not compliant with the Secretary of the Interior's Standards for Rehabilitation.

Replace with translucent panels in lieu of glass. - Translucent panels may be less costly but they have a limited lifespan and a much different aesthetic than glass. The difference in texture, reflectivity and color would be readily apparent from the ground or at a distance. The quality of the light transmitted to the interior spaces would also vary significantly. As such this choice is not compliant with the Secretary of the Interior's Standards for Rehabilitation.

6.C.5 Other Aesthetic Considerations

Any replacement materials will be newly manufactured, and therefore be free of any patina. The building has changed over the years and this included application of color, coatings, weathering of materials, altering glass patterns, etc. The result is the current building aesthetic. Because the rehabilitation plan currently includes returning the building to its original exterior appearance with all silver siding and uniform windows, there will be a marked difference in the final aesthetic compared to existing conditions (prior to siding/window removal). It will be monochromatic and look newly constructed. While historically appropriate, it may require some thought as to how to lessen the stark contrast between the current building and the proposed rehabilitated structure. The preferred methodology is to allow the new material to develop a natural patina over time. However, if artificially weathering or custom coloring siding to more closely mimic the current aesthetic is desired, further study and discussion is necessary to determine an appropriate treatment that does not overly diminish the life expectancy of the new cladding.

6.D Steel Coatings

By the time a re-skinning project begins on the hangar a protective coating will cover the entire remaining steel structure as provided under the U.S. Navy's current removal action. The product being installed is Carbomastic 15 as manufactured by Carboline (this product and its application are discussed fully as part

of the Condition Assessment report). This protective coating is intended to cover the lead primer and any PCB contaminants that occur on the steel structural frame and provides a weather resistant, non-combustible coating. The coating manufacturer will be providing a 12 year warranty for the application under the Navy's removal action with 2% degradation. The manufacturer recommends that the coating be inspected every 3 years with touch-ups as necessary. CH2M Hill recommends that inspections occur annually with touch-up as necessary. Following the 12 year warranty period there may be a need for fully re-coating the structure. This will need to be determined based on the coating condition and the periodic inspections that will occur.

6.D.1 Attachment to Structural Steel

The re-skinning efforts associated with Option A and as previously discussed recommend utilizing a similar attachment system of the metal panels to the structural frame system as the existing design and construction. This utilizes carriage bolts with neoprene washers and clips that attach to the c-channel substructure without penetrating the steel member. Any re-skinning efforts whether using similar attachment methods or by using self tapping screw attachment to the existing structure will require that the coatings on the existing structure be repaired and touched up to ensure their protective qualities are maintained. If screws are installed into the steel structure, installers could be exposed to hazardous materials unless strict, comprehensive installation means are developed to mitigate exposure.

As part of Options B, C and D, structural upgrades may be provided to the existing steel frame systems to align with current code requirements and historic preservation considerations. This might require the modification and/or addition of new steel members to supplement the structural capacities of the existing members. These modifications/additions will likely cause damage to the existing coatings that will also require that they be repaired and touched up to ensure that the protective qualities are maintained and that proper comprehensive installation means are developed to mitigate exposure to those working on the installation.

A qualified coating specialist and the coating manufacturer's representatives will need to be included at the site inspections to not invalidate the 12-year warranty provided through the Navy removal action.

6.D.2 Impacts to Coatings

Following the addition of a new exterior skin system and possible structural code upgrades, the coatings on the existing steel structure and the resulting touch up the coating system will be protected from weather and UV exposure. This will allow for the life expectancy of the coatings to be extended beyond the durations noted above when exposed. After the re-skinning of the building it is reasonable to expect that the coating could last greater 20 years from time of application, depending on the duration of exposure of the coating prior to re-skinning. The coatings will require periodic inspection to determine whether touch-up or re-coating is required as recommended by the coating manufacturer. Brief inspection of the coatings should occur every five years with a more detailed inspection every 10 years. It is recommended that these periodic inspections be conducted by a National Association of Corrosion Engineers (NACE) certified coating inspector Level One.

7.0 Structural

To meet current codes, Hangar One may need several structural retrofits or upgrades and geotechnical remediation to resume use as described in options B through E. Option A requires no structural retrofits or

geotechnical remediation, but the risk to the structure is higher than in options B through E. A structural analysis of the existing steel members has been performed and identifies structural members which need retrofitting per ASCE 41-06. Miscellaneous structural items (e.g. trench grating and vault covers) were also identified for repair or replacement during a site visit and during review of existing reports. These are identified in the condition assessment portion of the report and further discussed in the following sections.

The structural analysis and evaluation of the building is based on soil site class D forces and no appreciable differential settlement due to liquefaction. The geotechnical portion of the report, however, identifies the possibility of soil liquefaction and therefore requires soil remediation to meet the site class D forces. Any soil remediation design and future geotechnical investigations need to take into account the contaminated groundwater at the site and must be approved by NASA to ensure that the contamination is not spread or migrated into areas that are currently not contaminated. The soil remediation and future geotechnical investigations must also not interfere with the Navy's remedial measures to clean up the ground water contamination and must take into account the constraints in the USEPA MEW Study Area Record of Decision Amendment for the Vapor Intrusion Pathway. The building may be alternately evaluated with an additional non-linear structural analysis based on additional site specific geotechnical analysis, which may result in both reduced expected settlements and amplified accelerations. The non-linear analysis method may be included as a value engineering (VE) option for the final design which may reduce the amount of steel needing retrofitting as well as reducing the amount of required soil remediation. The approach used in this report is intended to meet current building codes and standards; however it does not include all possible analysis methods. Based on the information available at the time of this study, the approach used in the geotechnical analysis portion of this report is conservative with regards to the settlement potential in order to capture the maximum probable required soil and steel mitigation.

7.A Impacts to the Historic Resource

The proposed structural upgrades under Option B are limited to augmentation of the current structural members, rather than the introduction of entirely new structural systems. The proposed changes are to approximately 163 individual members out of an estimated total of 20,000 structural members. This amounts to alterations to approximately 0.8% of the entire structural framework of the building. Given the immense size of the building, the relatively small size of the new additions and the distances from which these alterations may be viewed on the building interior, the average person will not be able to detect any changes to the appearance of the structure.

The proposed connections show either welded components or bolted components. One of the aspects of the Standards for Rehabilitation is the idea that reversible changes are preferred over non-reversible changes (Rehabilitation Standard 10). There is some historical impact from the welded connections as they are non-reversible alterations. *Bolted connections should be used whenever possible.*

Overall, the number of changes with respect to the entire system, the size of the individual proposed additions, and the possibility for reversible solutions result in proposed structural upgrades to the building that have a very low impact on the historic resource.

7.B Structural Analysis and Retrofit Requirements

The structural analysis methodology, design codes, and applied loads are discussed in Section 4.0 This section identifies those items which will require retrofitting to meet the requirements of the current code.

The following rehabilitation and re-use options are discussed in depth in Section 6.A. This section describes the structural implications of each option.

The hangar is of an antiquated design, and as such, cannot be retrofitted to fully meet the requirements of the current California Building Code, outside of the California Historic Building Code. The recommended retrofits increase the seismic performance of the building and meet the requirements of the California Historic Building Code and as such the California Building Code for Historic buildings. In the retrofit the A7 structural steel 30 ksi per ASCE based on the period of construction of the Hangar 1 and did not use the 46 ksi steel. However if the silicon steel is used for the chord members in the analysis, they may not be overstressed and will not require the retrofit proposed. This will reduce the total quantity of steel by about 2.5 tons.

7.B.1 Option A – Re-Skin and Maintain existing Hangar Occupancy

California Historic Building Code 2010 section 8-701.3 states that structural upgrade meeting the requirement of section 7-05 is required if “*structural upgrade or reconstruction is undertaken for qualified historical building.*” The re-skinning of this option is done because of hazardous material mitigation and does not qualify as reconstruction or structural upgrade; therefore it does not require the alternative structural regulation of section 705. California Building Code 2010 Section 3409A 1 states that, “The provision of this code relating to construction, repair, alteration, restoration and movement of the structure and change of occupancy shall not be mandatory where such buildings are judged by building official to not constitute a distinct life safety hazard.”

Also this option does not fall in the category of buildings to be upgraded per Executive Order (EO) 12941. A risk analysis has been performed but upgrade is not required.

Based on our review of the structure, it is apparent that the structure has a complete load path and there are no obvious members that are the weak links. According to California Historic Building Code 2010 section 8-705 *Where no distress is evident, and a complete load path is present, the structure may be assumed adequate by having withstood the test of time if anticipated dead and live loads will not exceed those historically present.*” Furthermore seismic evaluation of the building is performed per ASCE 41-6 and wind analysis per ASCE 7-05 and it was found not to be in any imminent danger considering non-liquefiable soils. However, for Option A, we are not considering soil remediation, and the soils will still be classified as liquefiable. The liquefaction of the soil during the design earthquake may cause:

- Excessive settlements of the foundation which could result in overstressing the piles and may cause pile failure.
- The settlement of the foundation will cause significant added force on the steel members resulting in yielding of structural steel causing redistribution of the forces to adjacent members and thus continuing yielding of more members and eventually causing progressive failure of the structural elements of the building. This may result in partial or full collapse of the building
- Excessive settlement of the slab on grade

- Failure of the tie beams that tie the main arches together. The failure of the ties will put significant lateral force on the pile foundation that further impacts the stability of the main arches.
- The settlement may impact most of the utilities serving the Hangar
- It will cause damage to the door/track system

In order to evaluate the effect of the settlement, the 3-D model for the middle section was analyzed applying an educated guess on the differential settlement to alternate foundations and the applied seismic equivalent static forces for site class D to evaluate the applied Demand Capacity Ratio (DCR) on the members. There is considerable discussion regarding the simultaneous application of the seismic forces and the settlement due to liquefaction. The actual forces in the existing, liquefiable soil case will be higher than those for the site class D used for the analysis. The force to be considered depends on a number of factors and for the larger earthquake, the larger the period of time over which strong shaking acts, it is more likely that the forces and settlement could act concurrently. Therefore, without the required geotechnical analysis, it was a conservative number for settlement was assumed to evaluate the structure. The differential settlement case in this report is for comparison purposes only and was not used to determine the recommended retrofits. Any soil remediation design and future geotechnical investigations need to take into account the contaminated groundwater at the site and must be approved by NASA to ensure that the contamination is not spread or migrated into areas that are currently not contaminated. The soil remediation and future geotechnical investigations must also not interfere with the Navy’s remedial measures to clean up the ground water contamination and must take into account the constraints in the USEPA MEW Study Area Record of Decision Amendment for the Vapor Intrusion Pathway.

The 3-D graphic Figure 7.3 shows the performance comparison of the Hangar with and without the ground improvements based on the static procedure. There are significantly more members with very high DCR indicating yielding of more members that the seismic case without liquefaction. The members after yielding redistribute the loads, overloading other members, causing more members to yield, followed with the progressive failure of more members. This phenomenon cannot be modeled in the Linear Elastic analysis. Furthermore, the applied loads for the actual site class without mitigation will be significantly higher, and that could further accelerate the failure of more members, causing partial or full collapse of the building.

In summary, based on the differential settlement educated guess, without soil remediation, the liquefaction may cause significant damage to the building and may potentially cause partial or complete collapse. In such an event, the building will likely not be repairable. The building may be alternately evaluated with an additional non-linear structural analysis based on additional site specific geotechnical analysis, which may result in both reduced expected settlements and amplified accelerations. The non-linear analysis method may be included as a value engineering (VE) option for the final design which may reduce the amount of steel needing retrofitting as well as reducing the amount of required soil remediation. The approach used in this report is intended to meet current building codes and standards; however it does not include all possible analysis methods.

7.B.2 Option B - Re-Skin and Upgrades (Structural and Geotechnical) and re-Use as a Hangar to meet current California Historical Building Code

In Option B, the hangar will be considered for structural upgrades and geotechnical remediation. The Hangar will be in Occupancy Category II for wind analysis and wind loads are determined according to

ASCE 7 – 05. For seismic design the building is analyzed and retrofitted using the Basic Safety Objective as described in table below:

Rehabilitation Objective	Building Performance Level	Earthquake Hazard Level	Earthquake Return Period
1	Collapse Prevention (CP)	2% in 50 years	2,475 years
2	Life Safety (LS)	10% in 50 years	475 years

The performance expectations described in ASCE 41-06 for the Collapse Prevention performance level assume that, after an earthquake of a specified severity, the building structure may be on the verge of total or partial collapse. Substantial damage to the structure has occurred, potentially including significant degradation in the stiffness and strength of the lateral-force resisting system, large permanent lateral deformation of the structure and, to a limited extent, degradation of the vertical-load carrying capacity. All significant components of the gravity-load-resisting system should, however, continue to carry their gravity load demands. Significant risk of injury due to falling hazards from structural debris may exist. The structure may not be technically practical to repair and may not be safe for re-occupancy.

The performance expectations described in ASCE 41-06 for the Life Safety performance level assumes that, after the earthquake of a specified severity, some structural elements and components are severely damaged but without falling debris hazards, either within or outside the building. Some permanent building lateral drift may be present. Injuries may occur during the earthquake, but it is expected that the overall risk of life-threatening injury as a result of structural damage is low. It should be possible to repair the structure, but for economical reasons, it may not be practical. Repairs should be made to any damage prior to re-occupancy of the building.

Both the Collapse Prevention and Life Safety performance levels with their respective earthquake hazards were analyzed for the applied forces due to wind using ASCE 7-05 and seismic forces per ASCE 41-06. The lateral forces are reduced to 75% per California Historic building Code.

Based on the acceptability criteria in ASCE 41-06 which NASA agreed upon, and this structural analysis, there are a number of deficient members. The deficient members are mostly single angles with rather high slenderness ratio. Very high slenderness ratio members become very inefficient in supporting compressive forces. This is why mostly the single angles seem to be overstressed. Based on the review of the documents the original designer has used a lot of these as tension members. According to the current codes use of tension only members are limited to secondary elements. The primary members cannot be tension only braces per FEMA 274. (NEHRP commentary on the guidelines for the Seismic rehabilitation of buildings) Section C10.5.4.2 B. Retrofits are needed to meet the current requirements per ASCE 41-6 for all members with DCR greater than one.

It is important to note that the yielding in compression of these braces will cause a redistribution of forces that cannot be captured in the elastic analysis. Since the number of deficient members and their location in the building is such that the redistribution will increase the forces in the adjacent members but may not be detrimental in overall safety of the structure.

All of the analysis considers ground improvement to allow using Site Class D for our analysis. The risk of the liquefaction for this option is mitigated by the remediation measures proposed in Section 5.0, Geotechnical Report. If the remediation is not performed, then the building needs to be re-analyzed with a time-history analysis and the retrofit design modified to consider the liquefied soils.

For the graphic depiction of the failing members, refer to Appendix G.

The retrofits are shown in section 7.B.6. The following types of retrofits are recommended. Both bolted and welded details are developed for each type that could be selected. The bolted connection is the preferred option for Historic building consideration. If the welded type connection is used, it may require added consideration due to the painted surfaces.

- In Type I retrofit (required mostly in bracing members), single angle members are proposed to be retrofitted by providing another angle of the same size angle and a gusset plate between the two angles as shown in Figure 7-1.
- Type II (Not Used)
- In Type III retrofits (required mostly in A frame members), two single angles in + configuration with a gusset plate between them are proposed to be supplemented with two more smaller single angles as shown in Figure 7-2.
- Type IV retrofit involves a double channel built-up section with an “I” beam in the middle. This section is mostly found in arch members. The section is proposed to be retrofitted by providing channel sections on each side of the “I” beam web and bolting them together as shown in Figure 7-2.

The historic material properties shall be considered in the retrofit. The retrofit should not include welding directly to the arch members, which may be made of silicon steel, see Section 3.A.8.

7.B.3 Option C - Re-Skinning and Structural Upgrades with Historic Considerations

This option provides all upgrades mentioned in Option B. Option C calls for rehabilitation with historic considerations required by California Historical Building Code (CHBC) incorporated. The preservation architect reviewed the proposed retrofits from Option B, and the retrofits do not affect the historic sightlines and meet the historic consideration requirements. For the compliance with CHBC the bolted connections are preferred.

7.B.4 Option D – Re-skinning, Structural Upgrades with Historic Considerations, Mechanical, Electrical, Plumbing, Fire Protection, and Life Safety Upgrades for Re-Use as a Hangar or an Assembly Occupancy

Option D calls for upgrades required for the highest occupancy permitted by California Building Code (2010) when the hangar is used as an assembly occupancy. For this scenario, Executive Order (EO) 12941 is applicable and the upgrades need to comply with it in addition to CBC criteria. ASCE 41-6, as referenced by CBC, for the upgrade of existing buildings uses the same acceptability criteria for both Option B and D. The basic safety objective is also the same for both Options B and D. The number and type of retrofit remains the same as the proposed retrofits of Figure 7.1 and Figure 7.2. However, for wind analysis, the building is classified as category III and the wind loads are larger due to an increased importance factor. Since most of the structure elements are controlled by seismic, the increase in wind did not have a significant effect in the retrofit system. The risk of the liquefaction for this option is the same as the remediation measures proposed in Section 5.0, Geotechnical Report. If the remediation is not

performed, then the building needs to be re-analyzed and the retrofit design modified to consider the effect of liquefaction.

7.B.5 Conclusions

Based on our evaluation and site observation of the Hangar structure, it appears that Hangar One was not only very well designed but remains in sound condition after 80 years. The deficiencies are minimal considering the size and the complexity of the building and the period when the building was designed and built. Most of the deficiencies observed are in the single angles in the braces and few Arch chords. The deficiencies noted here are to be expected considering that the design of the Hangar was done at a time when there was very limited knowledge of the seismic forces on the building. The seismic loads originally considered for the building as 1/6 of the dead weight of the building are lower than the seismic loads used for this analysis while the current codes and standards considers a number of factors in developing the seismic forces. Furthermore there have been significant changes in seismic resisting system requirements based on the knowledge gained from the recent earthquakes. Additionally, the wind loads considered were lower than the values calculated under current codes, especially for Category III.

There is no retrofit required for Option A, accepting the liquefaction risk. Option B, however, requires retrofit as shown in the following details for the steel structure and for the assumed mitigated soil condition recommended by Section 5.0, Geotechnical Report. The retrofit options remain the same for Option C. The retrofit provided above also meets the requirement of higher occupancy of Option D with some added retrofit as required for higher wind loads of Category III

7.B.6. Retrofit Details

Appendix G provides a summary of the structural members which require retrofitting. The appendix has tables which show which member receives each individual retrofit detail. The appendix also shows where on the hangar each member is located.

See the details on the following sheets.

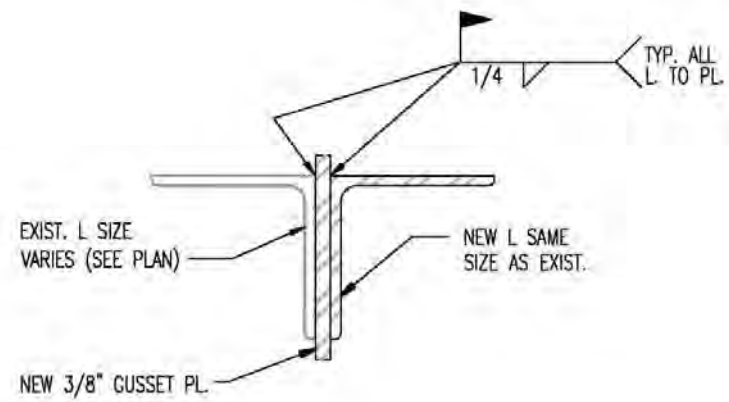

TYPE Ia

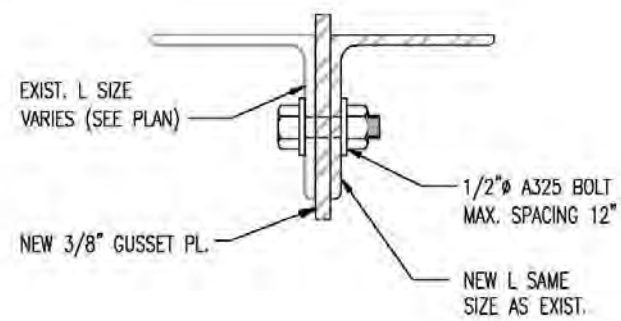

TYPE Ib

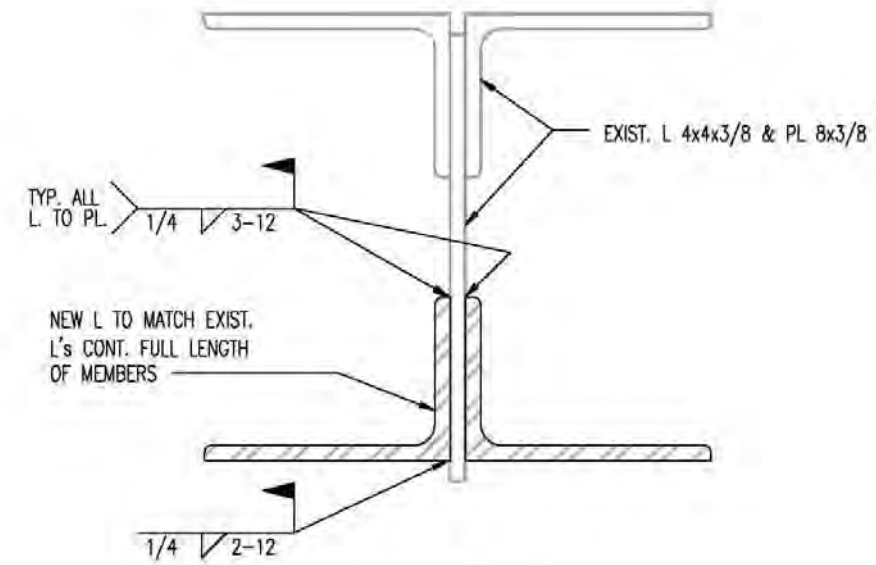

**TYPE IIa
(NOT USED)**

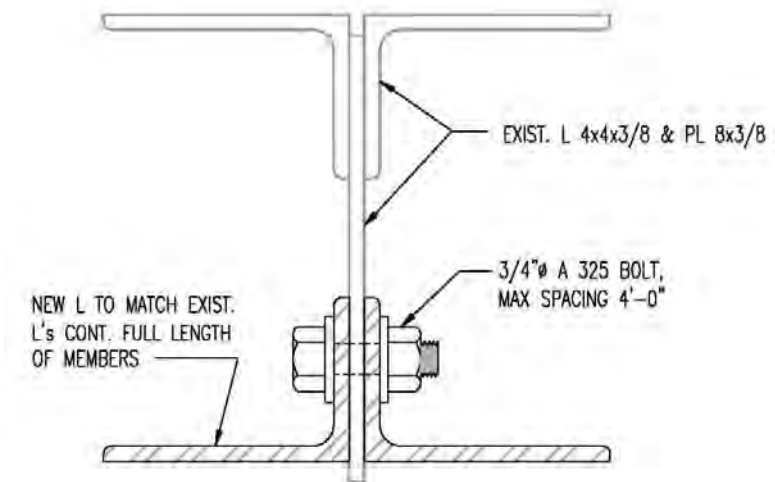

**TYPE IIb
(NOT USED)**



PROJECT: **HANGAR 1
CARP**
CLIENT: **NASA**

RETROFIT DETAILS

DRAWN: RLS
SCALE: N.T.S
JOB NO: 0000-001
REVISION:

CHECK: DK
DATE: 9-16-2011
SHEET NO:
SK-1

Figure 7-1 Retrofit Details

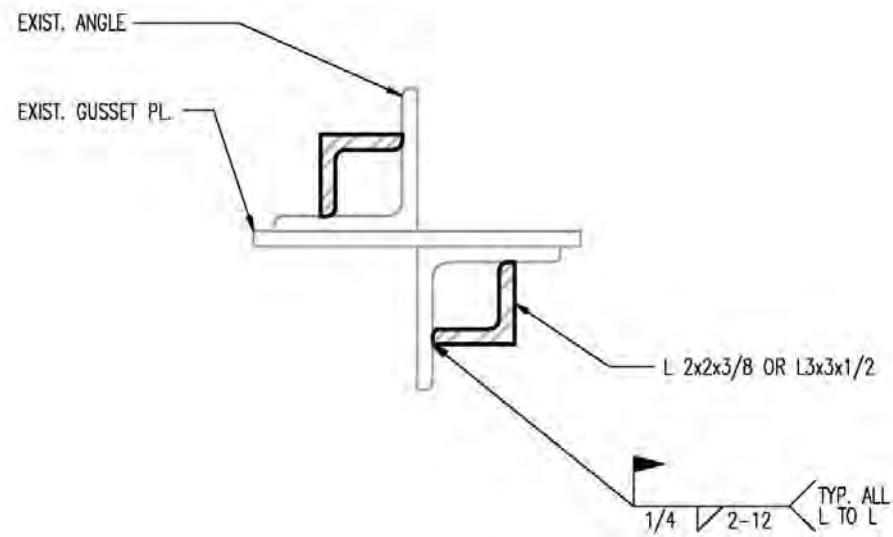

TYPE IVa

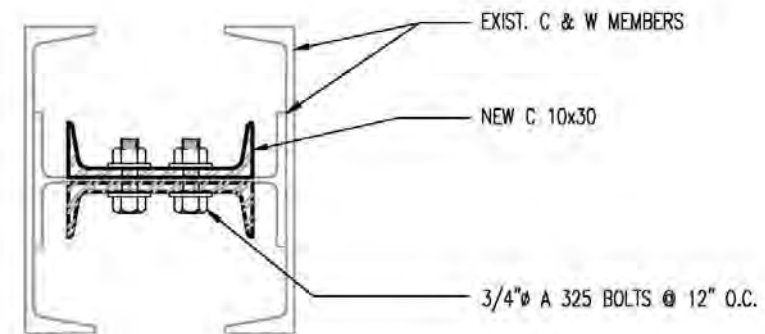

TYPE V

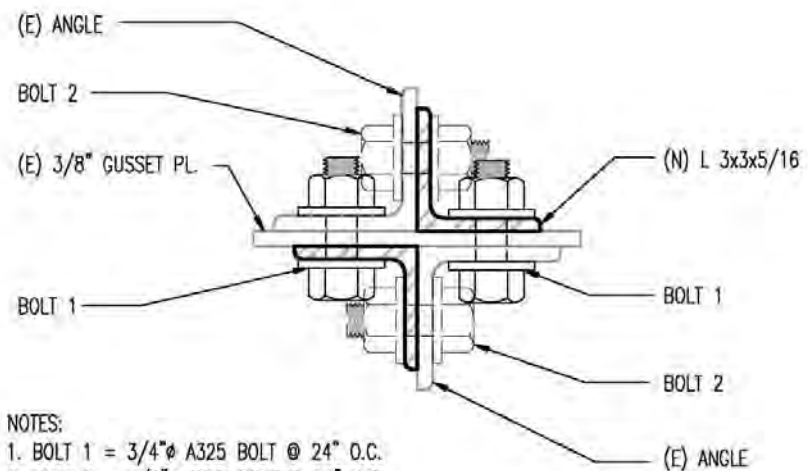

- NOTES:
 1. BOLT 1 = 3/4" A325 BOLT @ 24" O.C.
 2. BOLT 2 = 3/4" A325 BOLT @ 12" O.C.
 OFFSET ALONG MEMBER FROM BOLT 1

TYPE IVb

NOTE:
 BOLTED CONNECTIONS ARE
 THE PREFERRED ALTERNATIVE
 FOR CONNECTIONS.



PROJECT: **HANGAR 1
 CARP**
 CLIENT: **NASA**

RETROFIT DETAILS

DRAWN: RLS
 SCALE: N.T.S.
 JOB NO: 0000-001
 REVISION:

CHECK: DK
 DATE: 9/16/2011
 SHEET NO:
SK-2

Figure 7-2 Retrofit Details

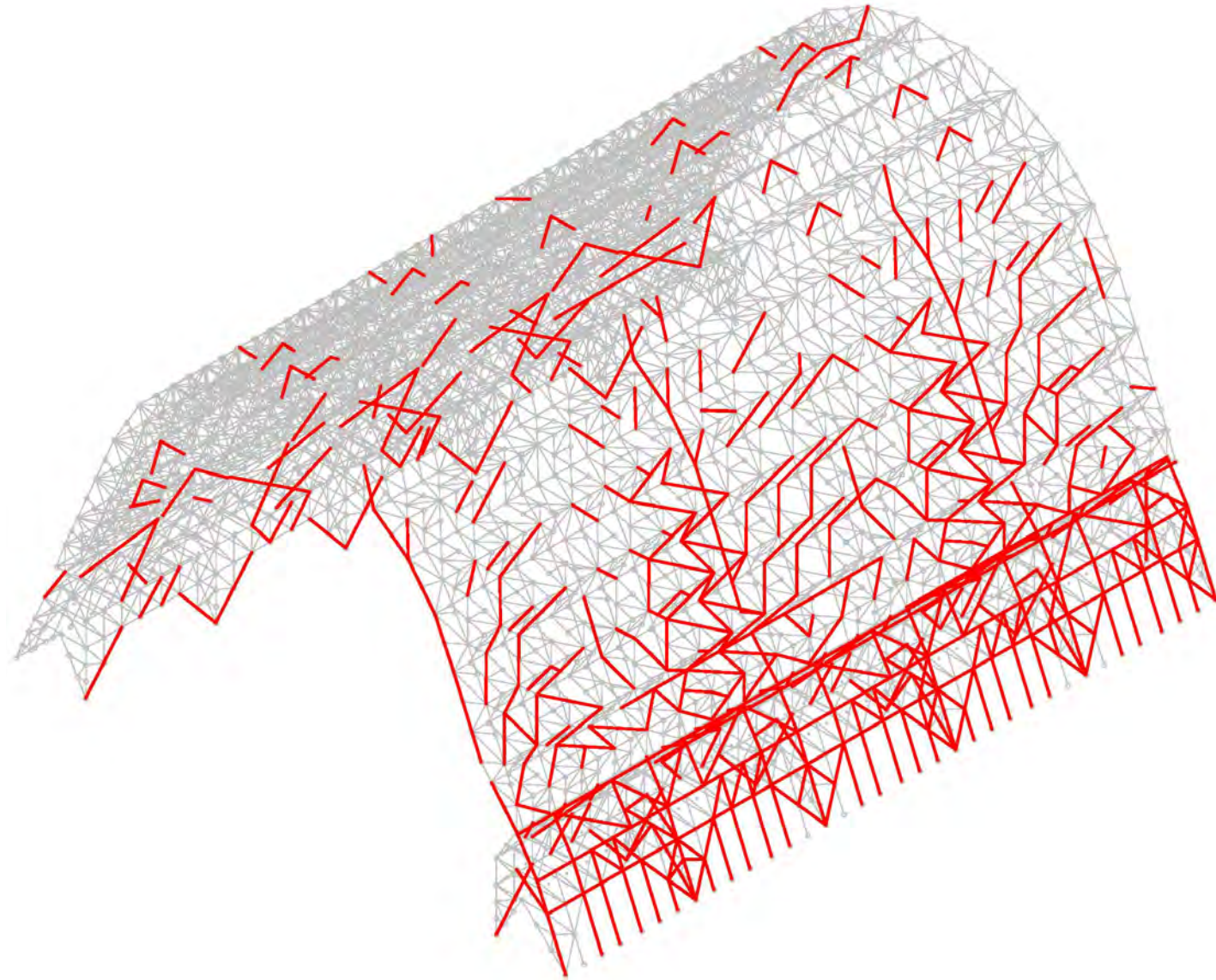

Overstressed members considering an assumed differential settlement. Note: The differential settlement is for comparison purposes only.

Figure 7-3

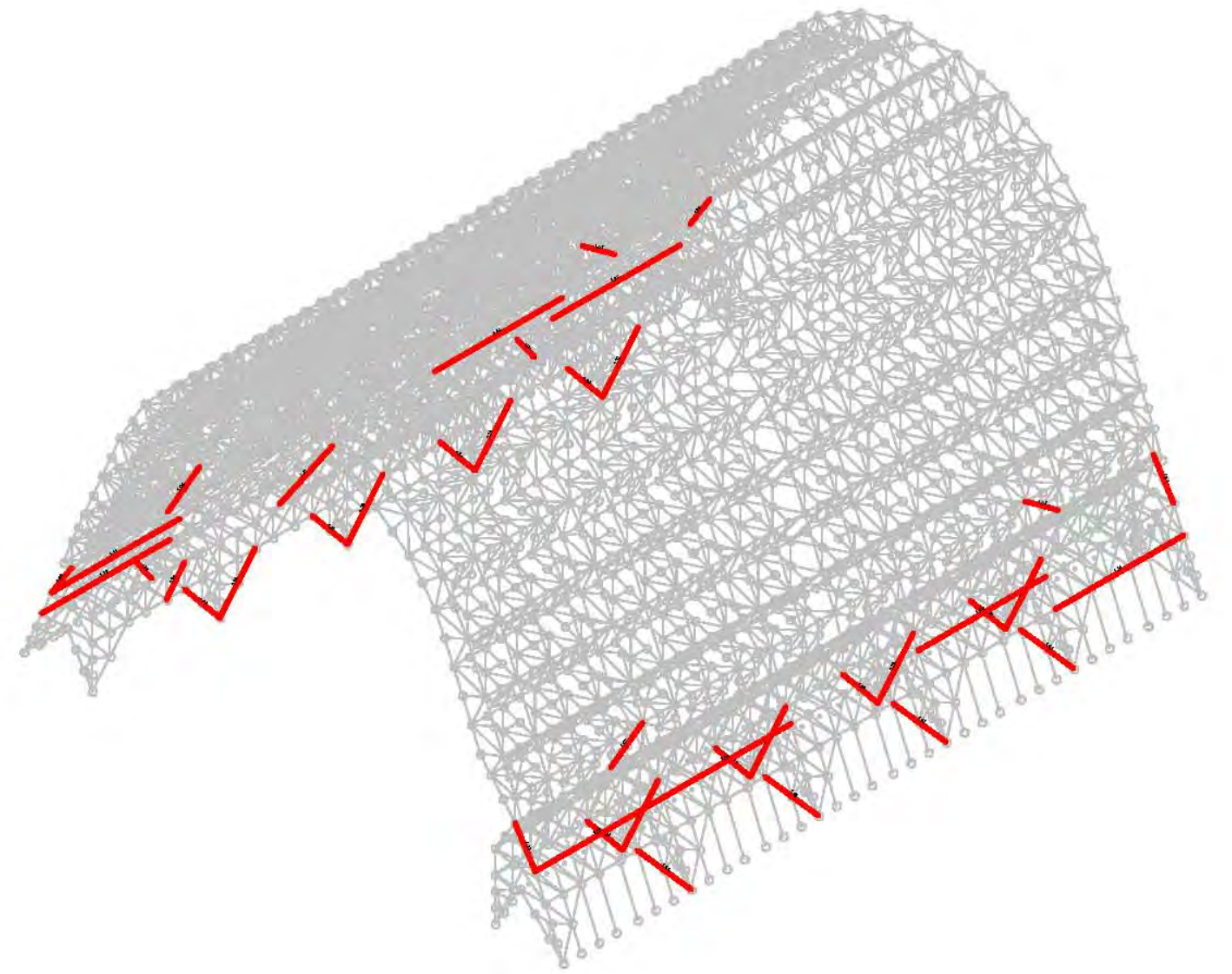

Overstressed members considering only lateral seismic forces without differential settlement.

7.C Miscellaneous Structural Rehabilitation Requirements

7.C.1 Floor Slab

The current 8 inch thick hangar floor slab, which is in the center portion of the hangar, is suitable for limited semi-truck traffic, light forklift traffic (4000 to 6000 lb capacity forklift), or a 10,000 pound aircraft axle load (based on a 100 square inch tire contact area). The current 8 inch thick slab is also capable of supporting a 700psf stationary live load, which is sufficient to support large groups of standing people. (Floor capacities were checked with the Portland Concrete Association design charts using 3000psi concrete and 50 pounds per cubic inch subgrade modulus)

The current 6 inch thick hangar floor slab, which is in the portion of the hangar floor located under the mezzanines, is suitable for limited semi truck traffic or light forklift traffic (3000lb capacity forklift). The current 6 inch thick slab is also capable of supporting a 600psf stationary live load, which is sufficient to support large groups of standing people.

Large aircraft, heavy truck traffic, storage racks, or other similar uses would need a thicker hangar slab and a prepared base course. An 18 inch thick hangar slab with a 6 inch stabilized base course would provide sufficient capacity to support large, heavy aircraft as well as significant storage and truck traffic loads. Only the portion of the slab interior to the "A" frames would need to be 18 inches thick, the outer portions of the hangar slab could remain 6 inches thick, but would not be able to support heavy wheeled traffic. The clear opening of the hangar door is approximately 200 feet wide, which is large enough to fit a 747 with a maximum weight of more than 800,000 pounds. The final hangar slab design should take into account the actual applied loadings for the chosen re-use option and the below slab soil conditions. The hangar slab loading may ultimately be either greater than or less than those assumed in this report.

There are also portions of the slab which have raised curbs that used to support interior buildings. Depending on the hangar re-use option, these curbs will likely need to be demolished.

7.C.2 Repairs of Modified Wall Openings

The one tall new opening in the east side of the hangar will need to be repaired. At this location, a wind girt was completely severed to accommodate the new opening. That wind girt will need to be replaced with a modern steel member similar to the original member. The location of the girt is shown in Figure 3-27. The figure shows the steel member at the top of concrete wall which was cut and will need to be replaced. The girt is directly above the opening shown in the figure.

7.C.3 Remediation of Contaminated Hangar Slab

The northern portion of the hangar slab which appears to be contaminated with lead dust may need to be replaced with new concrete and the contaminated material disposed of at an approved location. The Navy's removal action will remove the surface lead dust, it is unknown if the contamination extends down into the slab itself. The location and quantity of the contaminated area has not been finally determined and it should be a scope item for a future phase.

7.C.4 Steel Grating

Multiple pieces of the exterior cast iron grating around the hangar perimeter have been damaged over the years. Multiple other pieces of grating appear to have been replaced with modern grating which differs in appearance from the original grating. All of the damaged and altered grating will need to be replaced with

new cast iron grating which meets the dimensional requirements, profile, shapes, and loading capacity of the original grating. See as-built drawing M4-0001-S60 for the original radiused grating profile. Aluminum grating is not recommended because it would not match the appearance of the existing grating, and the grating bars would need to be significantly thicker to match the load capacity of the existing grating. Rusting is not a concern because cast iron is intended to have a small amount of surface rust (as can be seen in the existing nearly 80 year old grating), but does not have problems with deeper rust that would affect the structural integrity of the grating. For estimation purposes it is assumed that 15% of the grating will need to be replaced.

7.C.6 Exterior Repair Pits

There are four exterior in-ground vaults (repair pits) near the hangar door rail on which the vault lid has been corroded and needs to be replaced. The steel vault lids need to be replaced with new beams and galvanized steel, diamond checkered plate.

7.C.7 Railroad Tracks

The railroad tracks at the hangar doors have flangeway filler strips which contain asbestos and will be removed as part of the Navy's removal action. The filler strips will need to be replaced with either rubber flangeway fillers or pourable filler grout.

7.D Geotechnical Remediation

See section 5.0 for the geotechnical recommendations. Section 5.0 identifies the geotechnical hazards at the hangar, and identifies possible remediation measures. The liquefaction potential may need to be remediated with ground improvements to provide suitable bearing for the occupancy classification. These ground improvements may need to be provided at all pile cap locations. An extensive geotechnical investigation was not part of this scope and will be required to determine full required remediation scope. Completion of this investigation prior to a ground improvements program will confirm or deny the remediation requirements at each location. Any soil remediation design and future geotechnical investigations need to take into account the contaminated groundwater at the site and must be approved by NASA to ensure that the contamination is not spread or migrated into areas that are currently not contaminated. The soil remediation and future geotechnical investigations must also not interfere with the Navy's remedial measures to clean up the ground water contamination and must take into account the constraints in the USEPA MEW Study Area Record of Decision Amendment for the Vapor Intrusion Pathway. The cost estimate includes a geotechnical remediation option.

8.0 Mechanical and Plumbing Systems

8.A General Mechanical and Plumbing Discussion, Options Analysis

The following are the basic, code minimum requirements associated with the Options Descriptions noted in section 6.A Rehabilitation and Re-Use Options.

Option A, Option B and Option C:

- Heating and air conditioning of the hangar would not be allowed by code for this or for any options, as the building is not insulated
- Mechanical ventilation of the hangar would not be provided and is not required by code if at least one of the hangar doors remain operational and can be opened to ventilate the hangar

- Heating and air conditioning of the toilet rooms would likely consist of forced air, electric resistance or gas furnaces with no air conditioning. There is a gas line near the building. If air conditioning is required, the system would be air-to-air heat pumps of approximately four tons
- Toilet rooms would have code compliant plumbing, with localized instantaneous water heaters at the lavatories. There are existing cold water and sanitary sewer lines near the building to which connections would be made. Condition of the existing lines is not known and would need to be confirmed

Option D:

- Heating and air conditioning of the hangar would not be allowed by code, as the building is not insulated
- Ventilation of the hangar could be provided by opening the hangar doors. However, if the intent were to leave the doors closed or the doors were not operable, a number of large air handling units could be located around the perimeter of the hangar to provide un-tempered but filtered outside air. For uses similar to enclosed sports stadiums, four air changes per hour for a volume from the floor to a height of fifty feet would require one million cubic feet per minute (cfm) of outside air, which could be achieved with twenty air handlers of fifty thousand cfm each, located near the floor, with a similar amount of exhaust, taken higher, to relieve the air from the hangar. Unlike most enclosed stadiums, indoor temperature would be similar to outdoor temperature. For other uses, smaller and fewer air handlers might be required for ventilation
- Any spaces that need heating and air conditioning would require fully enclosed and insulated buildings, located within the hangar, with HVAC systems in compliance with the California building codes and the California Energy Code. These buildings would not need to be impervious to rain, but would otherwise be the same as conventional buildings
- Plumbing and heating of toilet rooms would be similar to Option A, except on a larger scale to meet the required fixture counts. Existing cold water and sanitary sewer lines appear to be large enough to handle the building loads. Condition of the existing lines was not confirmed as part of the Condition Assessment

8.B Moisture and Interior Climate Issues (Options A through D)

Water drips from the roof structure on an intermittent basis. Historic record mentions that clouds formed inside the building under certain circumstances many decades ago. More recently, water has collected on the floor from an undetermined source. Re-skinning the hangar should include measures to eliminate/minimize future dripping. At the same time, resources should not be spent on efforts that will not address future problems.

The most likely causes and the most likely solutions of the dripping include the following elements.

8.B.1 Clouds

Some dripping may be the result of cloud formation and condensation from the clouds; however, based on available records and recollections, this appears to be unlikely. Clouds or mist were observed to be drawn in from outside when the hangar doors were open, but not generated within the space itself. Mitigation is not proposed, as it is unlikely that this is the problem.

8.B.2 Warm Moist Air

The most likely cause of most dripping would be the result of relatively warm, moist air infiltrating through the building and condensing on roof structural members that are below the dew point.

- Most likely cause: This condition would occur at times when it tends to be foggy or high humidity outside, when the inside of the hangar becomes cool, such as on a foggy, fall day. The metal structure would be below the dew point of the fog or moist air, causing condensation on the structure. This is consistent with reported recollections that the dripping occurred in the fall and winter. Similar facilities, such as the Vehicle Assembly Building, at Cape Canaveral, use air conditioning to address this problem, but the climate in Florida is hot as well as humid. A better solution for this facility is to keep the moist air out, and to add a small amount of heat high within the structure. At the Hangar One location, air conditioning would be counterproductive, as would ventilation, which would increase infiltration.

Approaches to minimizing infiltration:

1. Keep the hangar doors closed under those conditions when condensation is likely to occur. If the hangar doors are opened on foggy fall and winter days, there is no practical means of preventing condensation on the structure.
2. Reduce infiltration by sealing gaps between the closed hangar doors and the building. This would require a gasket system added to the hangar doors.
3. Reduce infiltration by adding counterbalance backdraft dampers with manual locks to the new ridge vent system. The dampers would allow air to be relieved from the building during warm weather, but would prevent cold, moist air from blowing back through the vents in the fall and winter. If the counterbalance were not sufficient to prevent infiltration in the winter, the manual locks could be closed seasonally to ensure the dampers stayed closed.
4. Reduce infiltration by making sure that the new metal skin and other envelope elements are sealed as well as practical.

Approaches to ensure roof structure is above the dew point of the air:

1. Historical records indicate that the condensation problem got better after the roof was painted black. It is likely that the dark roof absorbed more solar energy, which heated up the underlying wood structure. The additional heat may have kept the roof structure just warm enough to prevent condensation much of the time. The wood sub-roofing is to be replaced with insulation, which will reduce, but not eliminate this effect. The new insulation is a better insulator than the wood, so will reduce solar energy into the building. It also has less thermal mass, so will hold less heat over time. Therefore, a dark roof will help, but not as much as before.
2. A small amount of supplemental heat could be added to the roof structure to help keep it above dew point temperature. A good way to do this would be with gas fired black body radiant heaters. These would appear as long tubes with periodic burners and reflectors, aimed up to direct the radiant heat to the roof and structure. The bottom side of the reflectors could be anodized a color that would match the roof. Two rows would be used, one on either side of the centerline of the building. If infiltration is minimized, as recommended above, the heat required to keep the structure above dew point temperature would be minimal. Controls could include sensors that would measure truss

temperature, and dew point temperature of the air, to provide just enough heat to keep the trusses above dew point temperature.

8.B.3 Rain Penetration

Some dripping may be the result of rain penetrating through the roof system.

1. Most likely causes: Leaks through the roof membrane, or through the vents, windows or other devices.
2. Recommended solution:
 - Ensure that the new envelope and new vents do not leak.

9.0 Fire Protection

9.A Fire Protection, Options Analysis

The following are the basic, code minimum requirements associated with the Options Descriptions noted in section 6.A Rehabilitation and Re-Use Options.

9.A.1: Option A, Option B and Option C:

- Provide a smoke detection system in the hangar
- Provide manual fire alarm pull stations at each exit and at 200 foot minimum travel distances between pull stations
- Provide audible/visual notification devices throughout the hangar
- Install a new addressable fire alarm control panel (FACP) with Monaco transceiver and antennae
- Provide a wet pipe fire suppression system in the new toilet rooms and utility rooms with capabilities for expansion into potential future tenant build-out spaces
- Provide fire extinguishers throughout the facility per NFPA 10 requirements. Travel distance shall not exceed 75 feet. Provide wheeled extinguishers in areas classified for hangar use
- Provide an HEF system to cover hangar floor area and meet the following requirements:
 - HEF generators to cover the floor with one meter of HEF in four minutes
 - HEF equipment room with required equipment and components
 - HEF manual pull stations and HEF blue horn/strobes in hangar area

9.A.2: Option D:

- Provide a smoke detection system in the hangar
- Provide manual fire alarm pull stations at each exit and at 200 foot minimum travel distances between pull stations
- Provide audible/visual notification devices throughout the hangar
- Install a new addressable fire alarm control panel (FACP) with Monaco transceiver and antennae
- Provide a wet pipe fire suppression system in the new toilet rooms and utility rooms with capabilities for expansion into potential future tenant build-out spaces
- Provide fire extinguishers throughout the facility per NFPA 10 requirements. Travel distance shall not exceed 75 feet

9.B General Fire Protection Discussion

Due to the height of the hangar, the installation of a wet pipe sprinkler system at the interior of the high bay spaces is not practical. The water droplets formed by a typical sprinkler head are so small that the water droplet will be either evaporated or turned to steam long before the water droplet has traveled the 180 feet from the peak of the hangar to the floor where a fire would likely be located. Water would not reach the fire in any quantity to effectively control a fire of any size.

Newly constructed occupied spaces such as offices, storage rooms, etc. within the existing building area that would not be open to the high bay hangar spaces above would be required to be protected throughout by a fully automatic wet pipe sprinkler system designed in accordance with UFC 3-600-01 and NFPA 13 requirements. The system is required to be hydraulically designed. The sprinkler system inspector's test drain will need to discharge at the exterior wall to grade. All materials in concealed spaces and attic spaces are required to be noncombustible and all cabling is required to be plenum rated.

Classification of newly constructed occupied spaces will be predominantly Light Hazard with boiler room, mechanical room, storage spaces, utility rooms, etc. classified as Ordinary Hazard 1 and 2 as required. The sprinkler design area will be 3,000 square feet. Hose allowance will be 250 gpm for Light Hazard and 500 gpm for Ordinary Hazard. Water velocity in the sprinkler piping cannot exceed 20 feet per second and a 10% pressure safety factor will be required.

Sprinkler heads throughout sprinklered rooms are required to be quick response type. Sprinklers in rooms with finished ceilings will need to be the recessed type with chrome finished sprinkler head and escutcheon. Sprinkler heads in ceilings with grid-supported tile will need to be located a minimum of 6 inches from the ceiling grid.

9.B.1 Fire Extinguishers

Provide fire extinguishers throughout the facility per NFPA 10 requirements. Fire extinguishers will be located near exterior egress from the facility, with additional locations as required by the 75 foot travel distance requirements in NFPA 10. Extinguishers will be 10 pound dry chemical type 8A:80B:C minimum.

9.B.2 Fire Alarm and Mass Notification Systems

For options that provide future occupancy within the hangar a combined Fire Alarm and Mass Notification System will be required. This includes Fire Alarm/Mass Notification Control Panel, Fire Alarm Remote Local Operating Console (LOC), Autonomous Unit, Annunciator, alarm initiating devices, alarm notification appliances, signaling devices, wiring, and testing.

The fire alarm system shall be UL listed, addressable, zoned, non-coded with full control, supervisory, alarm signal, display, and 72-hour battery back-up per NFPA 72. The main fire alarm panel should be located at the fire department first response point. A remote annunciator panel shall be located at the main entrance to the building. Remote reporting of the fire alarm system will be provided to the Base Fire Department Monaco D-21 system. Provide a Monaco transceiver at the new fire alarm panel and include Omni-directional antennae, mounting hardware, coaxial cable, and lightning arrestor.

Install a solid-state, electronic fire alarm system consisting of double action manual pull stations at any mechanical, communication, and electrical rooms, and at all building exits at grade; combination speaker and strobes throughout building, clear for alarm and amber for MNS; and duct smoke detectors in the

required air-handling units in both supply and return ducts. The fire alarm system audible notification shall be muted upon activation of a mass notification system announcement.

Install a MNS local operating console (LOCs) located within the area constructed for offices, storage, etc. that includes the emergency air shut-down button. Additional LOCs will be required to meet the 200 foot travel distance as required by UFC 4-021-01 requirements.

All fire alarm wiring shall be in a minimum of 3/4 inch factory painted red conduit. All signal line circuit and initiating device circuit conductors shall be a minimum of #18 AWG solid copper. All audible notification appliance circuit (NAC) conductors shall be a minimum of #16 AWG solid copper. All visual NAC conductors shall be a minimum of #14 AWG solid copper. Conductor gauge will be increased according to voltage drop calculations that shall be submitted by the Contractor for approval prior to installation.

Install a weatherproof horn or bell with a strobe light located on the exterior of the building at the fire department connection per NFPA 13.

10.0 Electrical, Public Address and Communication Systems

Systems shall be designed in accordance with the NASA versions of the current applicable Uniform Facilities Guide Specification (UFGS), National Fire Protection Association (NFPA) codes and industry standards. The USGS include 26 05 00.00 40 Common Work Results For Electrical, 26 05 71.00 40 Low-Voltage Overcurrent Protective Devices, 26 12 19.00 40 Pad-Mounted Liquid- Filled, Medium-Voltage Transformers, 26 23 00.00 40 Switchboards and Switchgear, 26 24 16.00 40 Panelboards, 26 41 00.00 40 Facility Lightning Protection, 26 51 00.00 40 Interior Lighting, 27 05 28.36 40 Cable Trays For Communications Systems, and 27 13 23.00 40 Communications Optical Backbone Cabling. Comply with, NFPA 101 Life Safety Code, 70 National Electrical Code, and 780 Lightning Protection Code. Follow EIA/TIA 568B.1 and EIA/TIA 569 standards for telecommunications.

In consideration of the great size of the building systems must necessarily be organized with an absolute minimum of six permanent distribution points in an arrangement roughly similar to the existing electrical vault locations. These are required to provide power distribution without excessive conductor upsizing for voltage drop and to stay within the maximum station cable lengths specified for structured copper telecommunications distribution. In the more advanced development scenarios additional subsystems (power and telecom) shall be provided in a manner most cost effective to the actual design arrangements; however, a permanent "core" arrangement shall be established which will support immediate needs for development as well as providing for future modifications, replacements and additions with minimum modifications therein. The systems, subsystems and spaces shall be developed as part a fully functional facility.

A minimum of six electrical rooms with minimum one-hour fire ratings shall be created to house power distribution for HVAC systems, miscellaneous utilization equipment, general and special purpose receptacles, and interior and exterior lighting. The electrical rooms shall also house electrical energy usage metering, dry-type transformers and lighting controls. A minimum of six companion telecommunication rooms shall also be created to house public address and telecommunications equipment and provide external connectivity via fiberoptic and copper backbone cabling and the horizontal (station) copper cabling distribution throughout the facility for telephone and data.

10.A Power Systems

Optimize the number and location of electrical rooms to be installed throughout the facility while meeting the minimum "core" requirements stated above. Each electrical room will contain all of the necessary equipment needed to supply the connected equipment to be installed in the section of the building it serves. This may include switchboards, distribution panels, motor control centers, transformers, panelboards, rectifiers, inverters and UPS equipment. Low voltage systems shall be 480Y/277 volts and 208Y/120 volts, three-phase four-wire grounded.

Assuming the building load is equally divided among each of six electrical rooms a minimum capacity of 500kVA nominal with 133% continuous overload capacity shall be provided at each electrical room. That is a minimum two 1500kVA liquid-filled pad-mount transformers, one for each side of the building. In accordance with the National Electrical Code for services over 2000 amperes at least two services are anticipated. Additional space will be required for main distribution switchboards in the center electrical rooms on both sides of the building. Each of the minimum six electrical room shall have a local distribution capacity of at least 800 amperes continuous (655 kVA) at 480 volts three-phase.

The new pad-mount transformers will be fed from existing medium voltage distribution equipment. Transformers shall include integral fused overcurrent protection and surge arrestors on the primary side.

Power distribution wire throughout the facility shall be copper. Generally the most economical wiring methods conforming to the codes and standards may be applied for specific circuits as determined by the final design requirements of the system and specific occupancy use requirements.

Facility lighting will be fed from dedicated 480Y/277-V, 3-phase, four-wire, lighting panelboards. Install these panelboards so that each functional area will have its own panel.

General office and staff area general purpose receptacles will be fed from dedicated 208Y/120-V, 3-phase, panelboards distributed such that each functional area will be covered by a local panelboard. Where computer and similar non-linear loads comprise more than 20% of the 120-volt load separate dedicated 208Y/120 volt, three-phase, four-wire panelboards shall be installed in the area of the facility where the non-linear loads are served. All main distribution equipment and each panelboard shall be equipped with transient voltage surge suppressors.

All lighting will be supplied at 277 vac. Open hangar areas shall be illuminated with pulse-start metal halide fixtures and other interior lighting shall be fluorescent. Exterior lighting will be color corrected, high-pressure sodium. New light fixtures shall be selected to reflect the period of the building and are subject to approval of California State Historic Preservation (SHPO).

Provide seismic bracing of all electrical fixtures, conduits, and equipment with all necessary steel, hardware, devices, and factory-manufactured components provided.

10.B Communication Systems

All telecommunications cabling/wiring will comply with ANSI/EIA/TIA 568B standards for a Category 6 installation. All installers will be manufacturer certified. Building grounding and bonding of telecommunications system will meet ANSI and EIA/TIA 607 requirements.

A common communication cable tray system will be designed for distribution of Category 6 telephone/data and public address communication cables to office areas, facility areas and other rooms. Cable trays will be installed above the drop ceiling in corridors, terminating in rack-mounted patch panels in communication rooms. All cables specified for application on this project will be listed as plenum rated. Interconnection of communication racks will be designed with fiber optic cable systems for data and copper for voice. Conduits will be specified for installation to interface between the cable tray system and room outlets throughout the facility and between the cable tray system and the communications rooms.

Data and telecommunications distribution racks (2,134 mm) located in the communications rooms will be the type designed to mount from the floor. Separate Category 6, 48-port patch panels will be specified for data and telecommunications cabling, with cable routed to prevent intermingling of system types. Distribution equipment will be designed to meet the requirements of the RFP, EIA/TIA 568B.1 and EIA/TIA 569.

A public address (PA) system is pending future occupant requirements and should be interconnected and interfaced with the telephone system. Sound levels of the installed system will meet NFPA requirements. The selected system will have the functionality for all paging modes to be initiated from any facility phone with page response delivered from a handheld device. This system will include microphones, amplifier, mixer, speakers, matching transformers, volume controls, conduit, cables, and outlets.

10.C Options Analysis

In addition to the above electrical scope, the following assumptions have been made and may need to be required with regard to the specific use options discussed previously:

10.C.1 Option A, Option B and Option C:

Lighting:

- Provide pulse start metal halide lighting for the high-bay hangar areas
- Provide T-5 fluorescent fixtures for all other interior spaces, for example toilet rooms and utility rooms
- Provide lighting control system for hangar open areas by zones and levels, minimum six zones and two levels
- Provide a combination of fluorescent lights with self-charging battery packs and unit emergency lighting equipment with higher-power quartz lighting heads for emergency egress illumination. Emergency lighting in areas illuminated by metal halide shall have integral time delay off to maintain illumination during the metal halide restrike delay

Power:

- Provide new permanent electrical services and pad-mount transformers for the building; this is a minimum of two large or six small transformers as described above
- Provide electrical rooms, each with a distribution for the respective area, provide six minimum permanent electrical rooms
- Provide 20 amp convenience receptacles distributed throughout all spaces

Communications:

- Provide new permanent communication rooms (six minimum) with additional satellite communications closets as required or otherwise cost-effective
- Provide horizontal distribution to communication outlets with conduit and cable tra

10.C21 Option D:

Lighting:

- Provide as described above.
- Provide T-5HO fluorescent fixtures for larger and high ceiling spaces
- Provide T-5 fluorescent fixtures for all other interior spaces
- Provide a lighting control system for open hangar as described above.

10.D Analysis of Solar Photovoltaic Systems

NASA Ames has determined that there is no payback for solar photovoltaic systems for this project. However, if this were to change or if a future tenant would require the addition of a solar photovoltaic system we have considered two alternatives:

- Provide a thin film photovoltaic system over the roof area currently covered with built-up roofing (approximately 40,000sf of potential surface area). Based on a thin film product manufactured by Outpost Solar (+/-5.8 watts/sf) there is a potential for an ideal, peak generating power of 232kW
- Provide a thin film photovoltaic system over the roof area currently covered with built-up roofing and metal panel profile two – mansard (approximately 125,000sf of potential surface area). Based on a thin film product manufactured by Outpost Solar (+/-5.8 watts/sf) there is a potential for an ideal, peak generating power of 725kW

In both cases a thin film PV system would be applied to a metal roof panel system. In order to meet readily available and standard thin film PV widths of +/-15" a standing seam type roof panel would be installed. This will have visual impacts to the hangar that may be of concern to the oversight entities for the Shenandoah Plaza National Historic District.

Flexible thin film solar panels with a weight less than 1psf will not have any impact on the structural capacity because the structural analysis includes a miscellaneous load greater than 1psf. Traditional solar panels with weights up to 5 psf would require additional structural analysis and additional structural retrofits.

11.0 Specialized Construction Issues – Means/Methods Discussion

11.A Site Access and Conditions – Post-Removal Action

Upon completion of the Navy's current demolition contract, the site will be secured to prevent access until the new siding and window replacement project occurs. The site is assumed to be as observed during the conditions assessment walk-through in July 2011, with concrete paving in place on all four sides of the facility, and a chain link fence securing the site.

Access to the Hangar One building site will be provided for the re-skinning project in accordance with standard Ames Research Center protocols. The existing temporary fencing surrounding the Hangar One site will remain following the Navy removal actions and become the property of NASA.

A project specific safety plan will be required prior to completion of any construction on Hangar One. The Contractor shall address all processes related to the special methods used to install all materials, including crane plans, scaffolding, working near and within contaminated materials, and environmental protection.

The steel structure of Hangar One will be painted and left exposed by the Navy's contractor. Any contaminants remaining on the steel will be encapsulated by the new coating. This coating system is to be protected from damage.

The contractor shall identify and put into practice, any and all means necessary to protect the existing structure from damage during construction activities.

All work shall be done in accordance with OSHA requirements, latest editions as applicable.

11.B Metal Siding and Window Installation Issues

A combination of several factors make construction on Hangar One unique. The height and geometry of Hangar One are not commonly seen in a single building. Installation of siding, windows, and structural repairs will require that the contractor utilize cranes and/or scaffolding suited to meet their proposed installation details and methods.

The siding material is attached to the structural with an exposed bolt and clip system. According to records available, this method was achieved by the use of a scaffold system set up inside the structure. In this manner, installers installed siding starting at the lowest level and moved vertically. Accessing the point of installation from the scaffolding, fasteners were inserted through the siding and the clips, and a nut was attached to the end of the bolt, securing the siding to the steel channel structure.

During the project to remove the siding and windows, the contractor working for the NAVY utilized a unique scaffolding system. Tall, vertical scaffold was utilized for the majority of required access, however at the top of the Hangar, chain hung (suspended) scaffold was utilized. This method maintained clearance under the scaffolding and reduced the amount of scaffolding requiring regular inspection.

Similar panels are regularly used in construction today, however the fastening methods are much different. Rather than utilize clips, fasteners are installed through the siding directly into the steel channels, eliminating the clips of the earlier design.

Details for proposed installation of replacement siding are covered in Section 6.B Material Replacement and General Discussion of Material Alternatives. In either case, fasteners need to be inserted from the exterior. To accommodate this, the contractor will be required to develop a means of accessing the exterior of the panels in order to install the fasteners.

Window details are to be done to match appearance of original windows. This is to be coordinated with siding installation, but may require some exterior access via cranes, climbing equipment, or other means.

Whether siding or windows are installed individually or in panels, the design-build contractor will be required to develop an installation plan which includes:

- Installation details
- Scaffolding plans and details
- Crane strategy, including slabs to support crane loads
- Method of lifting materials
- Safety plans
- Methods of protection existing structure
- Quality control methods
- Inspection methods
- Laydown area requirements for storage and assembly of panels
- Protection of metal panels if there is any external access on top of it for the installation of windows.

All attachments to the structural steel that are done for the purpose of installing siding, windows, structural improvements, or other construction are to be done with a structural clip attachment that can be fully removed without damage to the structure. Any damage to the coating system is to be repaired with a coating to match existing. Structural loading of all temporary elements is to be verified by a licensed structural engineer to confirm temporary loads are within the capacity of the building.

11.C Health and Safety Discussion

As noted above, the steel structure of Hangar One will be painted and left exposed by the Navy's contractor. Any contaminants remaining on the steel will be encapsulated by the new coating. Any work which involves damaging the coating system must be done so in accordance with an approved method statement that addresses dealing with hazardous materials, including collection of material, disposal of waste materials, worker safety, protection of people and materials, etc.

Due to the unusual height and shape of the structure, the contractor will be required to prepare method statements that describe in detail how materials will be installed. Include diagrams, descriptions of systems, and safety measures required. This may include crane strategies, scaffolding systems, and/or specialized equipment. Identify means of maintaining systems and how each system is maintained to comply with occupational health and safety requirements.

All work is to be done in accordance with local, state, and federal regulations. A Safety Plan is required from the contractor identifying all required safety procedures and compliance requirements.

All design and construction must comply with OSHA requirements. Where details have historic impacts the contractor shall supply sufficient details to NASA in order for waivers to be submitted.

The contractor is to employ qualified staff or consultants to coordinate all safety requirements.

Access to the site during construction for the Owner's representative is to be maintained in order to allow for inspections, quality control, and verification procedures. Access restrictions and requirements are to be identified in the contractors safety plan.

11.D Phasing and Sequencing

The contractor shall be solely responsible to develop a phasing and sequencing scheme for installation of new materials. There is no requirement for completing one portion of the building before another portion.

11.E Site Utility Access, Conditions and Locations

Service connection points are identified in the drawings included with the Condition Assessment as Appendix D- Utility Condition Drawings. These drawings include the most current information regarding the following utilities as provide by the NASA Ames Research Center. These utility services have not been evaluated and will require further investigation to determine their condition and whether upgrades are required beyond the hangar footprint.

paving which is removed to provide access for connections is to be replaced with concrete of the same strength, thickness, finish, and grading as the existing.



Figure 11.1

- Communications
- Electrical Distribution
- High Pressure Air
- Natural Gas
- Sanitary Sewer
- Steam
- Storm Drain
- Water System

Existing electric, potable water and sanitary waste lines are available within or adjacent to the building. Connections to each of these services are to be done at vaults or other existing structures noted. Concrete

12.0 Support Drawings

Basic drawings are provided hereafter to document and demonstrate the project aesthetic requirements associated with the previously discussed Options and document material locations, door locations and aesthetic requirements associated with the previously described period of significance.

12.A Plans

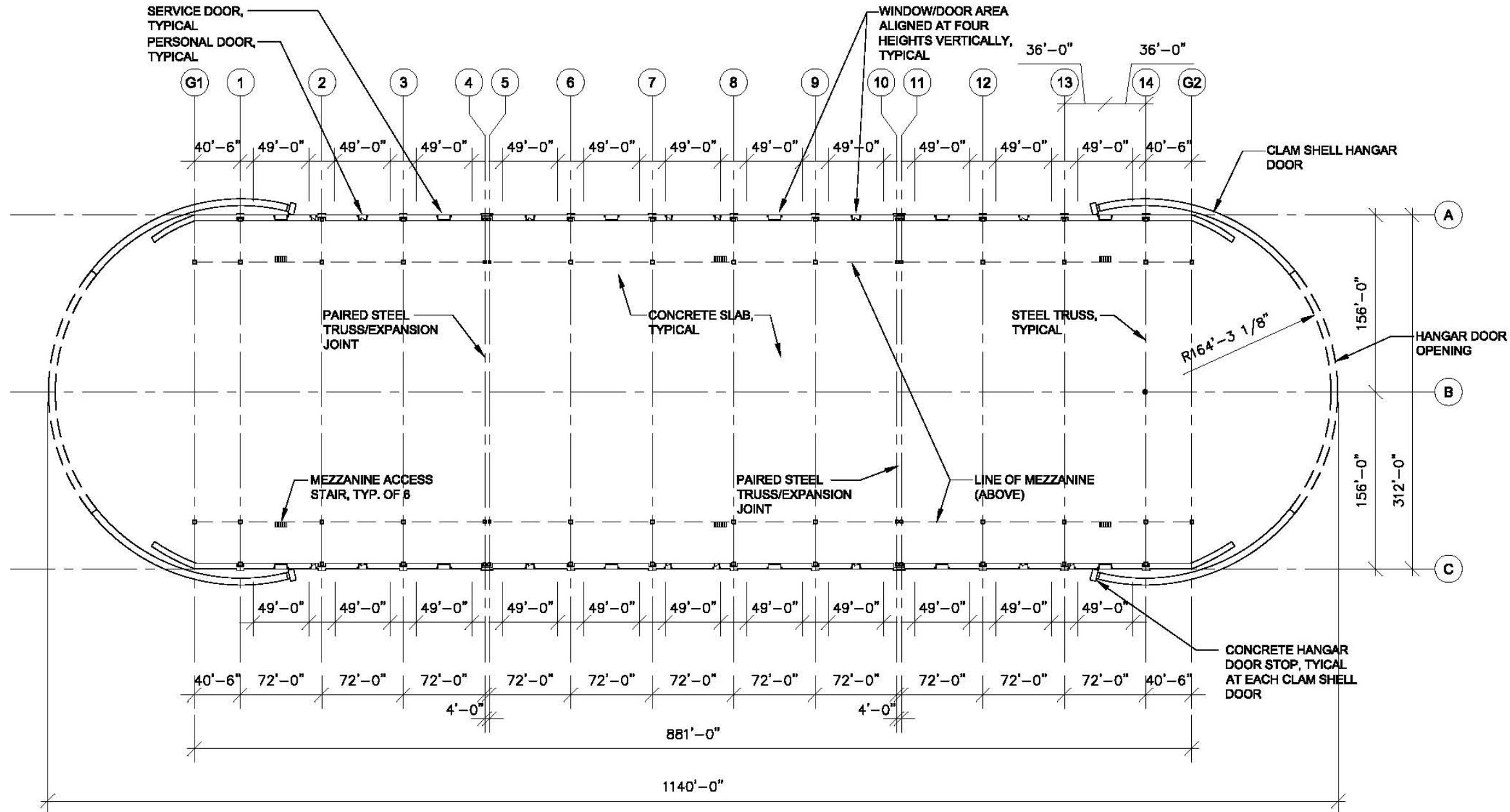

 **HANGAR ONE - FLOOR PLAN**

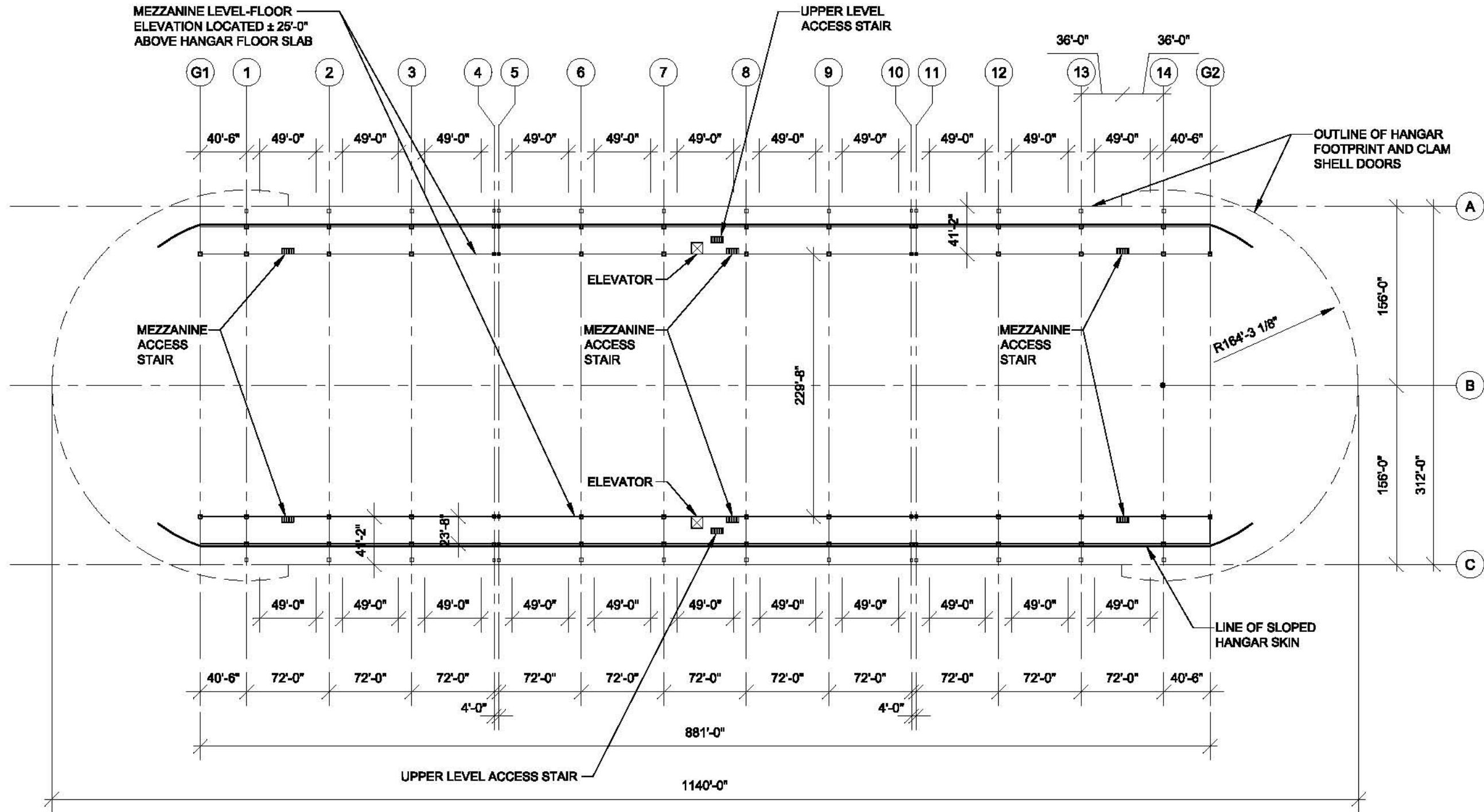

 **HANGAR ONE - MEZZANINE PLAN**

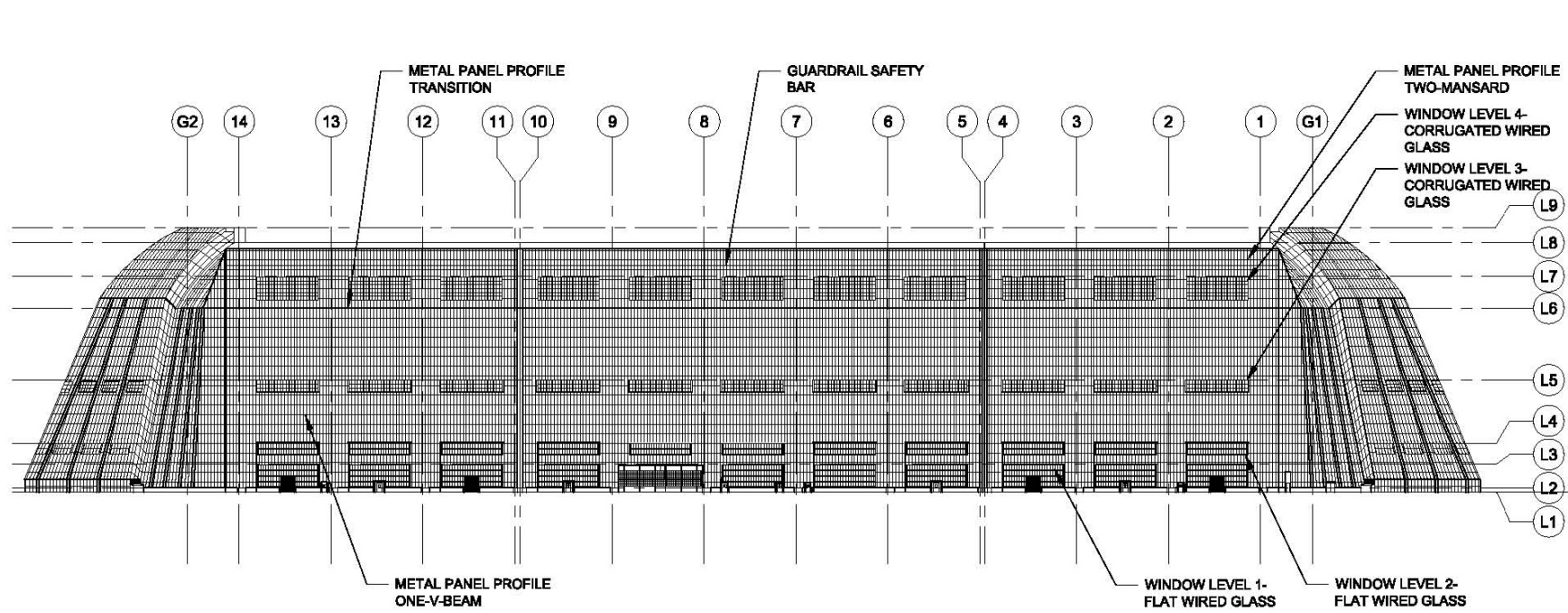

EAST ELEVATION

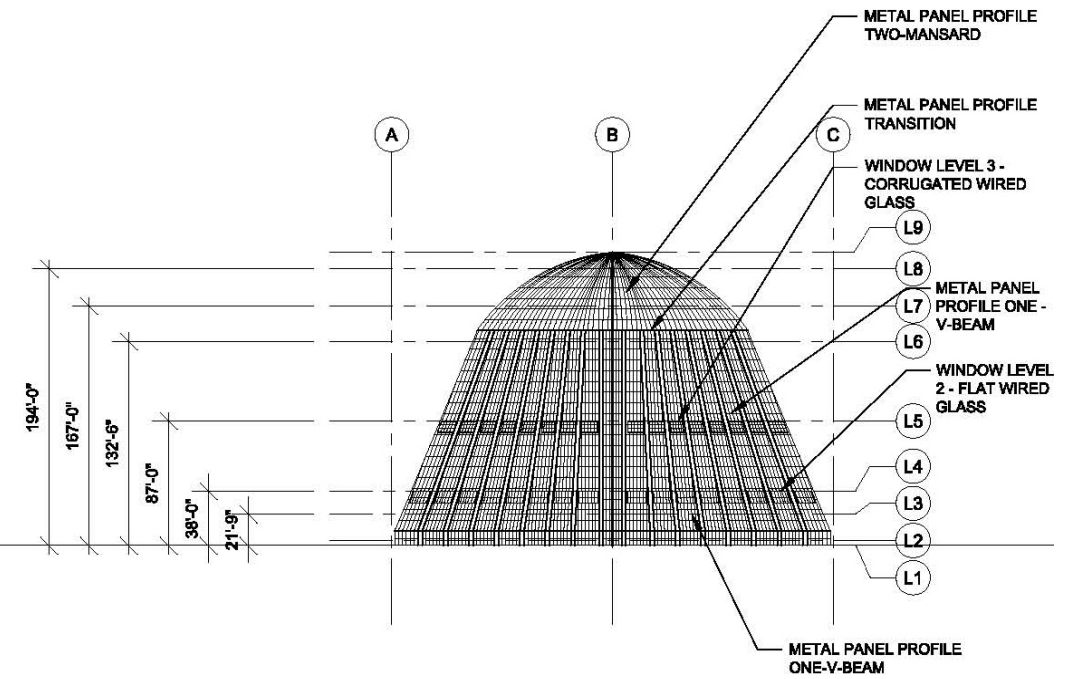

SOUTH ELEVATION

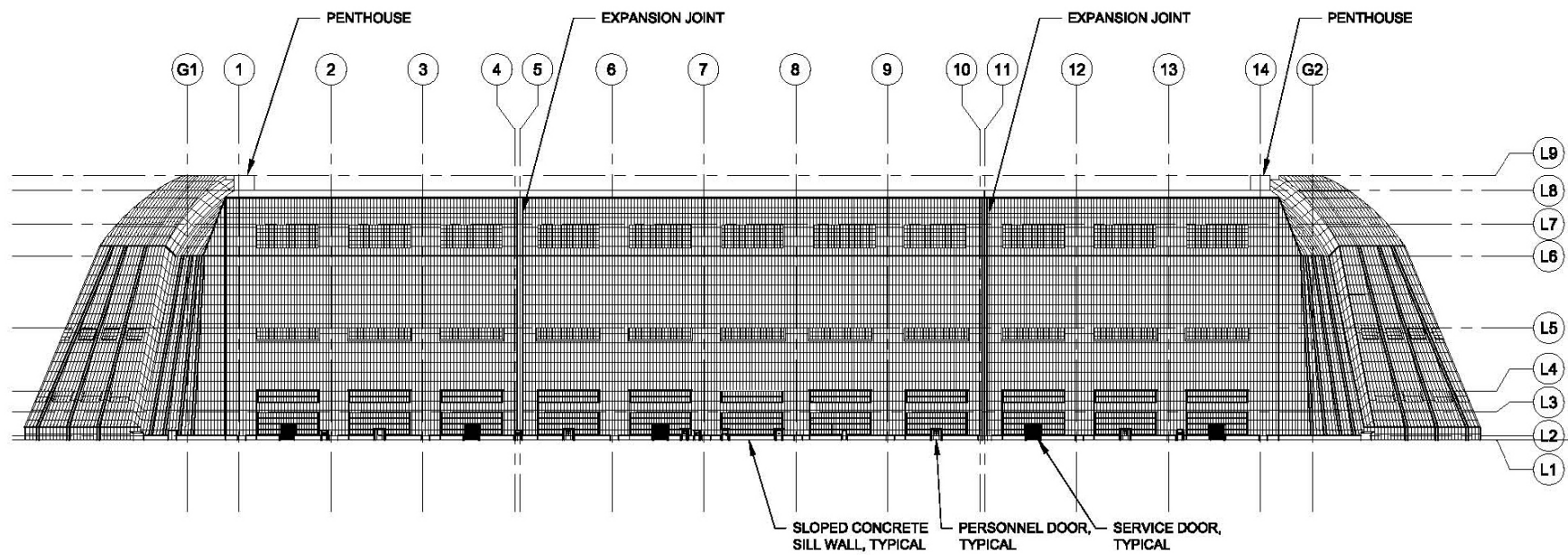

WEST ELEVATION

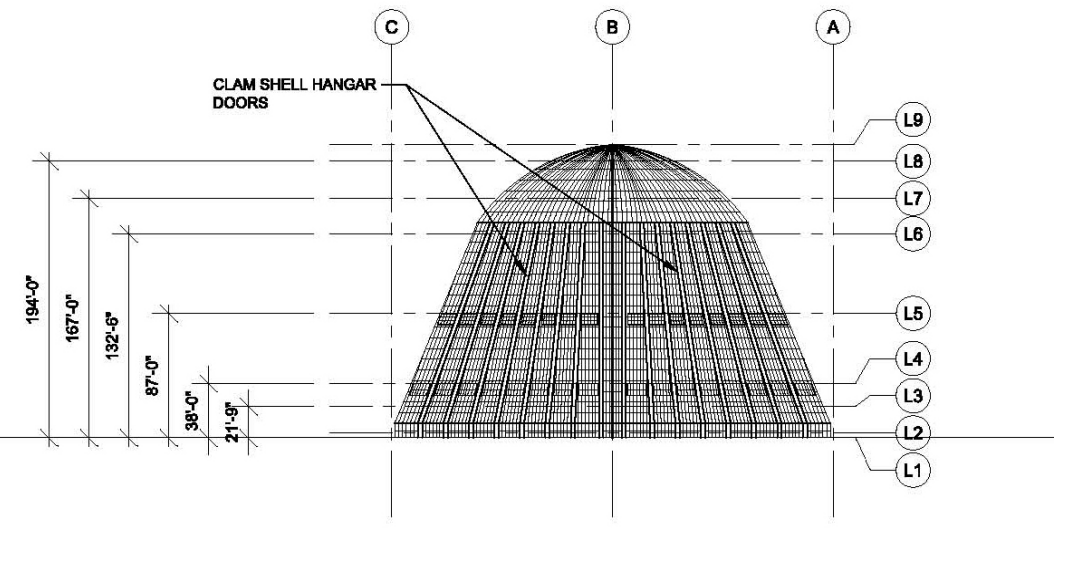

NORTH ELEVATION

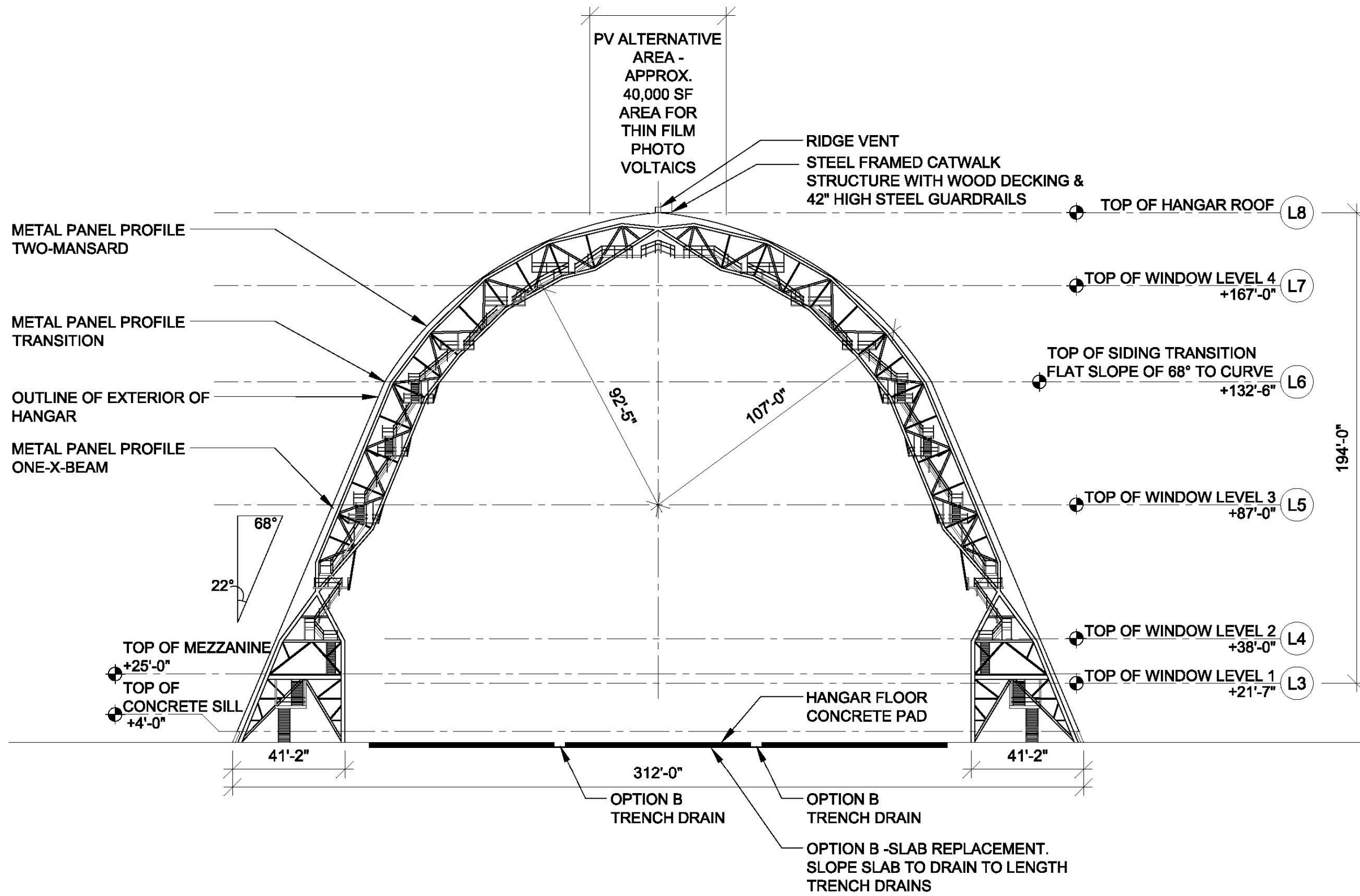

TYPICAL HANGAR CROSS-SECTION

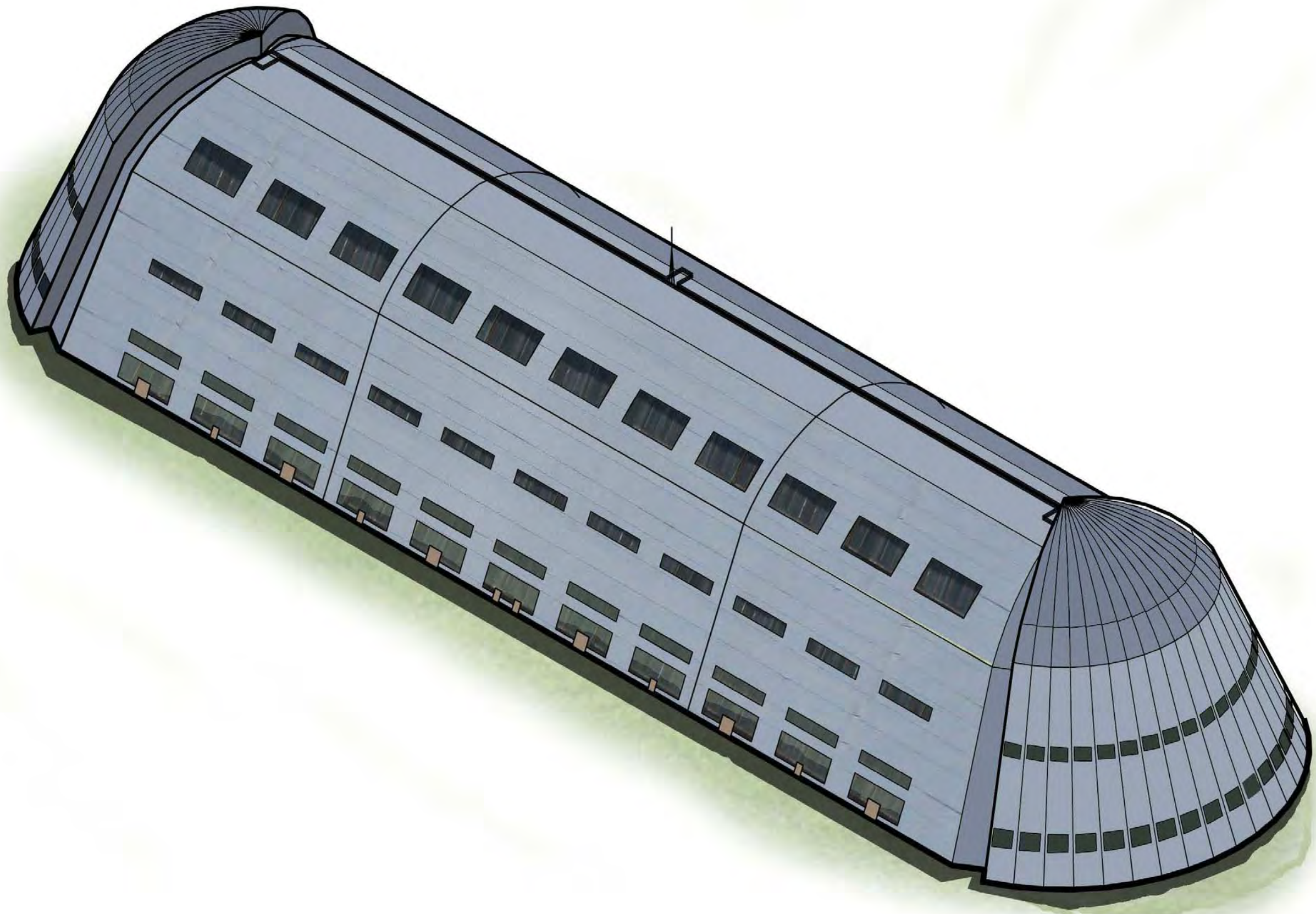

12.B Installation Details, Existing Condition

DWG: R:\001\60190653_J11004_Hangar One As-Built Documentation\500 CAD\A\Sheet\60190653-001-A7.01.dwg
 User: tbriggs DATE: Jul 18, 2011 9:33:53 am

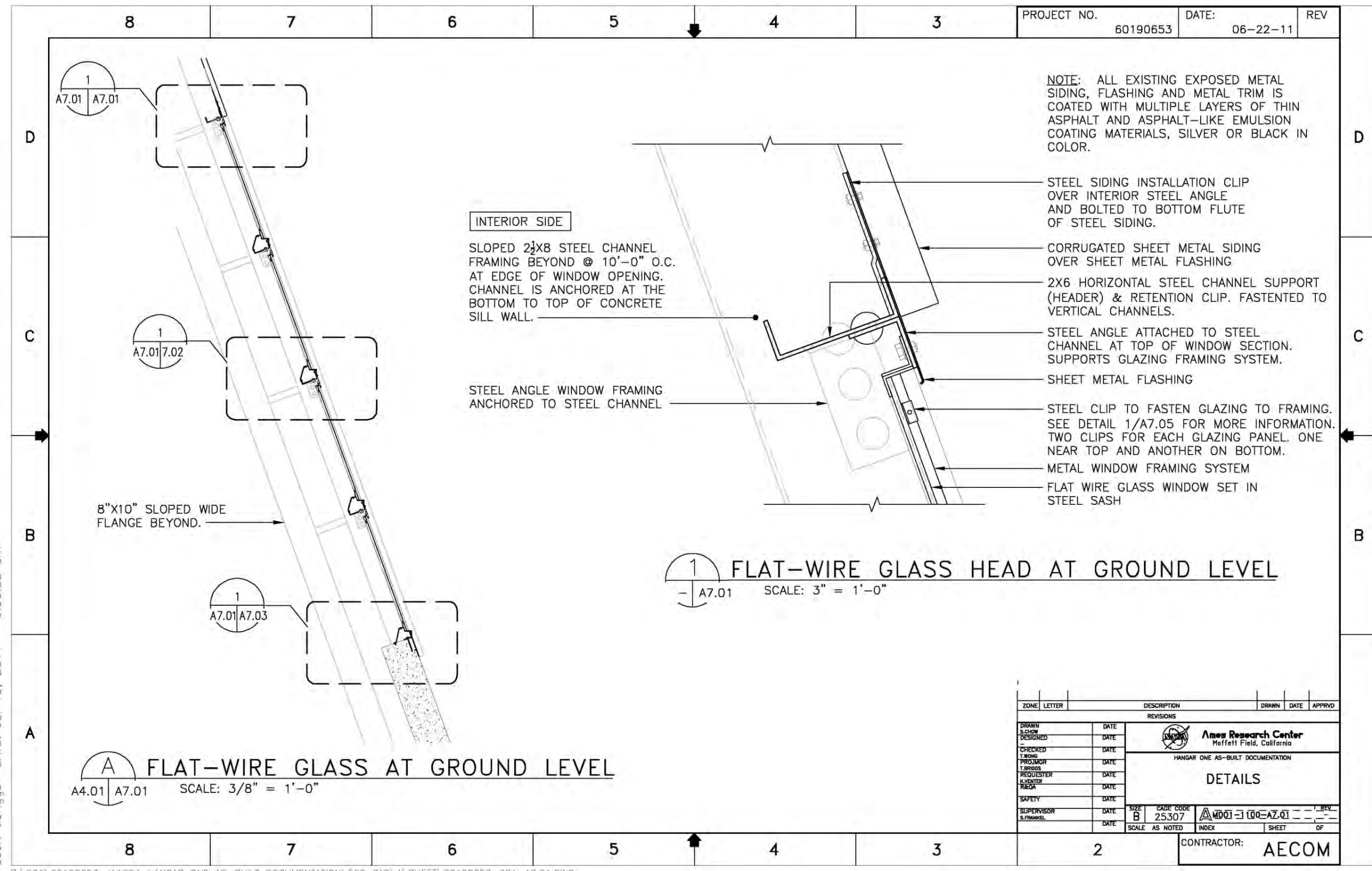

PROJECT NO.	DATE:	REV
60190653	06-22-11	

NOTE: ALL EXISTING EXPOSED METAL SIDING, FLASHING AND METAL TRIM IS COATED WITH MULTIPLE LAYERS OF THIN ASPHALT AND ASPHALT-LIKE EMULSION COATING MATERIALS, SILVER OR BLACK IN COLOR.

- STEEL SIDING INSTALLATION CLIP OVER INTERIOR STEEL ANGLE AND BOLTED TO BOTTOM FLUTE OF STEEL SIDING.
- CORRUGATED SHEET METAL SIDING OVER SHEET METAL FLASHING
- 2X6 HORIZONTAL STEEL CHANNEL SUPPORT (HEADER) & RETENTION CLIP. FASTENED TO VERTICAL CHANNELS.
- STEEL ANGLE ATTACHED TO STEEL CHANNEL AT TOP OF WINDOW SECTION. SUPPORTS GLAZING FRAMING SYSTEM.
- SHEET METAL FLASHING
- STEEL CLIP TO FASTEN GLAZING TO FRAMING. SEE DETAIL 1/A7.05 FOR MORE INFORMATION. TWO CLIPS FOR EACH GLAZING PANEL. ONE NEAR TOP AND ANOTHER ON BOTTOM.
- METAL WINDOW FRAMING SYSTEM
- FLAT WIRE GLASS WINDOW SET IN STEEL SASH

1
A7.01 | A7.01

1
A7.01 | 7.02

1
A7.01 | A7.03

1
A7.01

A
A4.01 | A7.01

FLAT-WIRE GLASS HEAD AT GROUND LEVEL

SCALE: 3" = 1'-0"

FLAT-WIRE GLASS AT GROUND LEVEL

SCALE: 3/8" = 1'-0"

ZONE	LETTER	DESCRIPTION	DRAWN	DATE	APPRVD
REVISIONS					
DRAWN	SCHW	DATE			
DESIGNED		DATE			
CHECKED		DATE			
PRODUCED		DATE			
T.BRIGGS		DATE			
REQUESTER		DATE			
K.VENTER		DATE			
REQA		DATE			
SAFETY		DATE			
SUPERVISOR		DATE			
S.FRANKEL		DATE			
SIZE		CAGE CODE			
B		25307			
SCALE		INDEX			
AS NOTED		A4.01 - 100-A7.01			
		SHEET			
		OF			
CONTRACTOR: AECOM					

R:\001\60190653_J11004_HANGAR ONE AS-BUILT DOCUMENTATION\500 CAD\A\SHEET\60190653-001-A7.01.DWG
 LAST SAVED BY: TLBRIGGS

DWG: R:\001\60190653_J11004_Hangar One As-Built Documentation\500 CAD\A\Sheet\60190653-001-A7.12.dwg
 User: tbriggs DATE: Jul 18, 2011 - 8:58:41 am

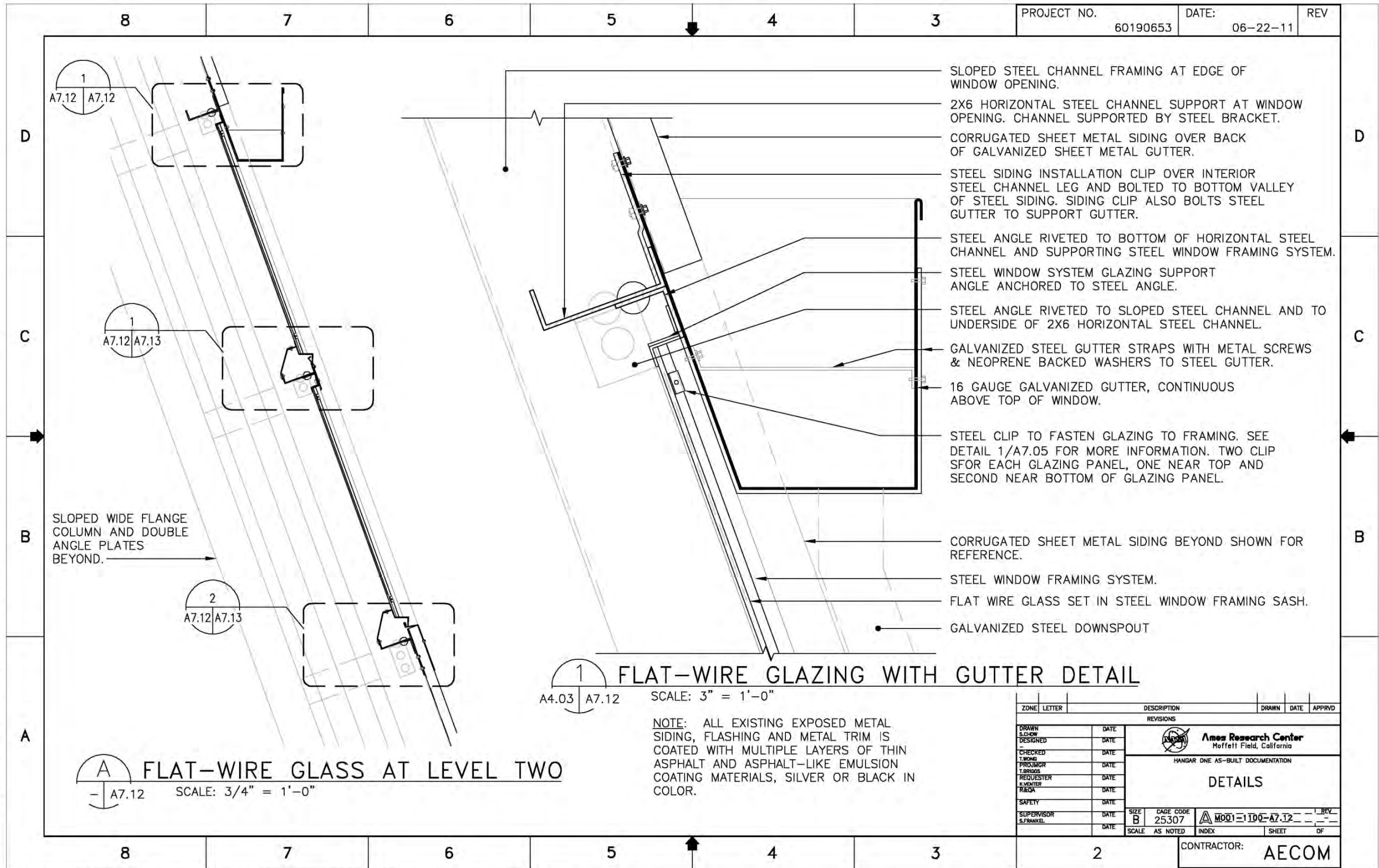

R:\001\60190653_J11004_HANGAR ONE AS-BUILT DOCUMENTATION\500 CAD\A\SHEET\60190653-001-A7.12.DWG
 LAST SAVED BY: TLBRIGGS

DWG: R:\001\60190653_J11004_Hangar_One As-Built Documentation\500 CAD\A\Sheet\60190653-001-A7.17.dwg
 User: tbriggs DATE: Jul 18, 2011 9:15:33 am

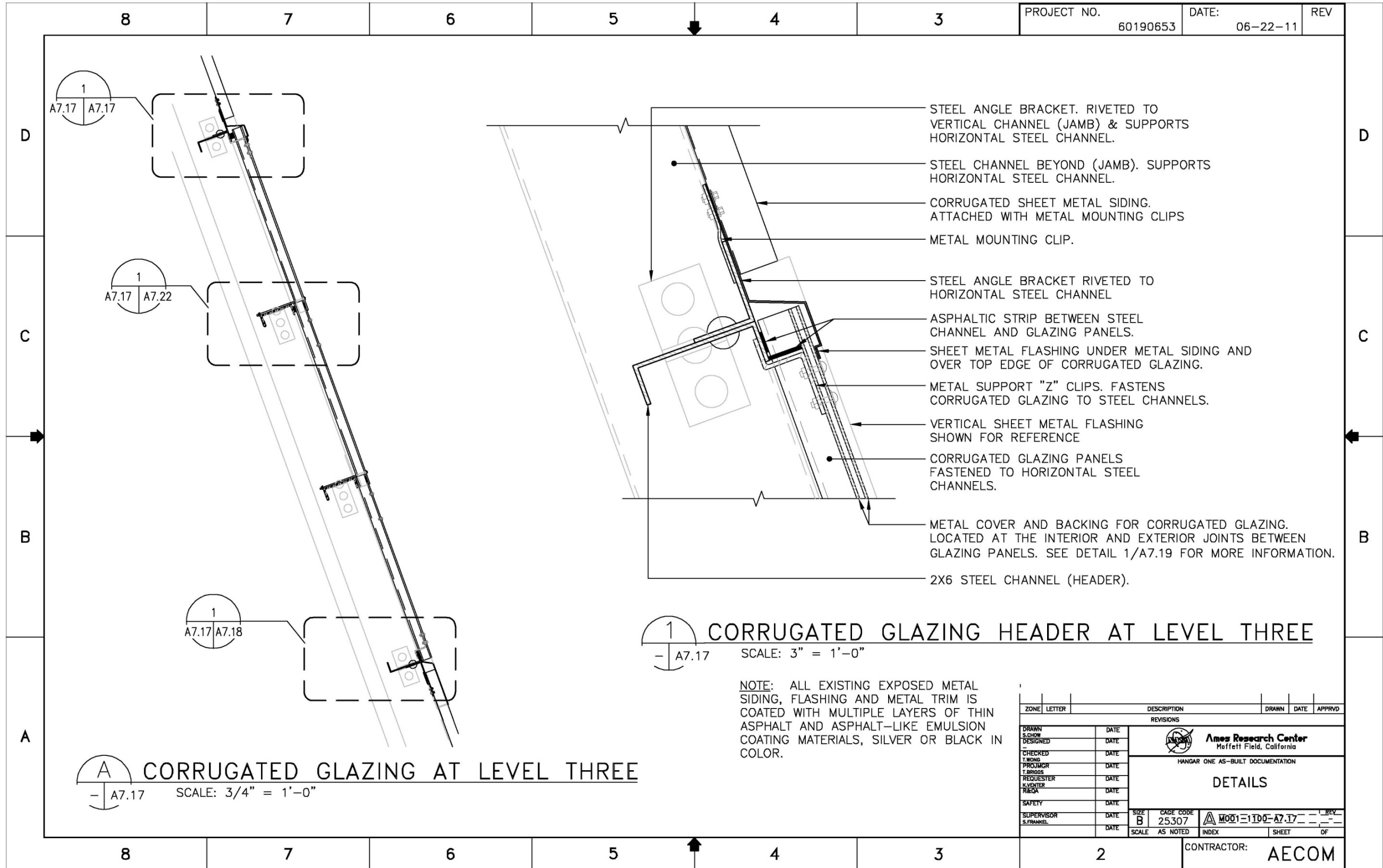

PROJECT NO.	60190653	DATE:	06-22-11	REV
-------------	----------	-------	----------	-----

1 CORRUGATED GLAZING HEADER AT LEVEL THREE
 - A7.17 SCALE: 3" = 1'-0"

NOTE: ALL EXISTING EXPOSED METAL SIDING, FLASHING AND METAL TRIM IS COATED WITH MULTIPLE LAYERS OF THIN ASPHALT AND ASPHALT-LIKE EMULSION COATING MATERIALS, SILVER OR BLACK IN COLOR.

ZONE	LETTER	DESCRIPTION	DRAWN	DATE	APPRVD
REVISIONS					
DRAWN	S.CHOW	DATE			
DESIGNED		DATE			
CHECKED		DATE			
T.WONG		DATE			
PROJECTOR		DATE			
T.BRIGGS		DATE			
REQUESTER		DATE			
K.VENTER		DATE			
RACDA		DATE			
SAFETY		DATE			
SUPERVISOR		DATE			
S.FRANKEL		DATE			

Ames Research Center
 Moffett Field, California
 HANGAR ONE AS-BUILT DOCUMENTATION
DETAILS

SIZE	B	CAGE CODE	25307	MO01-1100-A7.17	REV
SCALE	AS NOTED	INDEX		SHEET	OF

CONTRACTOR: **AECOM**

12.C Installation Diagrams & Conceptual Details

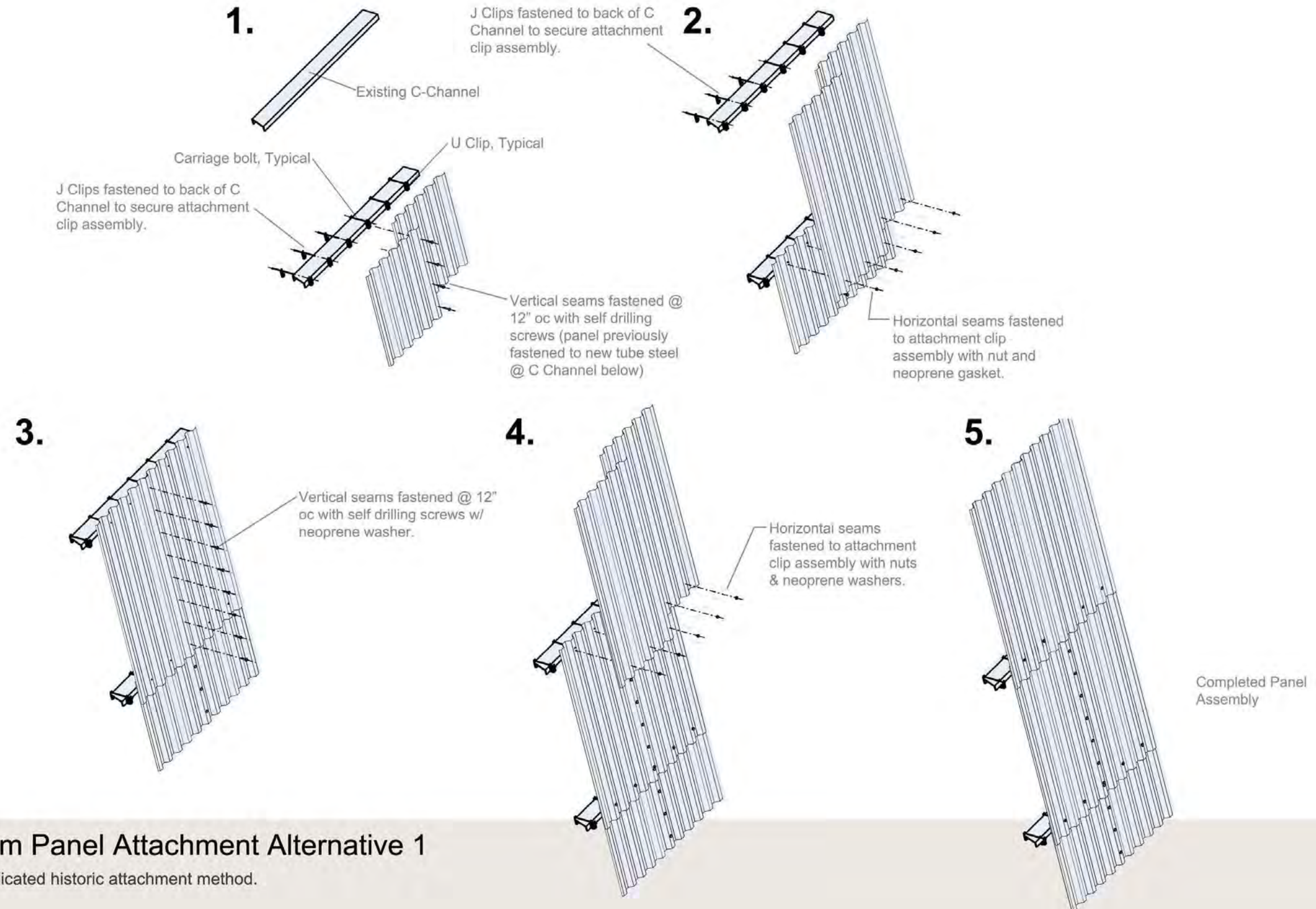

V-Beam Panel Attachment Alternative 1

Use of replicated historic attachment method.

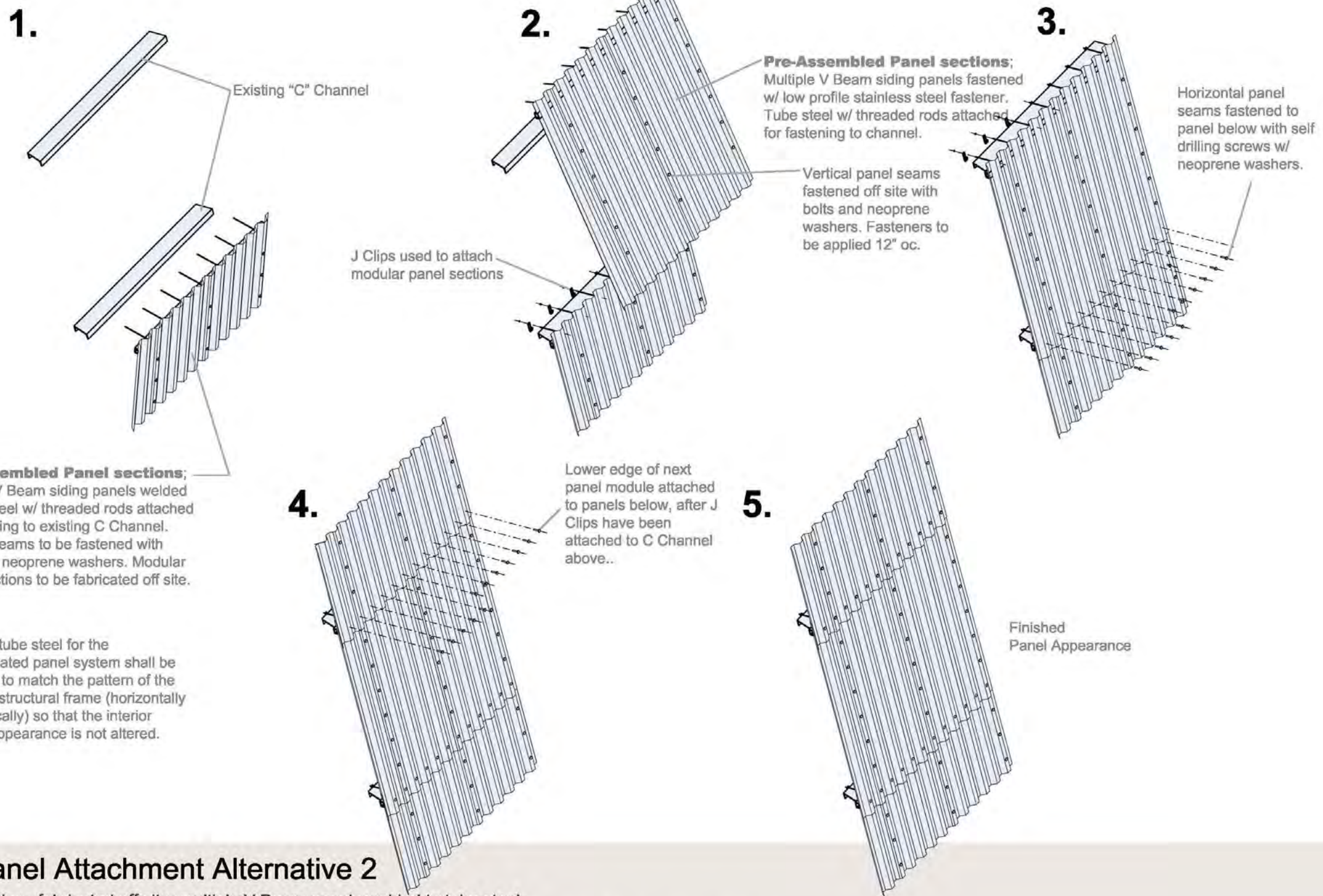

V-Beam Panel Attachment Alternative 2

Modular panel sections fabricated off site; multiple V Beam panels welded to tube steel, vertical seams fastened w/ bolts / neoprene washers. Panels fastened to existing structure with J Clips and threaded rod.

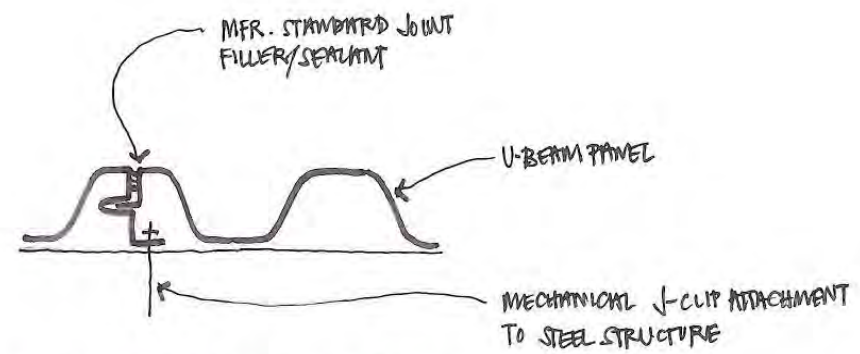

PANEL PROFILE ONE - V-BEAM

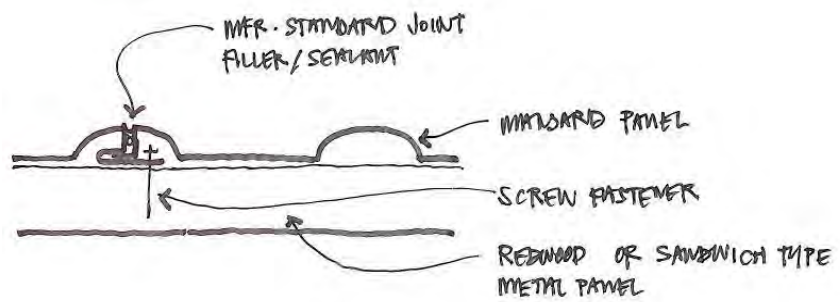

PANEL PROFILE TWO - MANSARD

CONCEALED FASTENER - METAL PANELS
CONCEPTUAL DETAIL SKETCH

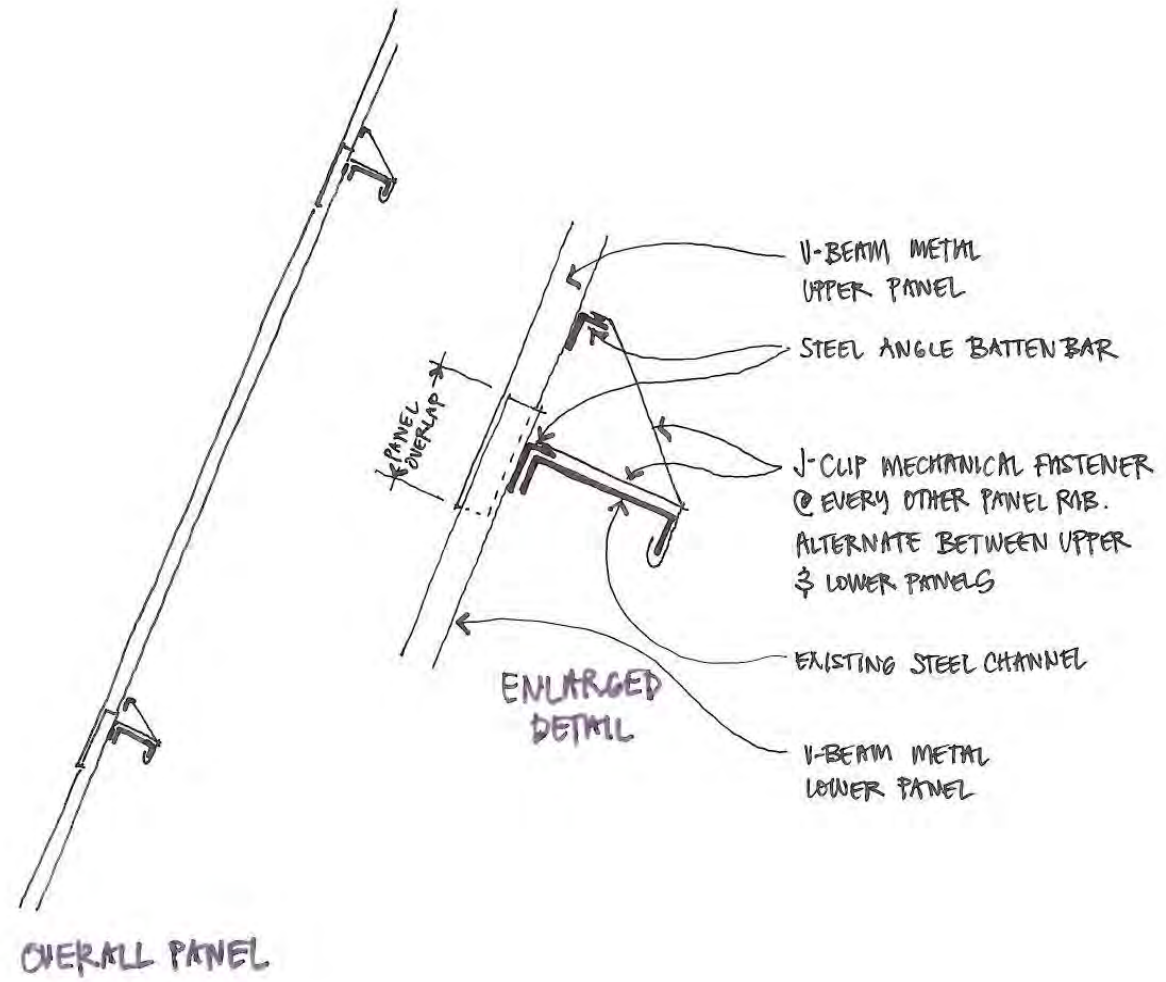

CONCEALED FASTENERS - METAL PANELS
CONCEPTUAL DETAIL SKETCH

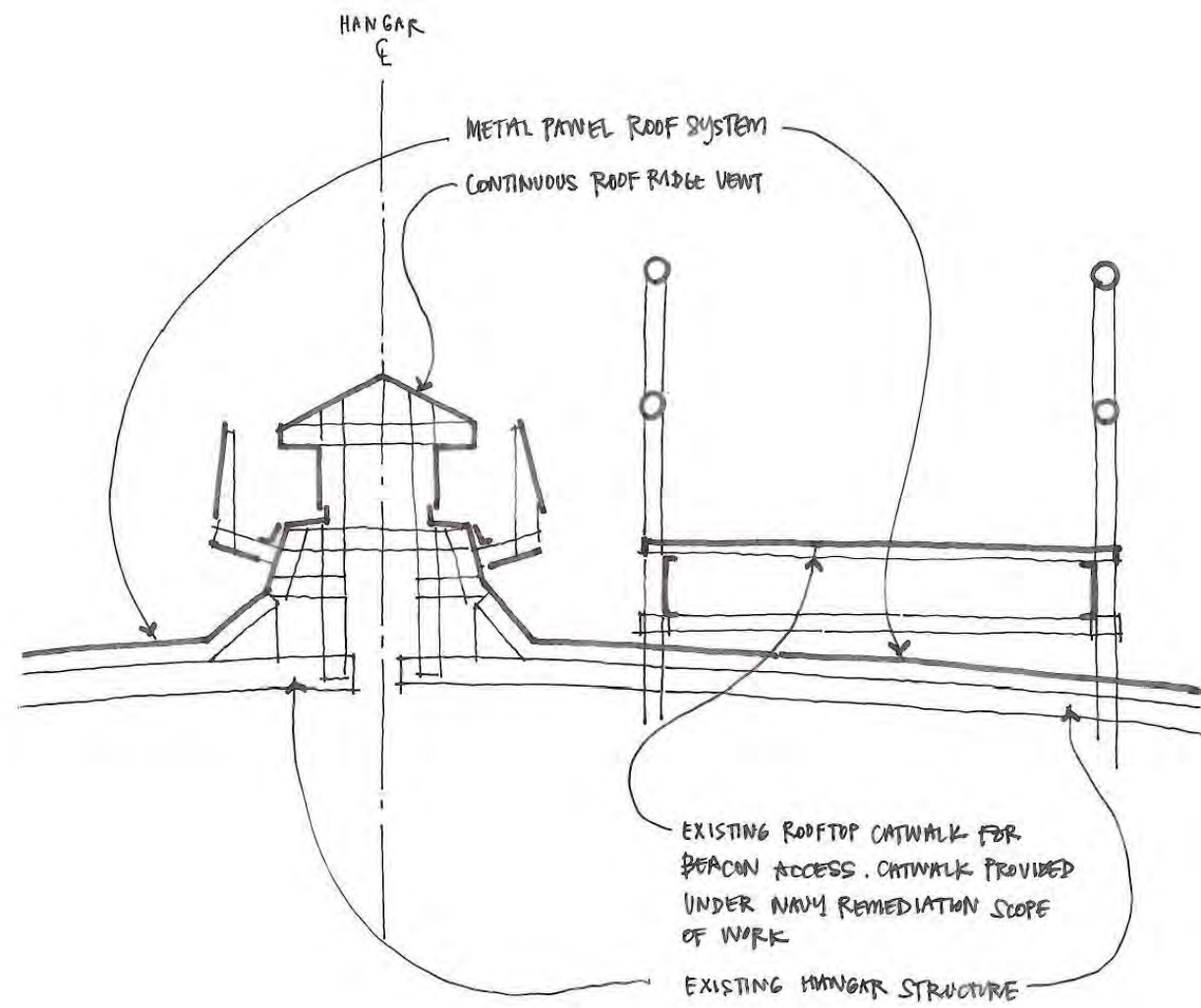

ROOF WALKWAY & RIDGE VENT
CONCEPTUAL DETAIL SKETCH

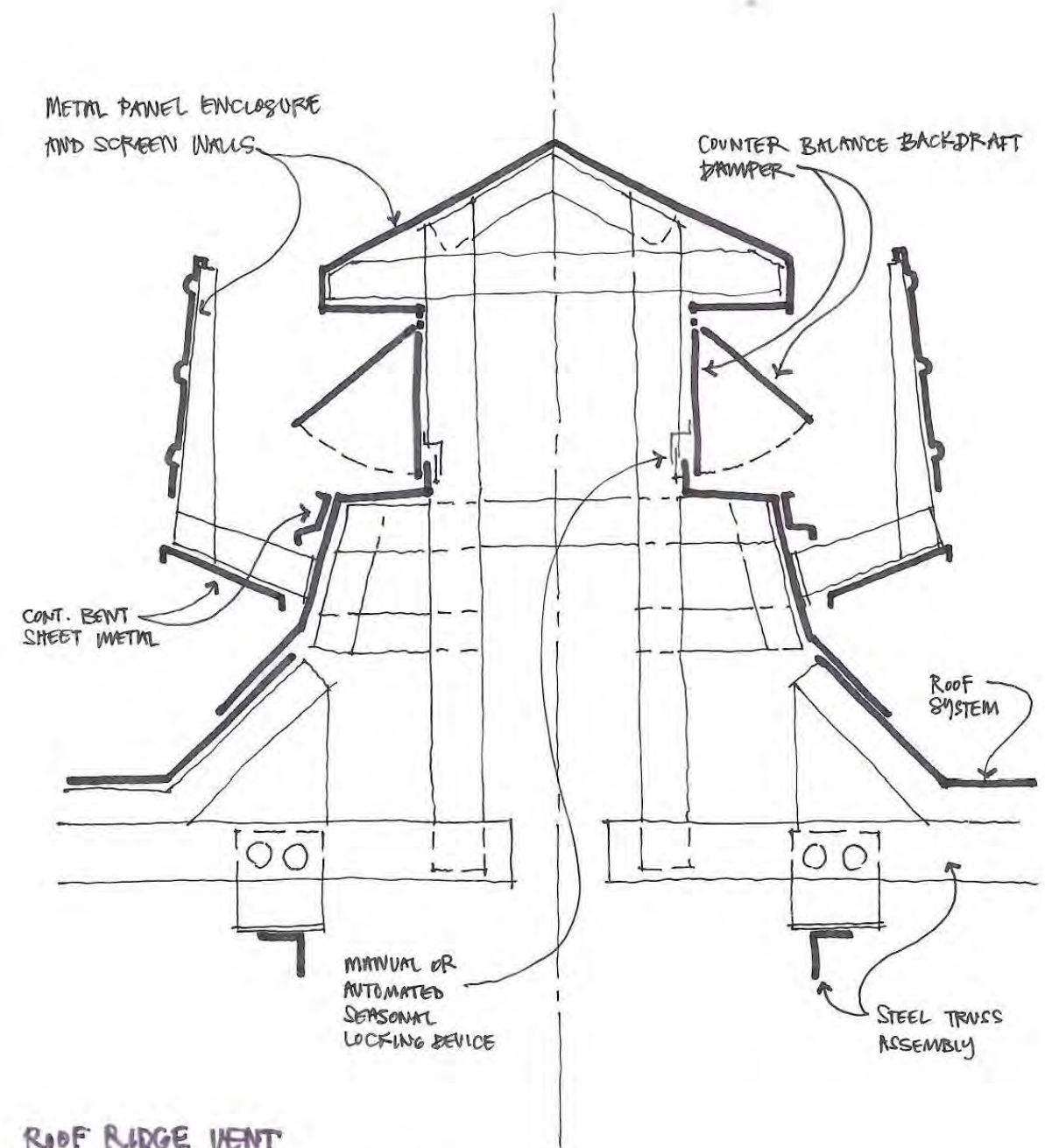

ROOF RIDGE VENT
CONCEPTUAL DETAIL SKETCH

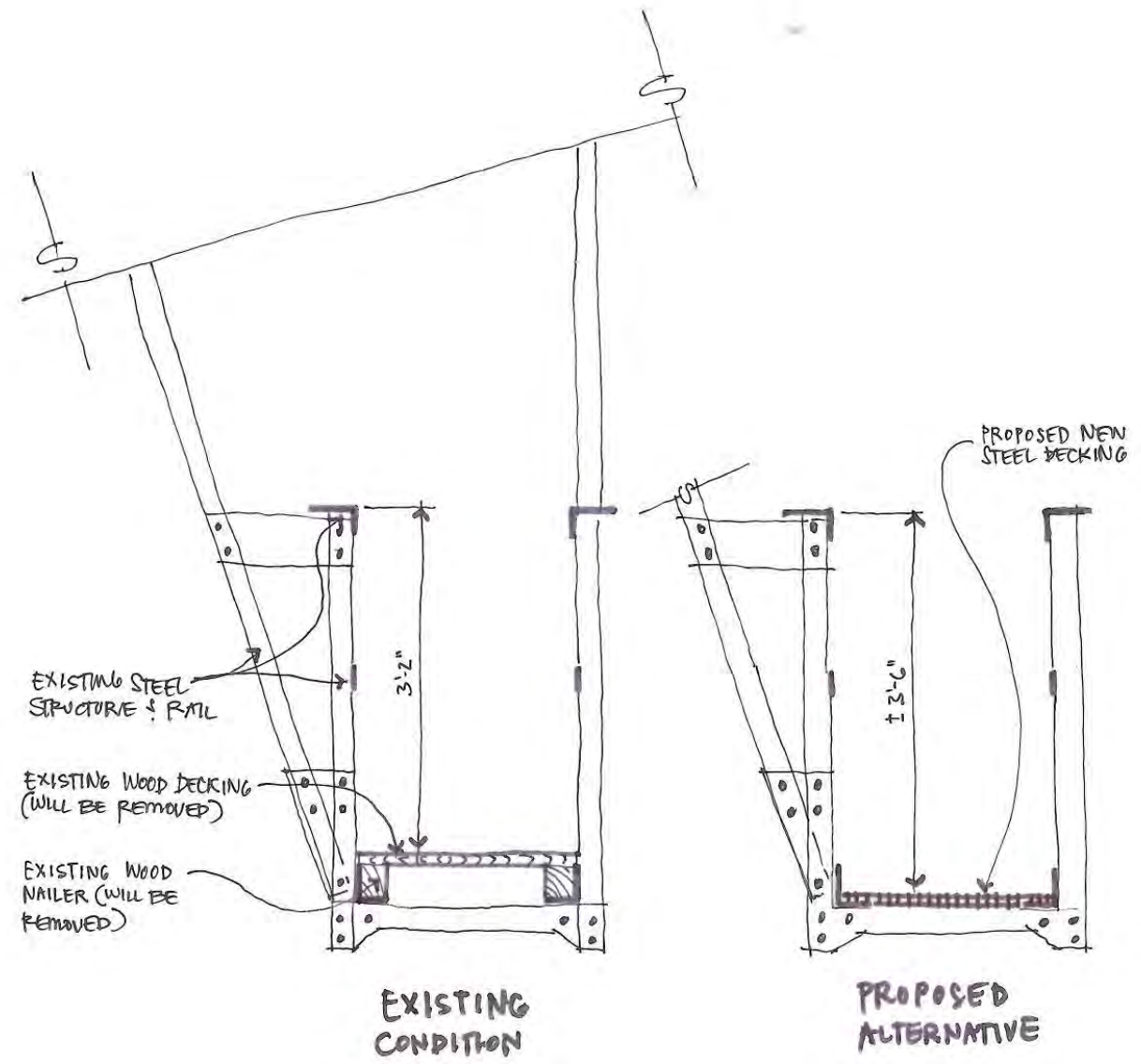

CATWALK RAIL HEIGHT IMPROVEMENT
CONCEPTUAL DETAIL SKETCH





Condition Assessment and Rehabilitation Plan Hangar One

for NASA Headquarters and
Ames Research Center, California

Volume 3
Appendices



Appendix A: Bibliography

- AECOM; Architectural Façade Study, June 18, 2011. *61 page study describing potential manufacturers and materials to provide metal panel and corrugated windows to be used in re-siding Hangar One*
- AECOM; As-Built Documentation, June 22, 2011. *110 pages of drawings and photographs detailing the existing condition of Hangar One prior to the start of the ongoing Navy Remediation Work*
- Exeltech; Field Summary Memorandum: Structural Analysis and Gravity, Seismic and Wind Vulnerability Study of IR Site 29, NAVFAC Contract # N62483-07-D-2006 0003, January 2008. *20 page report detailing missing structural brace members and the condition of existing members*
- Exeltech; Structural Analysis & Gravity, Seismic And Wind Vulnerability Study, NAVFAC Contract # N6243-07-R-2006, 2008. *131 page report detailing a seismic analysis and required retrofit details*
- Higley, Lloyd S.; Building The World's Largest Airship Factory and Dock, The Ohio State Engineer, January 1929.
- NASA Office of Audits; Hangar One Re-Siding Project, June 22, 2011. *28 page report regarding re-siding efforts and issues*
- Page & Turnbull, Inc.; Hangar One Re-Use Guidelines, August 24, 2001. *146 page report that includes a condition assessment and guidelines for potential re-use options for re-development of Hangar One*
- Original As-Built Drawings, Dates Vary. *Approximately 492 drawings covering the original construction of the hangar and subsequent modifications and additions.*

HAER (Historic American Engineering Report) Documents

- Hangar 1 Historic Engineering Record, #CA-335, *46 pages*
- Contemporary Photography of Hangar 1's Structure, *60 pages*
- Original Architectural Drawings of hangar 1, *17 pages*
- Restoration Drawings of Hangar 1, *18 pages*

Appendix B: Current Condition Survey

LOCATION	ELEMENT	MATERIAL	CONDITION	SIGNIFICANCE	NOTES & DESCRIPTION
Overall	Exterior Skin	Galbestos siding with metal core, silver paint coating. The galbestos contains asbestos.	Fair	Very Significant	Skin has a rough texture as a result of multiple coats of paint. Patches of rust throughout. Most abuse at 6' and below. Not completely weather proof. The exterior skin is currently being removed as part of the Navy Remediation Work.
Overall	Structure	Three hinged steel truss. Steel cross bracing, misc. framing and decks. Interior has concrete base, first floor.	Good	Very Significant	Seismic evaluation by Exeltech, July 2008, indicated that the structure is deficient in several areas. A new seismic analysis under the current building code is currently under way.
Overall	Roof	Build-up with wood decking.	Fair	Significant	Previous surveys indicate that roof has serious leaks. The only safe and permitted access to the roof is through the access door located on the east #8 catwalk between Bents 7 & 8. Access is strictly limited. Roof not accessed for this survey. The roof is being removed as part of the Navy Remediation Work.
Overall	Windows & Skylights	Metal and glass	Fair-Poor	Very Significant	Four rows of metal windows within each bay, set-up in a rhythmic vocabulary. Rust accumulation throughout. Lower windows at west elevation have been painted over. Many windows are broken. From the exterior it appears that windows have been randomly punctured to introduce ventilation to the interior. The windows and skylights are being removed as part of the Navy Remediation Work.
Overall	Hangar Door Stops	Concrete & miscellaneous material	Fair	Very Significant	One hangar door stop per door.
North	Hangar Doors	Steel framing, corrugated galbestos siding, and two rows of windows.	Fair	Very Significant	One door is inoperable.
South	Hangar Doors	Steel framing, corrugated galbestos siding, and two rows of windows.	Fair	Very Significant	Operable. Doors open at 12 feet per minute.
East Side. Between Column Line 8 & 9	Overhead Doors	Metal and glass	Fair	Contributing	The window framework in this bay makes up the pair of overhead doors. The aesthetic of these doors work well within the context of the hangar. North Door is permanently held open with Columns. A permanent metal fence was installed at this opening for security reasons.

Throughout	Roll-up Doors	Metal	Fair	Contributing	Within the framework of the lower set of windows. Three overhead doors on the east side of the building and five overhead doors on the west side.
Exterior, Throughout	Doors	Metal	Fair	Varies between contributing and non-contributing. Most doors are within original concrete framework, which is significant. This concrete framework is shown most clearly in the top photograph, Appendix B/p.10.	Doors are industrial style, however, there are several different styles. Bay 7-8 East side has an example of a successful door. The door is within the window framework as well as within the original, typical concrete framework designed for the doors. This is the only door that has a canopy for weather protection. The canopy is of the industrial aesthetic and fits very well within the structural framework.
Throughout	Transformer Room Doors	Metal	Fair	Significant	Total of six doors. Approx. 5'-6". Louvered at the lower half, three vision panels at the top. These doors are original but do not have the required height for an exit door. These doors provide single access to the transformer rooms from the exterior only.
South Half	New Exit Doors	Wood	Good	Not Contributing	Placed in newly created 1-hr corridors. Aligned with roll-up doors. Not visible from the exterior when the roll-up doors are closed.
Overall	Floor	Concrete	Fair	Contributing	Some of the original floor remains. However, a significant portion of the floor has been altered. This is due to the addition of offices space that has been built out in the high bay area as well as repair work to make the floor even. The floor at the northern end contains lead dust. The rails, tie-downs for the dirigible, and cross over track make up part of the floor hangar. these are significant. There are two sunken areas in the hangar floor where the concrete is severely cracked. The condition of the soil under the cracked areas is unknown.
Longitudinal Midpoint of Hangar	Tunnels Utility Tunnel	Concrete	Not Known	Contributing	5'-6" wide by 7'-2" high with 8" thick concrete walls. The tunnels were not accessed for this survey. The tunnels connect the hangar to the boiler room, Bldg. Ten.
Overall	Drainage Grate	Metal	Fair	Contributing	Interior condition not known.
Interior	Sheet Steel Paneled Walls	Sheet Steel & Gypsum Board	Good	Very Significant	Metal walls are panels that are made up of a composite: gypsum board sandwiched between two metal panels. The panels interlock like a puzzle, hence allowing quick assembly. The pieces are bolted together. There are several metal slider doors within these metal walls. The slider doors are significant. Interior walls have been removed as part of the Navy Remediation Work

Interior	Catwalks	Steel	Good	Very Significant	Closed off from most public access due to nonconformance to code. There are 8 catwalks on the east side of the hangar and 8 catwalks on the west side of the hangar. The wood flooring on the catwalks will be removed as part of the Navy Remediation Work.
Interior	Stairways	Steel	Good	Significant, most locations	There are 3 sets of access stairways to the catwalks and the roof on each side of the hangar. The stair handrail and rise-run do not currently meet OSHA requirements.
West. Between Column Lines 7 & 8	Elevator	Metal	Fair	Very Significant	Located at the longitudinal mid-point of the structure. Runs up along the arched structure. The elevator has been removed and all wood along the elevator tracks will be removed.
East Side. Between Column Line 7 & 8	Elevator	Metal	Missing	Very Significant	Only shaft and tracks remain. Tracks and shaft similar to west side. The wood ties at the elevator tracks will be removed.
Below Roof Deck	Break Room			Significant/ Contributing	Possibly added after original construction. The only safe and permitted access to the roof is through the access door located on the east #8 catwalk between Bents 7 & 8. Access is strictly limited. Not accessed for this survey.
High Bay, Open Area	Post WWII Offices and Classrooms	Misc. Type V building materials, asbestos containing materials	Fair	Non-Contributing	Added as classrooms and offices. Not inherent historical value. The interior rooms have been removed as part of the Navy Remediation Work.
Third Floor, East Side. Between Column Lines 1 & 3	Cork Room	Walls have plaster composition on the exterior and cork on the interior, Oak Floors	Fair	Very Significant	Used to cure the dirigible gas bags and cells. Cork on the wall is about 6" thick. The interior rooms have been removed as part of the Navy Remediation Work.
First & Second Floor, North-East side, Between Column Lines 5 & 7	Operations Office	Perimeter wall is hollow, clay tile and sheet steel panels. Interior walls are wood and gypsum board.	Fair	Significant/ Contributing	Perimeter walls are original and significant. Interior space altered. Bay window added after original construction. The interior rooms have been removed as part of the Navy Remediation Work.
First & Second Floor, South-East side, Between Column Lines 12 & G	Office Space	Perimeter wall is sheet steel panels. Interior walls are wood & gypsum board.	Poor	Significant/ Non-contributing	Perimeter walls are significant. Interior space is heavily altered space. The interior rooms have been removed as part of the Navy Remediation Work.

1st Floor, Throughout	Work Shops	Perimeter walls are sheet steel panels. Interior walls are wood & gypsum board	Fair	Perimeter wall is significant. Interior space is non-contributing	Interior space is heavily altered. The interior rooms have been removed as part of the Navy Remediation Work.
2nd Floor Throughout	Office Space	Perimeter walls are sheet steel panels. Interior walls are wood & gypsum board	Fair	Perimeter wall is significant. Interior space is non-contributing	Interior space is heavily altered. The interior rooms have been removed as part of the Navy Remediation Work.
2nd Floor, West Between Column Lines 13 & 14	Office	Walls are wood & gypsum board, tile floor	Poor	Non-Contributing	Small, original office space. The interior rooms have been removed as part of the Navy Remediation Work.
Throughout	Transformer Rooms	Concrete Walls	Unknown	Significant	Part of original structure.
West Side, between Column lines 1 & 3	Toilet Room #1	Concrete Walls	Fair-Poor	Contributing	Some of original fixtures.
East Side, between Column lines 12 & 14	Toilet Room #6	Concrete Walls	Fair-Poor	Contributing	Some original fixtures.
Original @ ceiling	Lighting	Metal fixture with glass lens	Fair	Contributing	The lights are not operable. Light switches associated with these lights are contributing as well.
South Bay	PWWII Lighting	Metal fixture with open bulb.	Good	Non-Contributing	Added to the southern half of the hangar for aircraft operations.
Throughout	Explosion-Proof Lights	Metal and Glass	Good	Very Significant	Attached to the steel structure of the hangar. Some are operable.
Throughout	Crane Cabs	Metal with wood seats	Unknown	Very Significant	The cranes have been removed as part of the Navy Remediation Work.
North End of Hangar	Cantilevered Cradles	Wood	Fair	Very Significant	All wood members are being removed as part of the Navy Remediation Work.
East Exterior of Hangar	Plaques	Metal	Good	Non-Contributing	California Historical Civil Engineering Landmark Plaque & Memorial Plaque. While these are not significant, they point to the historical significance of the hangar.

Note: This condition survey originally appeared in Re-use Guidelines Report by Page & Turnbull, Inc dated 24 August 2001. It has been modified to match the current site conditions.

Appendix C: Page & Turnbull Code Issues Matrix

Issue	Existing Conditions	Proposed Modifications	Previous Recommendations	Page & Turnbull Response	State Historic Building Code
<p>Building Construction Type</p>	<ul style="list-style-type: none"> Type V, Non-Rated Building. Several of the Post-WWII office areas are sprinklered. 	<p><u>Short-term:</u></p> <ul style="list-style-type: none"> None <p><u>Long-term:</u></p> <ul style="list-style-type: none"> Make modifications as required by Building Officials. 	<p><u>Kaiser & Folsom Report:</u></p> <ul style="list-style-type: none"> Removal of all wood frame structures within the hangar. Applied fireproofing material per Table 6-A to elevation of 25' above the highest roof deck. Reconstruct offices and classrooms as Type 1 Fire-Rated construction. <p><u>DMJM:</u></p> <ul style="list-style-type: none"> Identify alternative methods of achieving code-compliance for fire-resistive construction through substitution of traditional fireproofing with non-traditional coatings or alternate configurations of sprinkler systems. All new construction will meet the requirements of the Uniform Building Code. 	<ul style="list-style-type: none"> Hangar One to remain Type V, Non-Rated Construction. Removal of altered office space and Post-WWII construction. Preservation of selected rooms and wall assemblies with historical merit. Provide all new construction with Type I, Fire-Rated construction. Enable new construction to be reversible without impact to historic fabric. 	<p>8-803 Continued use of existing nonstructural historic materials not meeting regular code requirements allowed, provided that public health and life-safety hazards are mitigated, as approved by the enforcing agency.</p> <p>8-402 Fire resistance requirement for existing exterior walls and existing opening protection may be satisfied when an automatic fire-extinguishing system designed for exposure protection is installed.</p> <p>8-403 Existing nonconforming materials used in interior wall and finishes may be surfaced with an approved fire retardant to increase the rating of the natural finish to within reasonable proximity of the required rating. <i>Exception: When an approved automatic sprinkler system is provided throughout the building, existing finishes need not be fire retardant.</i></p> <p>8-408 Wooden roof materials allowed where fire resistance is required if treated with fire-retardant treatments to achieve an equivalence to a Class C fire-resistive rating, or as otherwise permitted on a case-by-case basis.</p> <p>8-409 Every historical building which cannot be made to conform to the construction requirements specified in the regular code for the occupancy or use, and which constitutes a distinct fire hazard shall be deemed to be in compliance if provided with an approved automatic fire-extinguishing system.</p>
<p>Structure</p>	<ul style="list-style-type: none"> Construction is steel, wood, concrete and transite with a metal roof covering on the main hangar. <p>Seismic evaluation by Rutherford & Chekene, December 1984:</p> <ul style="list-style-type: none"> Almost all of the members were determined to be adequate, stress was below the allowable limit assumed at the time. Two places need reinforcing: the top of the arches and the connection at the lower pin where the arch connects to the "A" frame. 	<p><u>Short-term:</u></p> <ul style="list-style-type: none"> None <p><u>Long-term:</u></p> <ul style="list-style-type: none"> Dependent on updated Structural Survey. 	<p><u>DMJM:</u></p> <ul style="list-style-type: none"> Upgrade of the 1984 Seismic Report based on prevailing code. New report to consider wind factor due to building height and site conditions. New interior construction should be self-supporting and seismically compliant to current code. Make the existing Hangar One structure seismically safe by strengthening and adding lateral bracing of the structure. 	<ul style="list-style-type: none"> Recommend that the structural strength of the building be thoroughly evaluated by structural engineer with expertise in historic structures. Structural upgrades limited to correct unsafe conditions and should be sensitive to the original structure. New Non-historical additions and alterations to comply with current code. These shall be structurally independent and reversible from the original structure. 	<p>8-102 Work to remedy the building shall be limited to the correction of the unsafe (life-threatening) conditions, and it shall not be required to bring the entire building in compliance with regular code.</p> <p>8-703 Every structure or portion of a structure to be evaluated for structural capacity under this code shall be surveyed for structural conditions by an architect or engineer knowledgeable in historical structures. The survey shall document deterioration or signs of distress.</p> <p>8-705 Where no distress is evident, and a complete load path is present, the structure</p>

Issue	Existing Conditions	Proposed Modifications	Previous Recommendations	Page & Turnbull Response	State Historic Building Code
Structure (con't.)					<p>may be assumed adequate by having withstood the test of time if anticipated dead and live loads will not exceed those historically present. Any unsafe conditions in the lateral-load-resisting system shall be corrected, or alternative resistance shall be provided.</p> <p>8-706 The forces used to evaluate the structure for resistance to wind and seismic loads need not exceed 0.75 times the seismic forces prescribed in the 1995 edition of the CBC. Reasonably equivalent standards may be used on a case-by-case basis when approved by the authority having jurisdiction.</p>
Electrical, Plumbing, Mechanical	<p><u>Mechanical:</u></p> <ul style="list-style-type: none"> There are no fire dampers installed in the ductwork . <p><u>Electrical:</u></p> <ul style="list-style-type: none"> According to the DMJM Preliminary Survey, the Electrical System is marginally under-rated for load assumptions. A more in-depth electrical survey is needed. Unsafe, open wiring in some areas, thus creating unsafe conditions. <p><u>Plumbing:</u></p> <ul style="list-style-type: none"> The building has insufficient sanitary facilities. 	<p><u>Mechanical:</u></p> <ul style="list-style-type: none"> New HVAC planned. <p><u>Electrical:</u> DMJM Preliminary Survey (p. 14):</p> <ul style="list-style-type: none"> No electrical conditions that would prevent the re-use of Hangar one as a public building. It is assumed that up-grades will be required. Existing electrical will be able to handle upcoming needs with minimal upgrades. <p><u>Plumbing:</u> <u>Short-term:</u></p> <ul style="list-style-type: none"> Needs met through portable facilities. 	<p><u>Mechanical:</u> <u>DMJM:</u></p> <ul style="list-style-type: none"> All new penetrations through hangar skin to be carefully planned and approved by NASA and the California State Historical Preservation Office (SHPO). <p><u>Electrical:</u> Kaiser & Folsom: Grounding needs to be upgraded.</p> <p><u>Plumbing:</u> Kaiser & Folsom: Provide minimum facilities for each occupancy, as required by Appendix C 94 UPC and Chapter 29 UBC</p>	<p>Survey existing systems to identify any safety deficiencies that could lead to a fire. The mechanical, electrical and plumbing systems which do not contribute to the historic character should be removed if they create a life/safety hazard.</p> <ul style="list-style-type: none"> Design new exposed equipment and feeds to integrate with the building's industrial vocabulary. New equipment should be understood as new construction. New penetrations through hangar skin to be carefully planned and approved by NASA and SHPO. Investigate use of tunnel for possible placement of mechanical, plumbing equipment. Add sufficient plumbing fixtures to bring Hangar into compliance employing space planning that is sensitive to the historic plan of the hangar. Historic explosion-proof light fixtures attached the main structure to remain. Explosion-proof light fixtures in the Cork Room to remain. Preserve, if feasible, original light fixtures hung from hangar structure. Historic electrical outlet receptacles to remain. Preserve historic restrooms, see Diagram A. 	<p>8-901 Historic buildings are exempted from compliance with energy conservation standards. New appliances or equipment will be code compliant.</p> <p>8-902 Ventilation systems shall be installed so that no safety hazard is created.</p> <p>8-902, 8-903, 8-904: For Mechanical, Plumbing and Electrical, the SHBC states, "Existing systems which do not, in the opinion of the enforcing agency, constitute a safety hazard may remain in use. The enforcing agency may approve any alternative to these regulations which achieves reasonably equivalent life safety."</p> <p>8-903 New, non-historic materials shall be code compliant. The enforcing agency shall accept alternative materials which do not create a safety hazard where their use is necessary to maintain the historical integrity of the building.</p> <p>8-904 Where an equipment grounding conductor does not exist and, in the opinion of the enforcing agency, it is impracticable to connect an equipment grounding conductor to the grounding electrode system, receptacle convenience outlets may remain the non-grounding type. Receptacle outlet spacing and other related distance requirements shall be waived or modified if determined to be impracticable by the enforcing agency.</p>
Fire/Life Safety Allowable Height	<p>Maximum allowable height is 40', Hangar One is 194' in height. Maximum allowable stories for Hangar is 1, for the Office areas, it is two.</p>	<p>The existing building will remain 194' high, exceeding the maximum allowed per UBC Table 6-A.</p>	<p>Kaiser & Folsom: There are no exceptions that may be used to increase the allowed height of the building, a waiver would be required for this item.</p>	<ul style="list-style-type: none"> Reference SHBC 8-302.5 to obtain height waiver. Exceptional height of Hangar One is an integral part of the historic character of the building. 	<p>8-302.5 The maximum height and number of stories of a historical building shall not be limited because of construction type, provided such height or number of</p>

Issue	Existing Conditions	Proposed Modifications	Previous Recommendations	Page & Turnbull Response	State Historic Building Code
Access & Egress	<ul style="list-style-type: none"> Maximum travel distance for unsprinklered building is 200 ft. Maximum travel distance for a sprinklered building is 250 ft. Office space on second and third floors do not have compliant access and egress. These offices have been closed and access to them is restricted. <p><u>North Half of Hangar:</u></p> <ul style="list-style-type: none"> Closed to the public. Overall shortage of complying exits. Poor access to exits, especially from office areas. Poor signage. No emergency lighting. <p><u>South Half of Hangar (Event Area):</u></p> <ul style="list-style-type: none"> Five ground exits available. Emergency light in all exit corridors. Visibility of access to exits from within event area is not optimal. 	<p><u>Short-term:</u></p> <ul style="list-style-type: none"> Modifications will involve primarily the south half of hangar. Employ existing exiting system for short-term events as approved by Fire Marshall. No proposed upgrades in the short term. New exit will be constructed on west side of hangar, between column lines 11 and 12. The exit at the museum entrance will be upgraded from 3 feet in width to 4 feet in width. <p><u>Long-term:</u></p> <ul style="list-style-type: none"> Modifications will involve entire hangar. The overall shortage of complying exits with all proposed occupancies will be addressed. Long-term upgrades based on reuse recommendations. Sprinkle building. 	<p>Kaiser & Folsom: Do not recommend increasing travel distance due to the proposed new education, assembly and business occupancies.</p> <p>Each Occupancy type to have its own requirements for number of exits and location of exits.</p> <p>A detection, alarm and voice notification system shall be required as per NFPA 101 Section 9-3.4.</p> <p>Since Hangar 1 will be considered as an A-1 Occupancy, the hangar is required to have a main exit capable of exiting a minimum of 50% of the total occupant load. It is suggested that the main exit be located on the east side of the building that is typically used as the main entrance. It is also suggested that the large overhead door that is directly south of the entrance be reopened to provide this exit width.</p>	<ul style="list-style-type: none"> Short-term use: continue to use the Hangar Doors as emergency exit as required and continue to use new code-complying exits. Work with NASA Bldg. enforcing agency to formulate access and egress strategy to meet intended life & safety standards. Use existing exits when possible to avoid additional alterations to the building. Explore "co-equal" entrances in order to evenly distribute the width of the total exit path around the perimeter of the building. Short-term use: continue to use the overhead doors on the east side as the main entrance to the hangar. Long-term use: main entrances should be designed keeping the site master plan design in mind. Add new exits to serve areas of high occupancy and upper floors as required. Design a very clear and efficient system of egress to not only compensate for the size but also bring the level of safety up to the equivalency of a completely code conforming building. Egress design to be enhanced via state of the art signage, alarm system and annunciation systems. Location and design of new exits defer to the building aesthetic. Place new exits where the metal framed windows are located. New penetrations should be reviewed by building officials, using guidelines set by the State Historic Building Code and this report. See "Common Considerations", Example 1. All new construction to meet code standards for safe egress. Replace non-historic doors that are non-complying with code-complying doors. 	<p>stories does not exceed that of its designated historical design.</p> <p>8-410.2 An automatic fire-extinguishing system shall not be used to substitute for or act as an alternative to the required number of exits from any facility.</p> <p>8-501.1 These regulations require enforcing agencies to accept reasonably equivalent alternatives to the means of egress requirements in the regular code.</p> <p>8-502.1 Exits shall conform or be made to conform to the provisions of the regular code.</p> <p>Exceptions:</p> <ul style="list-style-type: none"> New fire escapes and fire escape ladders which comply with Section 8-502.2 shall be acceptable as one of the required means of egress. The enforcing agency shall grant reasonable exceptions to specific provisions covered under applicable regulations where such exceptions will not adversely affect the life safety intended. In lieu of total conformance with existing exiting requirements, the enforcing agency may accept any other condition which will allow or provide for the ability to quickly and safely evacuate any portion of a building without undue exposure and which will meet the intended exiting and life safety stipulated by these regulations. Existing previously approved fire escapes and fire escape ladders shall be acceptable as one of the required means of egress provided they extend to the ground and are easily negotiated, properly signed and in good working order.
Maximum Allowable Area	<ul style="list-style-type: none"> Maximum allowable for Type V-N "Hangar" is 5,100 S.F., 1994 UBC. For B occupancy, the maximum allowable is 8,000 S.F., 1994 UBC With its current classification of B-2 and B-3, Hangar One exceeds all maximum allowable area even with 	<p><u>Possible Occupancies:</u> A-1, A-2, A-2.1, A-3, & B-2, E-1 & E-2. Building Officials are recommending A-1 because it is the most stringent.</p> <p><u>For a type A-2.1 Occupancy:</u></p> <ul style="list-style-type: none"> "A" occupancy not permitted for Type 	<p><u>Kaiser & Folsom:</u> Recommendation that the building not be allowed to be used as A-2.1 (1994 UBC) or B-2 (1967 UBC) Occupancy without major modifications. These include:</p> <ul style="list-style-type: none"> Remove wood frame structures from inside hangar 	<p><u>Long-term:</u></p> <ul style="list-style-type: none"> Sprinkler the building to eliminate allowable area limitations. The Post WWII offices within the open area are not historical and should be demolished. The sprinkler system planned for long-term use is phased to take care of short-term needs and 	<p>8-302.2 The use or character of the occupancy of a historical building may be changed from its historic use or character provided the building conforms to the requirements applicable to the new use or character of occupancy as set forth in this code. Such change in occupancy</p>

Issue	Existing Conditions	Proposed Modifications	Previous Recommendations	Page & Turnbull Response	State Historic Building Code
	<p>allowed increases.</p>	<p>V, Non-rated construction.</p> <ul style="list-style-type: none"> Construction type for "A" must be Type 1 or Type 2 Fire Resistive. For unlimited area, hangar must be Type 1 Fire Resistive construction. <p><u>For B Occupancy:</u> Maximum area limitation: 8,000 sq. ft. Even with allowable increases (the total allowable can be brought up to 64,000 S.F.), Hangar One is still not in compliance.</p> <p><u>For E-1 or E-2 Occupancy:</u> Table 5-B: Maximum Area of 9,100 S.F. With allowable increases, the total for E occupancy is 36,400 S.F.</p> <p><u>Mixed Occupancies:</u> UBC Section 504.3 When a building houses more than one occupancy, the area of the building shall be such that the sum of the ratios of the actual area for each separate occupancy divided by the total allowable area for each separate occupancy shall not exceed 1.</p>	<ul style="list-style-type: none"> Provide automatic sprinkler system throughout the building. Apply fireproofing material to provide min. fire ratings per table 6-A to an elevation of 25' above the highest roof deck, and construct offices and class rooms as per requirements for Type 1 fire rated construction. This will allow for unlimited area in all of the proposed occupancies. Fire sprinkler installation would be expected throughout the hangar, not just in the habitable areas. Consideration will need to be given to any exhibits that may obstruct the flow pattern of the sprinklers. <p><u>DMJM:</u> With the possible occupancies of A-1, A-2, A-2.1, A-3, & B-2, DMJM gave Hangar One a Type I designation since Type I has no maximum allowable area. With this designation, extensive fire-proofing has to be done. "Fireproofing may include spray-on cementitious coatings, gypsum board or plaster enclosure of the structural elements."</p> <p><u>CBC, Section 505.3</u> Allowable area of the hangar can be unlimited provided an automatic sprinkler system is installed throughout the building and the building is entirely surrounded by yards adjoining public ways not less than 60' in width. (Not all sides are surrounded by yards 60' in width.)</p>	<p>use. Sprinkler system located to protect the habitable spaces (consult with Fire Protection Specialist for design).</p> <ul style="list-style-type: none"> Design the sprinkler system to integrate with the aesthetics of the hangar. Need to identify alternative methods of achieving code-compliance for fire-resistive construction through substitution of traditional fire-proofing with non-traditional coatings (e.g. intumescent coatings) or alternate configurations of sprinkler systems (e.g. deluge-systems). The structure should not receive invasive fireproofing since this would negatively impact its historic value. 	<p>shall not mandate conformance with new construction requirements as set forth in prevailing regular code, provided the new use or occupancy does not create a fire hazard or other condition detrimental to the safety or occupants or of firefighting personnel.</p> <p>8-302.4 Regardless of use, maximum floor area for a one-story historical is 15,000 SF. Increases according to prevailing code. <i>Exceptions: Historic building provided with an approved automatic sprinkler system may be unlimited in floor area without fire-resistive area separation walls.</i></p> <p>8-409: Fire Alarm System required.</p>
<p>Occupancy Separation</p>	<p>Occupancies are "B" and "H5", with no occupancy separation.</p>	<p><u>Separation Requirements Between Occupancies:</u></p> <ul style="list-style-type: none"> A-2 or A-2.1 and B Occupancies: One-Hour Separation Required A-2.1 and E Occupancies: No Requirement for Occupancy Separation. B and E Occupancies: One-Hour Separation Required A-1 and B: Three-hour Separation <p><i>The existing structure does not have complying occupancy separations for proposed occupancy uses.</i></p>		<ul style="list-style-type: none"> Sprinkler the building to reduce the required occupancy separation. 	<p>Sec. 8-302.3: Required occupancy separations of more than one hour may be reduced to one-hour fire-resistive construction with all openings protected by not less than ¾ hour fire resistive assemblies of the self-closing or automatic closing type when the building is provided with an automatic sprinkler system throughout the entire building. Required occupancy separations of one hour may be omitted when the building is provided with an approved automatic sprinkler system throughout.</p> <p>8-402.2 Upgrading an existing qualified historic building or property to one-hour fire-resistive construction and one-hour fire resistive corridors shall not be required regardless of construction or occupancy when one of the following is provided:</p> <ol style="list-style-type: none"> An automatic fire sprinkler system throughout An approved life-safety evaluation. Other alternative measures are approved by the enforcing agency.

Issue	Existing Conditions	Proposed Modifications	Previous Recommendations	Page & Turnbull Response	State Historic Building Code
<p>Accessibility</p>	<p>The building is not ADA Compliant:</p> <ul style="list-style-type: none"> No accessible restrooms No accessible phones No drinking fountains, accessible or otherwise No accessible thermostats, light switches The second floor offices are not accessible. These are currently closed off to the public. Handrails, stairs and corridors are not ADA compliant. Floor is not level. 	<p><u>Short-term:</u></p> <ul style="list-style-type: none"> Non-accessible areas will remain closed to the public. (Use allowed in areas where clean-up and abatement has been performed.) Provide temporary, portable amenities that are handicap accessible for short-term events, as required. Level floor to eliminate tripping hazards. 	<ul style="list-style-type: none"> Provide facilities to accommodate disabled employees and visitors. 	<p><u>Long-term:</u></p> <ul style="list-style-type: none"> Provide facilities to accommodate disabled employees and visitors employing space planning that is sensitive to historic plan of the building. Cover floor-tripping hazards such as tracks and tie-downs in a manner that reveals their presence and is reversible. Provide elevator(s) as required to allow disabled users to gain access to upper floor public areas. (Additional work may be required to provide accessible routes through these areas.) 	<p>8-602.1 The regular code for access for persons with disabilities shall be applied to qualified historical buildings or properties unless strict compliance with the regular code will threaten or destroy the historical significance or character-defining features of the building or property.</p> <p>8-602.2 Alternative provisions on a case by case basis. Requires documentation, reasons why alternative provisions are provided.</p> <p>8-603.2 <u>Alternative Doors:</u></p> <ul style="list-style-type: none"> 30" and 29 1/2" single leaf doors accepted. Double doors, one leaf 29 1/2" or power assisted with both providing total of 29 1/2" opening. A power-assisted door or doors may be considered an equivalent alternative to level landings, strike side clearance and door-opening forces required by regular code. <p>8-603.4 Toilet rooms: Unisex facilities may be designated.</p> <p>8-603.5 <u>Exterior and Interior Ramps:</u></p> <ul style="list-style-type: none"> Ramp slopes no greater than 1:10, not to exceed 12 feet. Ramps of 1:6 slope not to exceed 13 inches. <p>8-604 Equivalent Facilitation: Alternatives on case by case basis. Alternatives will provide substantially equivalent or greater accessibility to, and usability of, the facility.</p>
<p>Energy</p>					<p>8-901 Historic buildings exempt from compliance with energy conservation standards. New appliances/equipment added should comply with regular code.</p>
<p>Hazardous Materials</p>	<ul style="list-style-type: none"> VCT flooring in many areas, assumed to contain asbestos. Many areas in building have loose and damaged tiles that may require abatement. Transite siding and pipe laggings are friable in some locations. 1993 Buildings inside of hangar were sampled and confirmed to contain asbestos. Sheathing of Hangar One is coated with a silver coating, which may contain asbestos. 	<p><u>Short-term:</u></p> <ul style="list-style-type: none"> Lead clean-up as funds are available. <p><u>Long-term:</u></p> <ul style="list-style-type: none"> Anticipated removal of interior asbestos containing materials when hangar is converted to new use through removal of buildings inside hangar. Anticipated maintenance, not removal, of lead-based paint to avoid problems associated with deterioration, peeling and cracking. 	<p><u>DMJM:</u></p> <p><u>Short-term:</u> The only possible abatement action that can be foreseen is removal, from ground level to about 8 feet above ground, of the silver coating on the outside of the hangar assumed to contain asbestos.</p> <p><u>Long-term:</u> If Hangar One is converted to public use, an asbestos survey of the hangar should be conducted after demolition of the existing in-hangar buildings.</p>	<ul style="list-style-type: none"> Will need survey for PCB'S. Maintenance and replacement of damaged exterior panels containing asbestos with aesthetically similar panels compliant with current standards. Maintenance and replacement decisions can be made with the advice of a specialist in this area. 	

Issue	Existing Conditions	Proposed Modifications	Previous Recommendations	Page & Turnbull Response	State Historic Building Code
	<ul style="list-style-type: none"> Possible PCB (polychlorinated biphenols) in the floor or soil associated with the electric transformers near the large motors that operate the hangar doors. Lead found on floor. South half of the hangar has been cleaned. Peeling paint assumed to contain lead, throughout. Fire Suppression system is CO2 system in certain areas of the Hangar. Areas where this system exists, have been closed off. 				
Light and Ventilation			<u>DMJM:</u> <ul style="list-style-type: none"> Maintain existing light and ventilation. Supplement existing light and ventilation. Additional electrical and mechanical to provide required minimum level of light and air circulation. 	<ul style="list-style-type: none"> Supplemental ventilation will defer to the historic character of the building. Any new penetrations to the skin of the building shall not be done without prior consent of the building officials and SHPO. Supplemental lighting will integrate with the industrial vocabulary of the building. New equipment appliances shall be vented properly so as not to create fire hazards. 	8-302 Existing provisions for light and ventilation which do not, in the opinion of the enforcing agency, constitute a safety hazard may remain.
Weather Protection	<ul style="list-style-type: none"> Existing roof leaks. Possible black mold at leaks. East entrance: Roll-up door permanently held open via new columns. 	<u>Short-Term:</u> Make necessary repairs as funds become available. <u>Long-Term:</u> Repairs made as per DMJM's recommendation.	<u>Kaiser & Folsom:</u> <ul style="list-style-type: none"> Repair leaks. Abate areas containing black mold. <u>DMJM:</u> <ul style="list-style-type: none"> Scope of work related will be met through rehabilitation of the existing building skin and window openings. 	<u>Short-Term:</u> <ul style="list-style-type: none"> Repair leaks. Repair details approved by building officials and SHPO. <u>Long-Term Use:</u> <ul style="list-style-type: none"> Remove columns. Restore entrance. 	8-408 The original or historic roofing system detailed/modified as necessary to provide shelter to the building occupants and exclude dampness, while preserving the historic materials and appearance of the roof.
Civil	<ul style="list-style-type: none"> No formal civil survey of the existing conditions has been conducted. Existing storm drain may not have adequate capacity for severe 25 year storm. 	<u>Short-Term Use:</u> <ul style="list-style-type: none"> May need to upgrade the storm drain, based on a formal civil survey. <u>Long-Term Use:</u> <ul style="list-style-type: none"> All proposed re-use conditions will take place within Hangar. Therefore, the existing storm drain will not be impacted. Additional sewer lines may be required to meet re-use conditions. Water mains may need to increase in size to support new occupancy. Clean and repair existing utilities. Verify proper operations. 	<u>DMJM:</u> <i>DMJM's response was based on original design drawings. No formal survey was conducted to verify existing conditions.</i> <ul style="list-style-type: none"> There does not appear to be any civil conditions that would prevent the re-use of Hangar One as a public building. Calculate occupancy and fixture units required. Compare with capacity of existing sewer lines. Increase water main to meet new demand. 	<ul style="list-style-type: none"> Civil Survey to confirm existing conditions and identify deficiencies. Civil upgrades to be approved by Building Official and SHPO. Any new construction adjacent to the building must be carefully reviewed by the Fire Marshall. Only construction that is deemed necessary and for the purpose of serving the building should be allowed. Any new construction shall be planned so as not to diminish any space dedicated to fire truck use. 	8-1001 Alternative regulations and criteria shall apply to all sites, open space, access ways, artifacts and landscape areas associated with qualified historical buildings or historic districts. 8-1002 The relationship between a structure and its site is important and of special importance in historic districts.





The following content was redacted from this public posting:

Appendix D: Utility Condition Drawings

Appendix E

Hangar One Historic Items Release and Transfer Form

Appendix E: Hangar 1 Historic Items Release and Transfer Form

HANGAR 1 HISTORIC ITEMS RELEASE AND TRANSFER FORM												
CONTRACT NO. N62473-08-D-8816 0005						DATE: Wednesday / 28-Jul-2010						
						TITLE AND LOCATION: HANGAR 1 REMEDIATION MOFFETT FIELD, CA 94035						
PHOTO (when available)	Item/Material Sampled	Painted?	Lead Wipe Sample		PCB Wipe Sample		OK for Unrestricted Delivery To NASA	OK for Restricted Delivery to NASA (note)	Requires re-cleaning & re-testing	Date AMEC Transferred (to NASA)	Name/Division of NASA Personnel Receiving Item(s)	Signature of NASA Personnel Receiving Item(s)
			Lab Results (ug/99. ft)	Unrestricted Clearance Criteria (ug/99. ft.)	Lab Results (ug/100 cm ²)	Unrestricted Clearance Criteria (ug/100 cm ²)						
	Large steel wrench (BFW)	Yes (yellow faded)	750.0	250.0	0.50	10.0	-	Yes (1)	-	9-28-10	K JAMES	Kelly James
	Hydro line bottle (Steel containers with black rubber hoses) (Serial # AX-23681)	Yes (faded neon green)	< 70.0	250.0	< 0.10	10.0	Yes	-	-	18 Aug 2010	Randy Hobbs Code JO	R Hobbs
	Hydro line bottle (Steel containers with black rubber hoses) (Serial # AX-18154)	Yes (faded neon green)	< 70.0	250.0	< 0.10	10.0	Yes	-	-			
	Hydro line bottle (Steel containers with black rubber hoses) (Serial # AX-14501)	Yes (faded neon green)	< 70.0	250.0	0.17	10.0	Yes	-	-			
	Hydro line bottle (Steel containers with black rubber hoses) (Serial # AX-24424)	Yes (faded neon green)	< 70.0	250.0	< 0.10	10.0	Yes	-	-			
	Flight equipment (mainly metal computer boxes)	One side is painted light yellow	< 70.0	250.0	< 0.10	10.0	Yes	-	-	18 Aug 2010	KELLY JAMES CODE JSL	Kelly James
	Flight equipment (mainly metal computer boxes)	One side is painted light yellow	< 70.0	250.0	< 0.08	10.0	Yes	-	-			
	Flight equipment (mainly metal computer boxes)	One side is painted light yellow	< 70.0	250.0	0.10	10.0	Yes	-	-			
	Blue metal "Monkey" boxes (Serial # 000 & 010)	Yes (blue)	< 70.0	250.0	< 0.10	10.0	Yes	-	-			
	Blue metal "Monkey" boxes (Serial # 030 & 003)	Yes (blue)	< 70.0	250.0	< 0.10	10.0	Yes	-	-			
	Blue metal "Monkey" boxes (Serial # 004 & 001)	Yes (blue)	< 70.0	250.0	< 0.10	10.0	Yes	-	-			
	Blue metal "Monkey" boxes (Serial # 002 & 005)	Yes (blue)	< 70.0	250.0	0.10	10.0	Yes	-	-			
	Blue metal "Monkey" boxes (Serial # 007 & 008)	Yes (blue)	< 70.0	250.0	< 0.10	10.0	Yes	-	-			
	Yellow wood blocks for securing aircraft	Yes (yellow)	3500.0	250.0	0.75	10.0	-	Yes (1)	-	17/18 Aug 2010	H. Parsons AFHS	H. Parsons
	Strip gaskets skeleton - horizontal skeleton	No	120.0	250.0	2.0	10.0	-	-	Yes	02/15/10	H. Parsons AFHS	H. Parsons
	Strip gaskets skeleton - horizontal skeleton	No	2200.0	250.0	1.2	10.0	-	-	Yes			
	Strip gaskets skeleton - vertical skeleton	No	420.0	250.0	0.35	10.0	-	-	Yes			
	Strip gaskets skeleton - vertical skeleton	No	560.0	250.0	< 0.10	10.0	-	-	Yes			
	USCG bell (cast iron)	Possibly painted light	< 75.0	250.0	< 0.10	10.0	Yes	-	-	18 Aug 2010	Kelly James Code JSL	Kelly James
	USCG bell base (steel)	Yes (blue)	< 75.0	250.0	< 0.10	10.0	Yes	-	-			

Note - Lead Base paint remains - torch cutting or heating can produce toxic fumes.

Notes:
 1 - Potentially Lead Paint on item, NASA accepts the item as is with known lead contamination present
 2 - NASA accepts the item with potential contamination on painting. Sampling of painting was not possible to protect painting.

HANGAR 1 HISTORIC ITEMS RELEASE AND TRANSFER FORM

CONTRACT NO: **N62473-08-D-8816 0005**

DATE: **Wednesday / 28-Jul-2010**

TITLE AND LOCATION: **HANGAR 1 REMEDIATION
MOFFETT FIELD, CA 94035**

PHOTO (when available)	Item/Material Sampled	Painted?	Lead Wipe Sample		PCB Wipe Sample		OK for unrestricted Delivery To NASA	OK for Restricted Delivery to NASA (note)	Requires re-cleaning & re-testing	Date AMEC Transferred Item to NASA	Name/Division of NASA Personnel Receiving Item(s)	Signature of NASA Personnel Receiving Item(s)	
			Lab Results (ug/100 sq. ft.)	Unrestricted Clearance Criteria (ug/100 sq. ft.)	Lab Results (ug/100 sq. ft.)	Unrestricted Clearance Criteria (ug/100 sq. ft.)							
<input checked="" type="checkbox"/>	Rubber mat with writing (Mat #1 - Black edge with white middle)	No	< 75.0	250.0	< 0.10	10.0	Yes			17 Aug / 2010	MFHS H. PARSONS	H.P. Parsons	
<input checked="" type="checkbox"/>	Rubber mat with writing (Mat #2 - Yellow edge with blue middle)	No	120.0	250.0	0.12	10.0	Yes						
<input checked="" type="checkbox"/>	Rubber mat with writing (Mat #3 - Black edge with black middle)	No	90.0	250.0	< 0.10	10.0	Yes						
<input checked="" type="checkbox"/>	Eagles & Anchor Club sign (plastic USN sign)	Yes	< 75.0	250.0	< 0.10	10.0	Yes			17 Aug / 2010	MFHS H. PARSONS	H.P. Parsons	
<input checked="" type="checkbox"/>	Eagles & Anchor Club sign (gold painted metal)	Yes (gold)	< 75.0	250.0	< 0.10	10.0	Yes						
<input checked="" type="checkbox"/>	Display case (wood side)	No	< 75.0	250.0		10.0	Yes			17 Aug / 2010	MFHS H. PARSONS	H.P. Parsons	
<input checked="" type="checkbox"/>	Display case (wood side)	No	< 75.0	250.0		10.0	Yes						
<input checked="" type="checkbox"/>	Display case (wood front)	No	< 75.0	250.0		10.0	Yes						
<input checked="" type="checkbox"/>	Display case (glass on front)	No	< 75.0	250.0		10.0	Yes						
<input checked="" type="checkbox"/>	Display case (glass on top)	No	< 75.0	250.0		10.0	Yes						
<input checked="" type="checkbox"/>	Display case (wood side)	No	< 75.0	250.0		10.0	Yes						
<input checked="" type="checkbox"/>	Display case (wood side)	No	< 75.0	250.0		10.0	Yes						
<input checked="" type="checkbox"/>	Display case (wood plywood inside case)	No	< 75.0	250.0	< 0.10	10.0	Yes						
<input checked="" type="checkbox"/>	Display case (metal plywood inside case)	No	< 75.0	250.0	< 0.10	10.0	Yes		17 Aug	MFHS H. PARSONS MFHS H. PARSONS	H.P. Parsons		
<input checked="" type="checkbox"/>	Public Works Officer Plaque (wood frame)	Yes (brown, black)	< 75.0	250.0	< 0.10	10.0	Yes			17 Aug	MFHS H. PARSONS	H.P. Parsons	
<input checked="" type="checkbox"/>	Public Works Officer Plaque (wood base)	No	120.0	250.0	0.22	10.0	Yes						
<input checked="" type="checkbox"/>	Public Works Officer Plaque (wood lettering on front)	Yes (light yellow)	< 75.0	250.0	< 0.10	10.0	Yes						
<input checked="" type="checkbox"/>	Plexiglass case	No	< 75.0	250.0	< 0.10	10.0	Yes			17 Aug	MFHS H. PARSONS	H.P. Parsons	
<input checked="" type="checkbox"/>	Plexiglass case	No	< 75.0	250.0	0.34	10.0	Yes						
<input checked="" type="checkbox"/>	Commanding Officer Naval sign (metal)	Yes (blue)	< 75.0	250.0	< 0.10	10.0	Yes			17 Aug	MFHS H. PARSONS	H.P. Parsons	
<input checked="" type="checkbox"/>	Commanding Officer Naval sign (metal)	Yes (blue)	< 75.0	250.0	< 0.10	10.0	Yes			17 Aug	MFHS H. PARSONS	H.P. Parsons	
<input checked="" type="checkbox"/>	Waste disposal galvanized container	No	980.0	250.0	0.12	10.0	No			17 Aug	MFHS H. PARSONS	H.P. Parsons	
<input checked="" type="checkbox"/>	Work ladder (metal)	Yes (light blue)	120.0	250.0	< 0.10	10.0	Yes			2 Sept 10	MFHS H. PARSONS	H.P. Parsons	
<input checked="" type="checkbox"/>	Work ladder (metal)	Yes (light blue)	< 75.0	250.0	0.12	10.0	Yes						
<input checked="" type="checkbox"/>	Work ladder (metal)	Yes (dark blue)	240.0	250.0	0.25	10.0	Yes						
<input checked="" type="checkbox"/>	Work ladder (metal)	Yes (dark blue)	< 75.0	250.0	< 0.10	10.0	Yes						
	Cross Landing welcome Abroad 5/10										17 Aug 2010	MFHS H. PARSONS	H.P. Parsons

Notes:

- 1 - Potential Lead Paint on item. NASA accepts this item as is with known lead contamination present.
- 2 - NASA accepts this item with potential contamination on painting. Sampling of painting was not possible to protect painting.

HANGAR 1 HISTORIC ITEMS RELEASE AND TRANSFER FORM

DATE: **Wednesday / 28-Jul-2010**

CONTRACT NO: **N62473-08-D-8816 0005**

TITLE AND LOCATION: **HANGAR 1 REMEDIATION
MOFFETT FIELD, CA 94035**

PHOTO (when available)	Item/Material Sampled	Painted?	Lead Wipe Sample		PCB Wipe Sample		OK for unrestricted Delivery To NASA	OK for Restricted Delivery to NASA (note)	Requires re-cleaning & re-testing	Date AMEC Transferred Item to NASA	Name/Division of NASA Personnel Receiving Item(s)	Signature of NASA Personnel Receiving Item(s)
			Lab Results (µg/100 ft²)	Unrestricted Clearance Criteria (µg/100 ft²)	Lab Results (µg/100 cm²)	Unrestricted Clearance Criteria (µg/100 cm²)						
	Drawing file cabinet #1 (wood top)	Yes (white)	< 75.0	250.0	<0.10	10.0	Yes	-	-	8/18/10	KELLY JAMES CODE JSL	Kelly James
	Drawing file cabinet #1 (metal side)	No	< 75.0	250.0	<0.10	10.0	Yes	-	-			
	Drawing file cabinet #1 (metal drawer)	No	< 75.0	250.0	<0.10	10.0	Yes	-	-			
	Drawing file cabinet #1 (poster inside metal drawer)	No	< 75.0	250.0	<0.10	10.0	Yes	-	-			
	Drawing file cabinet #1 (metal drawer)	No	< 75.0	250.0	<0.10	10.0	Yes	-	-			
	Drawing file cabinet #1 (poster inside metal drawer)	No	< 75.0	250.0	<0.10	10.0	Yes	-	-			
	Drawing file cabinet #2 (metal top)	No	< 75.0	250.0	<0.10	10.0	Yes	-	-	8/18/10	KELLY JAMES CODE JSL	Kelly James
	Drawing file cabinet #2 (metal side)	No	< 75.0	250.0	0.13	10.0	Yes	-	-			
	Drawing file cabinet #2 (metal drawer)	No	< 75.0	250.0	<0.10	10.0	Yes	-	-			
	Drawing file cabinet #2 (poster inside metal drawer)	No	< 75.0	250.0	<0.10	10.0	Yes	-	-			
	Drawing file cabinet #2 (metal drawer)	No	< 75.0	250.0	<0.10	10.0	Yes	-	-			
	Drawing file cabinet #2 (poster inside metal drawer)	No	< 75.0	250.0	0.15	10.0	Yes	-	-			
	Drawing file cabinet #3 (metal top)	No	< 75.0	250.0	<0.10	10.0	Yes	-	-	8/18/10	KELLY JAMES CODE JSL	Kelly James
	Drawing file cabinet #3 (metal side)	No	< 75.0	250.0	<0.10	10.0	Yes	-	-			
	Drawing file cabinet #3 (metal drawer)	No	< 72.0	250.0	<0.10	10.0	Yes	-	-			
	Drawing file cabinet #3 (poster inside metal drawer)	No	< 72.0	250.0	<0.10	10.0	Yes	-	-			
	Drawing file cabinet #3 (metal drawer)	No	< 72.0	250.0	<0.10	10.0	Yes	-	-			
	Drawing file cabinet #3 (poster inside metal drawer)	No	< 72.0	250.0	<0.10	10.0	Yes	-	-			
	Optical bench with pneumatic isolators (metal top)	No	< 72.0	250.0	0.11	10.0	Yes	-	-	8/18/10	KELLY JAMES CODE JSL	Kelly James
	Optical bench with pneumatic isolators (metal side)	Yes (blue)	< 72.0	250.0	0.10	10.0	Yes	-	-			
	Optical bench with pneumatic isolators (steel canister - isolator)	No	< 72.0	250.0	0.15	10.0	Yes	-	-			

Notes:

- 1 - Potential Lead Paint on item, NASA accepts this item as is with known lead contamination present
- 2 - NASA accepts this item with potential contamination on painting. Sampling of painting was not possible to protect painting.

HANGAR 1 HISTORIC ITEMS RELEASE AND TRANSFER FORM

DATE: Wednesday / 28-Jul-2010

CONTRACT NO: N62473-08-D-8816 0005

TITLE AND LOCATION: HANGAR 1 REMEDIATION
MOFFETT FIELD, CA 94035

PHOTO (when available)	Item/Material Sampled	Painted?	Lead Wipe Sample		PCB Wipe Sample		OK for unrestricted Delivery To NASA	OK for Restricted Delivery to NASA (note)	Requires re-cleaning & re-testing	Date AMEC Transferred Item to NASA	Name/Division of NASA Personnel Receiving Item(s)	Signature of NASA Personnel Receiving Item(s)
			Lab Results (mg/kg, #)	Unrestricted Clearance Criteria (ug/kg, ft.)	Lab Results (ug/kg, #)	Unrestricted Clearance Criteria (ug/100 cm2)						
	Large painting of Moffett Field (sample taken on painting)	Yes	< 72.0	250.0	< 0.10	100	-	Yes - (2)	-	07-5-28-2010	H. Parsons MFFHS	
	Large painting of Moffett Field (wood frame)	Stained	< 72.0	250.0	< 0.10	100	-	Yes - (2)	-			
	Large painting of Moffett Field (back of wood painting)	No	< 72.0	250.0	0.15	100	-	Yes - (2)	-			
	Black extension cable (rubbery)	No	< 72.0	250.0	1.6	> 100	Yes	-	-	24 Aug 10	H. Parsons MFFHS	
	Jig for building blimp model (wood)	Yes (white)	< 72.0	250.0	< 0.10	100	Yes	-	-	24 Aug 10	H. Parsons MFFHS	
	Jig for building blimp model (wood)	No	< 72.0	250.0	< 0.10	100	Yes	-	-			
	Plastic display case with contents (poster inside case)	No	< 72.0	250.0	< 0.10	100	Yes	-	-	17 Aug 10	H. Parsons MFFHS	
	Plastic display case with contents (glass on display case)	No	< 72.0	250.0	< 0.10	100	Yes	-	-			
	Plastic display case with contents (wood side)	Yes (white)	< 72.0	250.0	0.15	> 100	Yes	-	-			
	Lift pallet (steel)	No	490.0	250.0	0.31	> 100	-	-	Yes	2 Sept 10	H. Parsons MFFHS	
	Power tackaw (metal)	Yes (black)	< 72.0	250.0	1.0	> 100	Yes	-	-	17 Aug 10	MFFHS H. Parsons	
	Heavy hand truck (iron)	No (dark rusty)	1100.0	250.0	0.30	> 100	-	-	Yes	2 Sept 10	MFFHS H. Parsons	
	Flat bed moving cart/body (steel)	No	200.0	250.0	0.38	100	Yes	-	-	17 Aug 10	MFFHS H. Parsons	
	"Hal & Farewell" posters/brochures - Box #1	X	< 72.0	250.0	< 0.10	> 100	Yes	-	-	24 Aug 10	MFFHS H. Parsons	
	"Hal & Farewell" posters/brochures - Box #1	X	< 72.0	250.0	< 0.10	100	Yes	-	-			
	"Hal & Farewell" posters/brochures - Box #2	X	< 72.0	250.0	< 0.10	> 100	Yes	-	-			
	"Hal & Farewell" posters/brochures - Box #2	X	< 72.0	250.0	< 0.10	100	Yes	-	-			
	"Hal & Farewell" posters/brochures - Box #3	X	< 72.0	250.0	< 0.10	100	Yes	-	-			
	"Hal & Farewell" posters/brochures - Box #3	X	< 72.0	250.0	< 0.10	100	Yes	-	-			
	"The Last Air Show" posters - Box #4	X	< 72.0	250.0	< 0.10	100	Yes	-	-			
	"The Last Air Show" posters - Box #4	X	< 72.0	250.0	< 0.10	100	Yes	-	-			

Notes:

- 1 - Potential Lead Paint on item. NASA accepts this item as is with known lead contamination present.
- 2 - NASA accepts this item with potential contamination on painting. Sampling of painting was not possible to protect painting.

Hangar 1 Proposed Renovations Preliminary Fire Risk Assessment



Jan. 12, 2009

Keith Venter, Tim Gafney, Tony Caringello, Herb Jewell,
Rich Morrison, Koushik Datta

NASA Ames Research Center

Executive Summary

Ames Research Center is seeking to make maximum practicable use of Hangar 1 subsequent to its proposed restoration. Potential uses of the hangar include storage and light, non-hazardous maintenance of air vehicles (e.g. fixed-wing aircraft, helicopters, and/or rigid/non-rigid airships), and special short-term events such as public engagements. The Center Facilities Engineering Division, Protective Services Office, and the Safety, Environmental, and Mission Assurance Directorate performed a preliminary qualitative fire risk assessment study. The study focused on the fire risk trade-off of installing or not installing a Special Hazard Fire Suppression System (e.g. NFPA 16-compliant foam-water sprinkler or spray system) in the Hangar 1 deck areas. Due to time limitations, this study does not assess all potential uses, but is limited to storage and light maintenance of aircraft and airships and limited duration special events in Hangar 1.

Since the proposed renovated configuration and uses of Hangar 1 are unknown at this point, the fire risk assessment was performed with the following major assumptions:

- Hangar 1 is planned to be extensively modified prior to operations. All interior sub-standard structures and the exterior sidings are assumed to be removed. The new similar looking exterior siding planned replacement, is assumed to be fire resistant.
- Other than the Special Hazard Fire Suppression System, Hangar 1 is planned to be modified in accordance with current fire codes. The proposed renovated Hangar 1 is assumed to have a fire alarm system with communication interfaces with the NASA/Ames Emergency Dispatch Center. The number and positioning of both hangar and occupant ingress/egress doors is assumed to be compliant to fire codes for proper means of egress. All Hangar 1 auxiliary shops and offices created are assumed to be in accordance with current fire codes, including having sprinkler systems.
- This is a limited qualitative Fire Risk Assessment. The analysis does not cover other risks such as seismic, storm damage, or emergency evacuation risks.
- Operations within Hangar 1 are assumed to be limited to light maintenance and storage of aircraft and airships, and short term special events.
- Hangar 1 proposed renovations are assumed to provide adequate firefighting resources, such as firefighting apparatus and the staffing thereof, water supply, water pressure, hydrants, standpipes, etc. in accordance with current fire codes.
- Hangar 1 proposed renovations are assumed to provide adequate accessibility for firefighting.
- Hangar 1 lifetime is assumed to be approximately thirty years for the purpose of this analysis.

The results of the risk assessment are shown in Figure 1. The risk matrix remains the same, whether Hangar 1 does or does not have a Special Hazard Fire Suppression System. Additional assessed risks lower in either consequence and/or likelihood are not shown in Figure 1.

Likelihood	Likely					
	Probable	With or Without Special Hazard Fire Suppression System				
	May Occur		With or Without Special Hazard Fire Suppression System	With or Without Special Hazard Fire Suppression System		
	Unlikely				With or Without Special Hazard Fire Suppression System	
	Improbable					With or Without Special Hazard Fire Suppression System
		Negligible	Minor	Major	Critical	Catastrophic
		Consequence				

Figure 1: Fire Risk Assessment Matrix for Hangar 1

Examination of the risk matrix shows that there is very little qualitative difference between the two options in terms of their highest severity risk — they both are yellow reflecting a medium level of risk. Therefore, installation of a Special Hazard Fire Suppression System does not appear to qualitatively reduce the assessment of risk from a major fire in the hangar. In most ARC applications, this risk can be accepted by a project/facility with suitable examination of the accident sequences and their risk management plan.

Details of the assessment and the assumptions are provided in the rest of the report.

Methodology

The methodology is that of a probabilistic risk analysis, consisting of event trees. Fault trees for all initiating events were generated but are not included in the report. They were used to generate the probabilities of the initiating events in the various event trees included in the report.

Potential accident sequences for Fire in Hangar 1 were developed in the SAPHIRE software code by developing event trees. Each path in an event tree represents one accident sequence. The event tree displays an initiating event, which disrupts normal operations, followed by a sequence

of events (in time) involving success and/or failure of system components. Each path in the event tree is an accident scenario sequence logic of systems that either succeed or fail during the accident sequence.

Each accident sequence was assessed in terms of its consequence and likelihood. The consequence is an assessment of the worst credible potential result. The likelihood is the probability that the identified accident sequence will occur. Consequences were classified as Catastrophic, Critical, Major, Minor, and Negligible. Likelihoods were classified as Likely to occur, Probably will occur, May Occur, Unlikely to occur, and Improbable to occur, in the life of the facility, which for the purposes of this analysis is assumed to be approximately thirty years.

Given the consequence and likelihood, the risk assessment code is obtained from a 5x5 risk matrix shown in Figure 2. The risk is qualitatively rated as high, medium, or low (shown as red, yellow, or green in the matrix).

Likelihood	Likely					
	Probable					
	May Occur					
	Unlikely					
	Improbable					
		Negligible	Minor	Major	Critical	Catastrophic
		Consequence				

Figure 2: Fire Risk Matrix used in this assessment

The methodology was limited in terms of the initiating events assessed. Only fire risk was assessed for the hangar area, due to fire initiating events from either in the hangar area or in an aircraft, airship or special event. Initiating fire events in office spaces are covered by the fire codes and not addressed in this assessment.

All other initiating events, like seismic or storm events, were not assessed.

In summary, this was a limited-scope preliminary fire risk assessment for Hangar 1. The trade space was an analysis of the risk of major fire with, and risk of major fire without, a Special Hazard Fire Suppression System for Hangar 1.

Hangar 1 Proposed Renovations Assumptions

- It is assumed that the current Hangar 1 will be completely gutted with only the steel frame remaining as per the Navy's Engineering Evaluation / Cost Analysis, Revision 1 preferred Alternative #10, dated 7/30/2008.
 - All exterior siding and internal structures are assumed to have been removed.
 - All wood framed buildings within the hangar are assumed to have been removed.
 - The original roof's wooden planking is assumed to have been removed or to have had a fire retardant treatment applied.
- Hangar 1 is assumed to have been proposed renovated and modified prior to operations as follows:
 - All hangar new interior walls are assumed to be of fire resistant material.
 - The new siding planned for Hangar 1 is assumed to be fire resistant.
 - Hangar upgrades and proposed renovations are assumed to include adequate fire detection, alarms and water supply systems.
 - Hangar is assumed to have a fire alarm system that is compliant with current safety code requirements, including direct communication with the NASA/Ames Emergency Dispatch Center.
 - Hangar upgrades and proposed renovations are assumed to include operational hangar and occupant ingress/egress doors. The number and positioning of both hangar and occupant ingress/egress doors are assumed to be in accordance with current fire codes.
 - All catwalks and elevators are assumed to have been made sound and functional as part of hangar upgrades and proposed renovations.
 - Hangar ventilation is assumed to preclude the buildup of vapors from minor fuel leaks from any aircraft stored in the hangar.
 - All electrical boxes, raceways, or substations in Hangar 1 are assumed to be code compliant for the particular fuel vapor zone. The wiring for the hangar cranes is assumed to be code compliant.
 - Any Hangar 1 auxiliary shops and offices after proposed renovations are assumed to be code compliant and include sprinkler systems.
 - Hangar roofing is assumed to be equipped with water standpipes, unless deemed unnecessary (such as when inflammable materials are used).
 - The hangar roof is assumed to be accessible to firefighters as part of the upgrades.
 - The building is assumed to be secured from unauthorized entry.

- The proposed renovated Hangar 1 is assumed to have emergency exit plans where:
 - A Building Emergency Action Plan (BEAP) is created for both the permanent aviation use of Hangar 1 and the temporary public assembly (e.g. special events) use of Hangar 1.
 - Emergency lighting systems and appropriate emergency exit signs are installed.
 - Emergency Egress capability sufficient for the number of people occupying Hangar 1.
 - Emergency exits remain free of obstructions.
 - Arrangements have been made to evacuate anyone with physical or mental impairments.
 - Plans are regularly reviewed to cover any building alterations.
- Hangar 1 is assumed to have a designated 'responsible person' to ensure fire guidelines are met, to ensure fire hazard assessments are carried out, and to identify/rectify any potential hazards. In case of multiple occupants in Hangar 1, multiple 'responsible people' may be designated, either from within the respective organizations or from NASA.

Reducing the Likelihood of a Fire Initiating Event in Hangar 1

To reduce any fire risk to Hangar 1, operations within the hangar will be limited to storage and light maintenance of the aircraft/airships plus limited duration special events. The following assumptions reduce the likelihood of a fire initiating event:

- No welding, no hot work, no open flame operations in hangar.
- Aircraft/airship engines and Auxiliary Power Units need to be powered off before entering the hangar.
- Aircraft/airships should not be refueled inside the hangar.
- Fuels stored within aircraft/airships in the hangar should be limited JP4, JP5, and avgas
- Aircraft/airship need to be continuously monitored anytime aircraft/airships are powered up in the hangar. Continuous-monitoring of powered-up aircraft/airships within Hangar 1 may need to include a hard standby involving NASA/Ames Fire Department resources.
- Any cryogenic storage systems used in Hangar 1 should have suitable containment features to eliminate the potential for liquid oxygen pooling in the presence of hydrocarbons.
- Airship skins need to be non-flammable.
- Airship lifting gases need to be limited to helium not hydrogen.
- Aircraft need to be removed from hangar or defueled before limited duration special events.
- Special events need to be monitored continuously by fire protection personnel.

- Special event configurations should be reviewed and approved by the NASA/Ames Construction Permit Review Board (CPRB) which includes a NASA/Ames Fire & Emergency Services Branch representative.

In essence, the amount and arrangement of flammable materials are controlled to prevent the spread of fire in the hangar; any potential fire is isolated in well-defined areas, by firebreaks or other techniques, without propagation paths to other areas. Other assumptions ensure that ignition sources are eliminated or controlled.

Hangar 1 Without Any Special Hazard Fire Suppression Systems

This section assumes that the proposed renovated Hangar 1 will not have a Special Hazard Fire Suppression System. The Special Hazard Fire Suppression System may include hangar floor sprinklers or under wing deluge system. Discussions with ARC personnel suggest that such a system will not be effective due to size and volume of Hangar 1. This is the first option in the trade study.

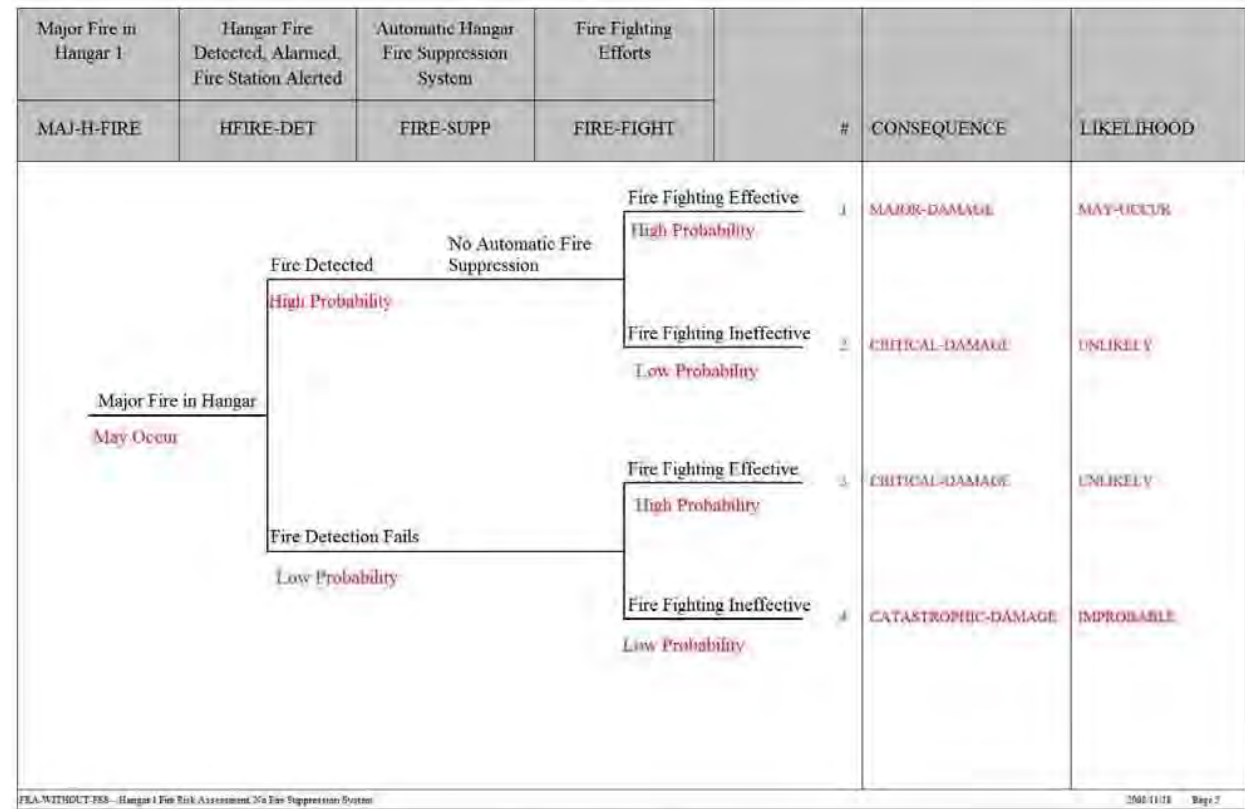

Figure 3: Event Tree for Fire Risk in Hangar 1 *without* any Special Hazard Fire Suppression System

The event tree in Figure 3 represents event sequences that could lead to fire damage in Hangar 1 and whose worst-case likelihood of occurrence has been judged to be as: “May Occur” in the life of the hangar.

Fault trees were developed for the initiating event where three basic events must occur to trigger the initiating event, a major fire in the hangar: the presence of flammable material, an ignition source, and local fire fighting to be ineffective. Each of these basic events is either “Likely” or “Probable” to occur, but the combination of the three is assessed to have a likelihood of “May Occur.” In addition, as shown in later sections, event trees developed for aircraft and airship fires as well as for fires during limited duration special events, that show the likelihood of a major fire in Hangar 1 could occur with a likelihood of “May Occur” (in the life of the hangar) or lower.

The first event branch that then occurs is fire detection. It was judged that there is a high probability that a major fire in the hangar would be successfully detected by the new fire detection/alarm system, conversely it was judged that there is a low probability that fire detection would fail.

No branching occurs at the second branch since there is no Special Hazard Fire Suppression System.

At the third branch: if the fire is detected the alarm is set-off and the NASA/Ames Emergency Dispatch Center is notified. Since the NASA/Ames fire station is very close to Hangar 1, the response - *if* NASA/Ames Fire Department resources are in quarters and not assigned to another emergency incident - should be immediate and the team assessed that fire fighting should be effective (event sequence #1, Figure 3) with a high probability occurrence; and only with a low probability that fire fighting be ineffective (event sequence #2, Figure 3).

A major fire occurrence with effective firefighting (event sequence #1, Figure 3) was assessed to result in “Major damage” as a consequence with likelihood that it “May Occur” in the life of the hangar. A major fire with ineffective firefighting (event sequence #2, Figure 3) was assessed to result in “Critical Damage” as a consequence with a likelihood of “Unlikely” to occur in the life of the hangar. If the fire is not detected automatically, it eventually will get detected by personnel and the fire station notified. However, the notification is relatively late in this case (as compared to when the fire is automatically detected and the fire station is automatically notified). So in this case late effective firefighting results in “Critical Damage” (event sequence #3, Figure 3). Otherwise ineffective firefighting (event sequence #4, Figure 3) would result in “Catastrophic Damage” to hangar, which was judged to have an “Improbable” likelihood of occurrence in the life of the hangar.

The resulting consequence / likelihood of these accident sequence scenarios are shown in the risk matrix of Figure 4.

Likelihood	Likely					
	Probable					
	May Occur			X		
	Unlikely				X	
	Improbable					X
		Negligible	Minor	Major	Critical	Catastrophic
		Consequence				

Figure 4: Risk Assessment Matrix for Fire in Hangar 1 without any Special Hazard Fire Suppression System

Hangar 1 *With* Special Hazard Fire Suppression Systems

This section of the trade study assumes that Hangar 1 has a Special Hazard Fire Suppression System. This is the second option of this trade study.

Discussions with ARC personnel suggest that a Special Hazard Fire Suppression System will not be effective in Hangar 1, due to the hangar’s very large volume and significant height and width. The effectiveness of a Special Hazard Fire Suppression System could not be quantified; however, it was judged that it would be conservative to assume that it could have at most a fifty-fifty effectiveness.

The initiating event (a major fire in hangar) in this *-with* Special Hazard Fire Suppression System event tree (Figure 5) represents the same initiating event used in the previous *-without* Special Hazard Fire Suppression System event tree (Figure 3). For the initial sequence fault trees were developed for this initiating event where three basic events must occur to trigger the initiating event: the presence of flammable material, an ignition source, and local fire fighting to be ineffective) for a major fire in the hangar. Each of these basic events is either “Likely” or “Probable” to occur, but the combination of the three is assessed to have a likelihood of “May Occur”.

The first event branch that then occurs is fire detection. As in the previous event tree sequence, there is a high probability that a major fire will be detected by the detection/alarm system, and a low probability that the system will fail to detect a major fire.

The next event branch is different in the two event trees because of inclusion of the Special Hazard Fire Suppression System. In this event branch if the fire suppression system is effective (event sequence #1, Figure 5), it results in “Minor Damage” to the hangar with a “May Occur” likelihood of occurrence in the life of the hangar.

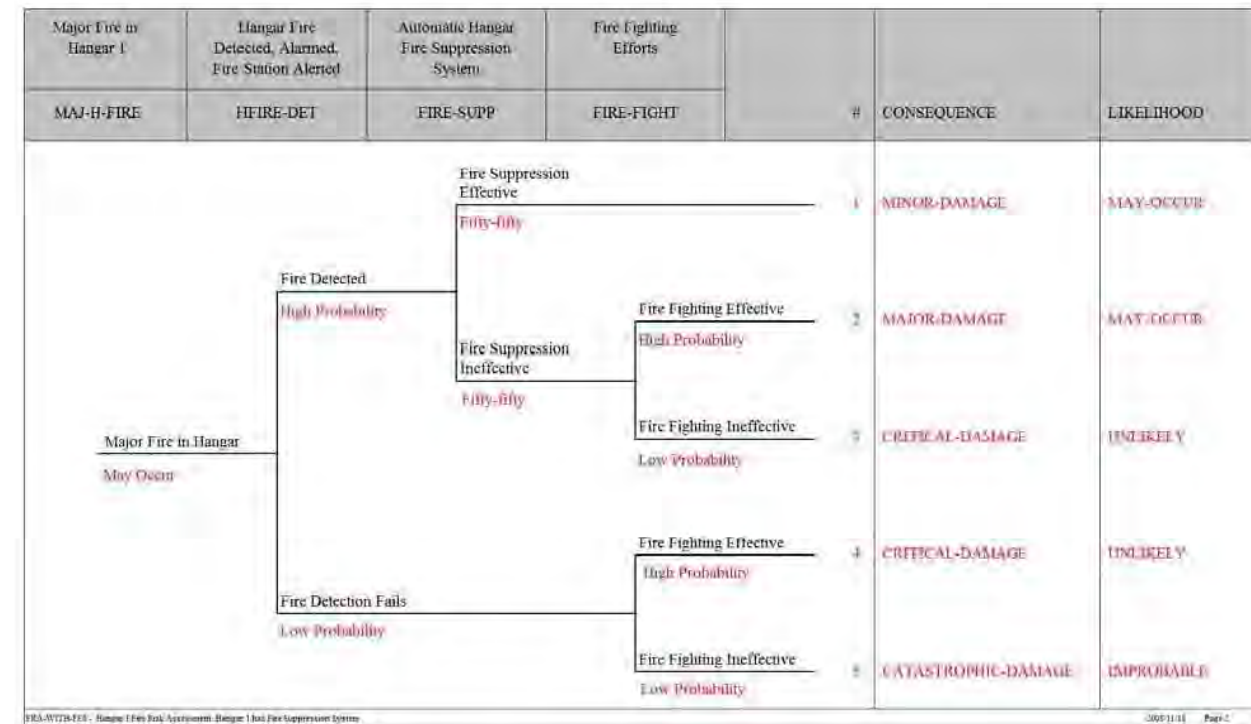

Figure 5: Event Tree for Fire Risk in Hangar 1 with a Special Hazard Fire Suppression System

If the fire suppression system is not effective, firefighting efforts (event sequence #2, Figure 5) were judged to have a high probability of limiting the fire damage, since the NASA/Ames fire station is adjacent to Hangar 1 and can react immediately *if* NASA/Ames Fire Department resources are in quarters and not assigned to another emergency incident. Event sequences 2 and 3 are assessed to have “Major damage” and “Critical damage,” respectively — just like the previous event tree in Figure 3. These event sequences also occur with the same likelihood, the reason being that the probabilities are reduced by a factor of two but not by an order of magnitude. When fire is not detected automatically, the accident sequences are identical to earlier event tree for hangar fire risk *without* the Special Hazard Fire Suppression System in Figure 3.

The resulting consequence likelihood of these accident sequence scenarios are shown in the risk matrix of Figure 6.

Likelihood	Likely	Yellow	Yellow	Red	Red	Red
	Probable	Green	Yellow	Yellow	Red	Red
	May Occur	Green	Green	Yellow	Yellow	Red
	Unlikely	Green	Green	Green	Yellow	Yellow
	Improbable	Green	Green	Green	Green	Yellow
		Negligible	Minor	Major	Critical	Catastrophic
		Consequence				

Figure 6: Risk Assessment Matrix for Fire in Hangar 1 *with* Special Hazard Fire Suppression Systems

Comparison of the Two Options

Both (*with & without*) risk matrixes in Figures 4 and 6 are combined into one risk assessment matrix shown here (Figure 7).

Likelihood	Likely	Yellow	Yellow	Red	Red	Red
	Probable	Green	Yellow	Yellow	Red	Red
	May Occur	Green	With Special Hazard Fire Suppression System	With or Without Special Hazard Fire Suppression System	Yellow	Red
	Unlikely	Green	Green	Green	With or Without Special Hazard Fire Suppression System	Yellow
	Improbable	Green	Green	Green	Green	With or Without Special Hazard Fire Suppression System
		Negligible	Minor	Major	Critical	Catastrophic
		Consequence				

Figure 7: Fire Risk Assessment Matrix for Hangar 1

Examination of the risk matrix shows that there is very little qualitative difference between the two options in terms of their highest severity risk — they both are yellow reflecting a medium level of risk. In most ARC applications, this risk can be accepted by a project with suitable examination of the accident sequences and their risk management plan.

Assessing Aircraft Initiated Fire Risks in the Hangar

This section assesses the aircraft initiated risk of a “Major fire in Hangar 1.” The event tree is shown in Figure 8.

The initiating event is that a local fire starts in an aircraft that is stored in the hangar. This is assessed to be “Probable” in the life of the hangar. Local fire detection occurs with a high probability. When detected, the NASA/Ames Emergency Dispatch Center is alerted. If the local fire fighting is effective, it results in sequence #1 with a “Minor Damage” consequence and a “Probable” likelihood in the life of the hangar. Event sequence #1 occurs whether or not there is a Special Hazard Fire Suppression System and this risk is shown in the risk assessment matrix of Figure 1.

Event sequence #2 occurs if local fire fighting is ineffective and it results in a “Major fire in Hangar 1.” Event sequence #3 occurs if the fire is not detected in time so that it results in a “Major fire in Hangar 1.” These two event sequences shows that an aircraft related fire initiating event can spread and become a “Major fire in Hangar 1” with a “May Occur” likelihood in the life of hangar. These sequences feed the initiating event in event trees of Figures 3 and 5. These results partly justify the likelihood assessment of “May Occur” for the initiating event in “Fire Risk in Hangar 1 *without* any Special Hazard Fire Suppression System” (Figure 3) and “Fire Risk in Hangar 1 *with* a Special Hazard Fire Suppression System” (Figure 5).

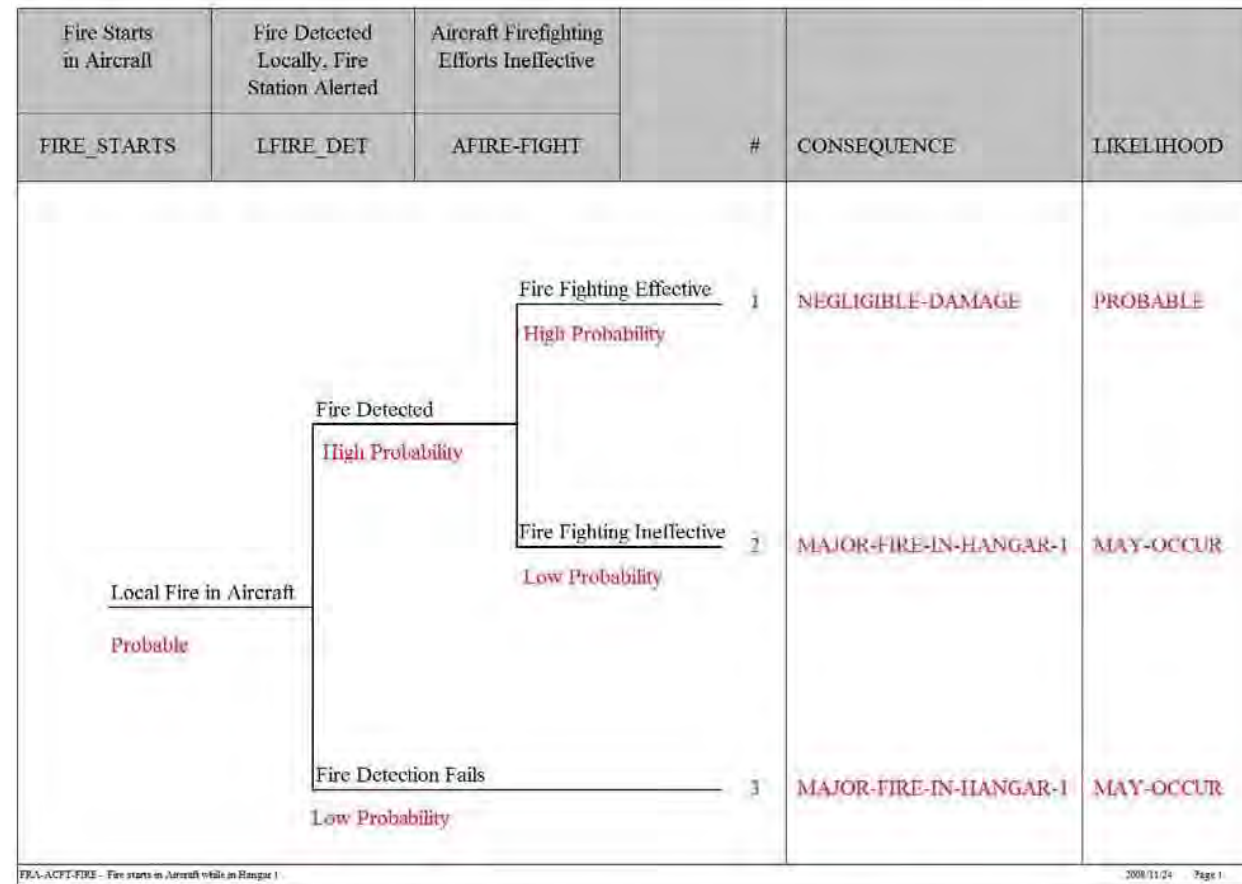

Figure 8: Event Tree for Aircraft Initiated New Hangar 1 Fire Risk

Note that the event tree of Figure 8 does not include the NASA/Ames Fire Department's effectiveness in fighting the fire — they are included in the event trees of Figures 3 and 5.

Assessing Airship Initiated Fires in the Hangar

This section assesses an airship initiated risk of a “Major fire in Hangar 1.” The event tree is shown in Figure 9 and is similar to that of the event tree for the aircraft initiated fire (Figure 8).

The initiating event is that a local fire starts in an airship that is stored in the hangar. This is assessed to be “May Occur”. This is a lower likelihood than for the initiating event of a local fire starts in an aircraft (shown in Figure 8) which was assessed to be “Probable”. The lower likelihood is because of the smaller quantities of fuel and other flammable materials in an airship. The lower complexity of an airship is also assessed to have lower likelihood of an ignition source.

Local fire detection occurs with a high probability. When detected, the NASA/Ames Emergency Dispatch Center is alerted. If the local fire fighting is effective, it results in sequence #1 with a “Minor damage” consequence and a “May Occur” likelihood. Event sequence #1 occurs whether or not there is a Special Hazard Fire Suppression System. This risk is not shown in Figure 1 since it is lower than the similar risk from an aircraft (see Figure 8).

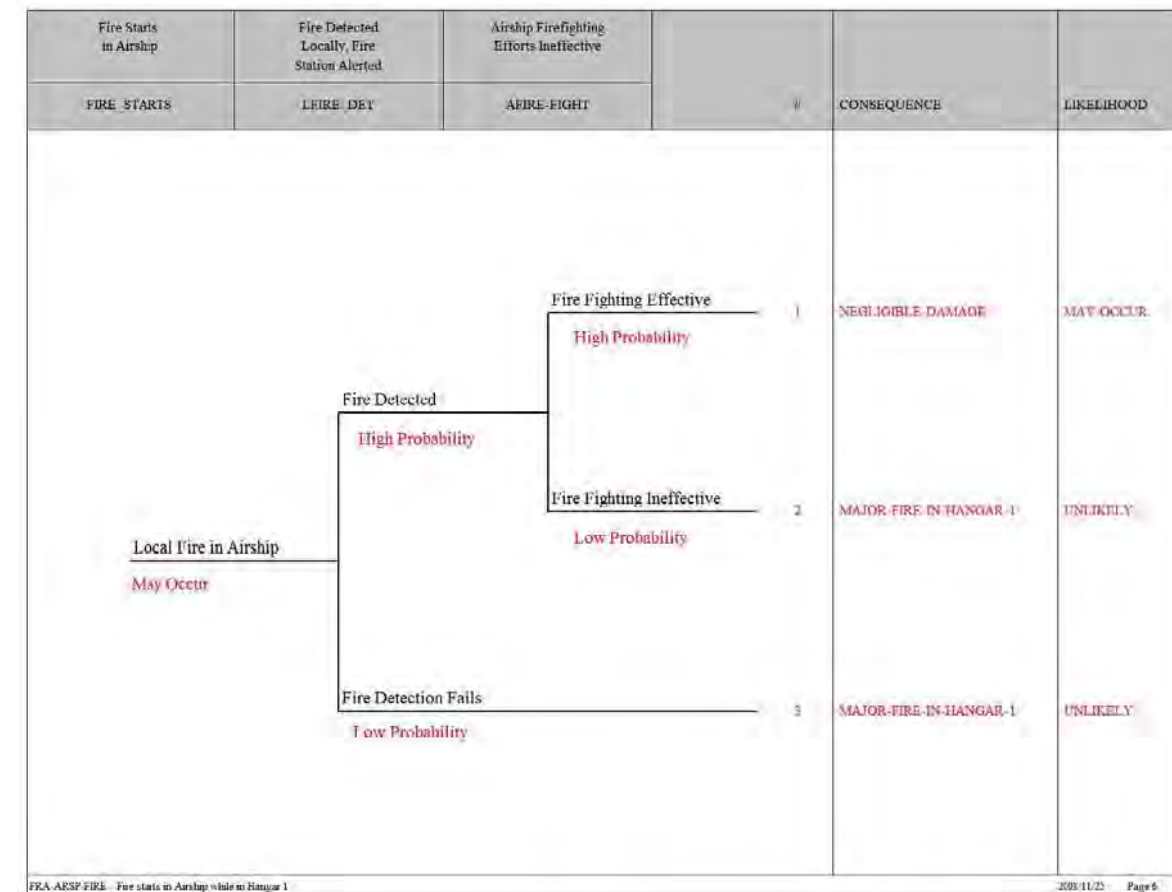

Figure 9: Event Tree for Airship Initiated New Hangar 1 Fire Risk

Event sequence #2 occurs if local fire fighting is ineffective and it results in a “Major fire in Hangar 1”. Event sequence #3 occurs if the fire is not detected in time so that it results in a “Major fire in Hangar 1”. These two event sequences show that an airship related fire initiating

event can spread and become a “Major fire in Hangar 1” with an “Unlikely” likelihood of occurrence. These sequences feed the initiating event in event trees of Figures 3 and 5. The “Unlikely” likelihood is much lower, and hence, a subset of the “May occur” likelihood for the initiating events of Figures 3 and 5. Recall from the previous section that the higher likelihood is driven by the aircraft initiated fire risk (so far).

Assessing Short Term Special Event Fire Risks in the Hangar

This section assesses the risk of a “Major fire in Hangar 1” due to special events such as public engagements. The event tree is shown in Figure 10. It is also assumed that the likelihood of fire during the construction of the Special Event infrastructure is no greater than the likelihood of a fire starting during the Special Event itself.

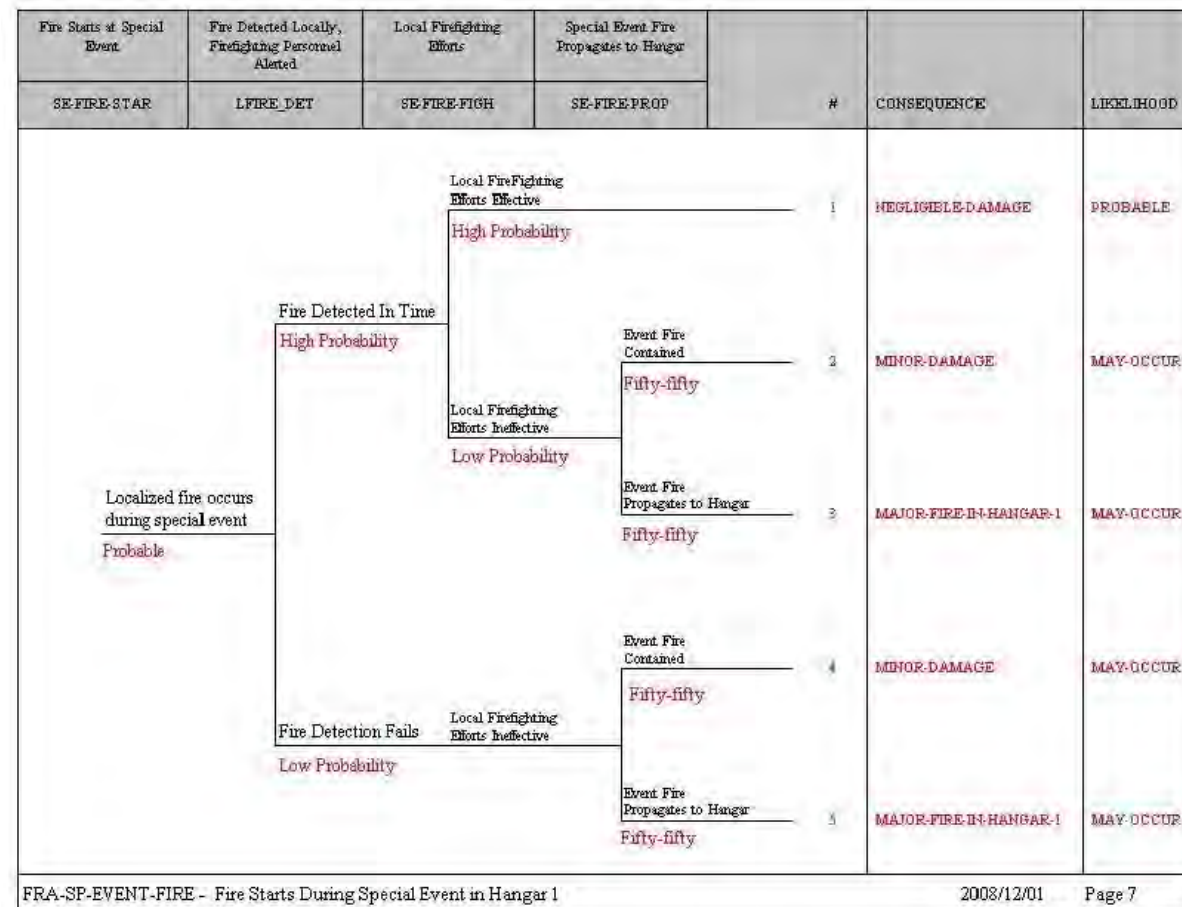

Figure 10: Event Tree for Special Event Initiated Hangar 1 Fire Risk

The initiating event of the Figure 10 event tree is that a localized small fire that occurs during the course of the special event. Due to the nature of special events, there can be multiple ignition

sources and a varying amount of combustible material. The likelihood of occurrence of the localized fire was judged to be “Probable” in the life of the hangar. Since there is a large variation in the frequency and type of special events there is some uncertainty around this value. However, this study assumes that the special events will be reviewed and approved by the NASA/Ames Construction Permit Review Board (CPRB) and monitored by fire protection and safety personnel thus providing confidence in the “Probable” likelihood.

Local fire detection occurs with a high probability. When detected, the NASA/Ames Emergency Dispatch Center is alerted. In addition, the local personnel have access to and use the available fire suppression systems. If the local fire fighting is effective (sequence #1, Figure 10), it was judged to result in a “Negligible Damage” consequence and a “Probable” likelihood in the life of the hangar.

If local firefighting is ineffective there is a chance (assessed as fifty-fifty) that the fire will not spread to the rest of the hangar (sequence #2, Figure 10). The fire may lack sufficient combustible materials, or have barriers or have separation. This scenario was judged to have a “Minor damage” consequence and a “May occur” likelihood in the life of the hangar. Conversely, if fire spreads to nearby to aircraft/airship/hangar combustible material it could result in a “Major fire in Hangar 1” (sequence #3, Figure 10). This risk of this scenario (sequence #3), could be reduced to a lower likelihood if there are sufficient firebreaks between the special event location and the aircraft/airship/hangar, but the fifty-fifty chance is a conservative assumption.

If the fire is not detected in time, (and event with low probability of occurrence), then there is no local fire fighting. The fire either spreads in Hangar 1 or is contained on a fifty-fifty chance. The former leads to a “Major fire in Hangar 1” with “May occur” likelihood in the life of the hangar (sequence #5, Figure 10); while the latter leads to “Minor damage” with “May occur” likelihood (sequence #4, Figure 10).

Event sequences #3 and #5 represent the worst-case and feed the initiating event in higher level event trees of Figures 3 and 5. These results show that the likelihood assessment of “May Occur” for the initiating event in “Fire Risk in Hangar 1 Without any Special Hazard Fire Suppression System” (Figure 3) and “Fire Risk in Hangar 1 With a Special Hazard Fire Suppression System” (Figure 5) are a result of aircraft initiated fires and special event fires.

Event sequences #1, 2, and 4 occur whether or not there is a Special Hazard Fire Suppression System. These risks are also shown in Figure 1.

Appendix G: Structural Retrofit Requirements

Table of Contents

End Section

RISA-3D Graphics

Graphics for Seismic Analysis

Graphics for Wind analysis

Graphics for Braces between A- Frames (Wind / seismic)

Table A – Retrofit Estimate / Type

Middle Section

RISA-3D Graphics

Graphics for Seismic Analysis

Graphics for Wind analysis

Graphics for Braces between A- Frames (Wind / seismic)

Table B – Retrofit Estimate / Type

Summary Table of Quantity Estimate

Graphic Showing Displacement at Top of A-Frame and Top of Arches



Code Check	
Black	No Calc
Red	> 1.0
Green	.90-1.0
Yellow	.75-.90
Cyan	.50-.75

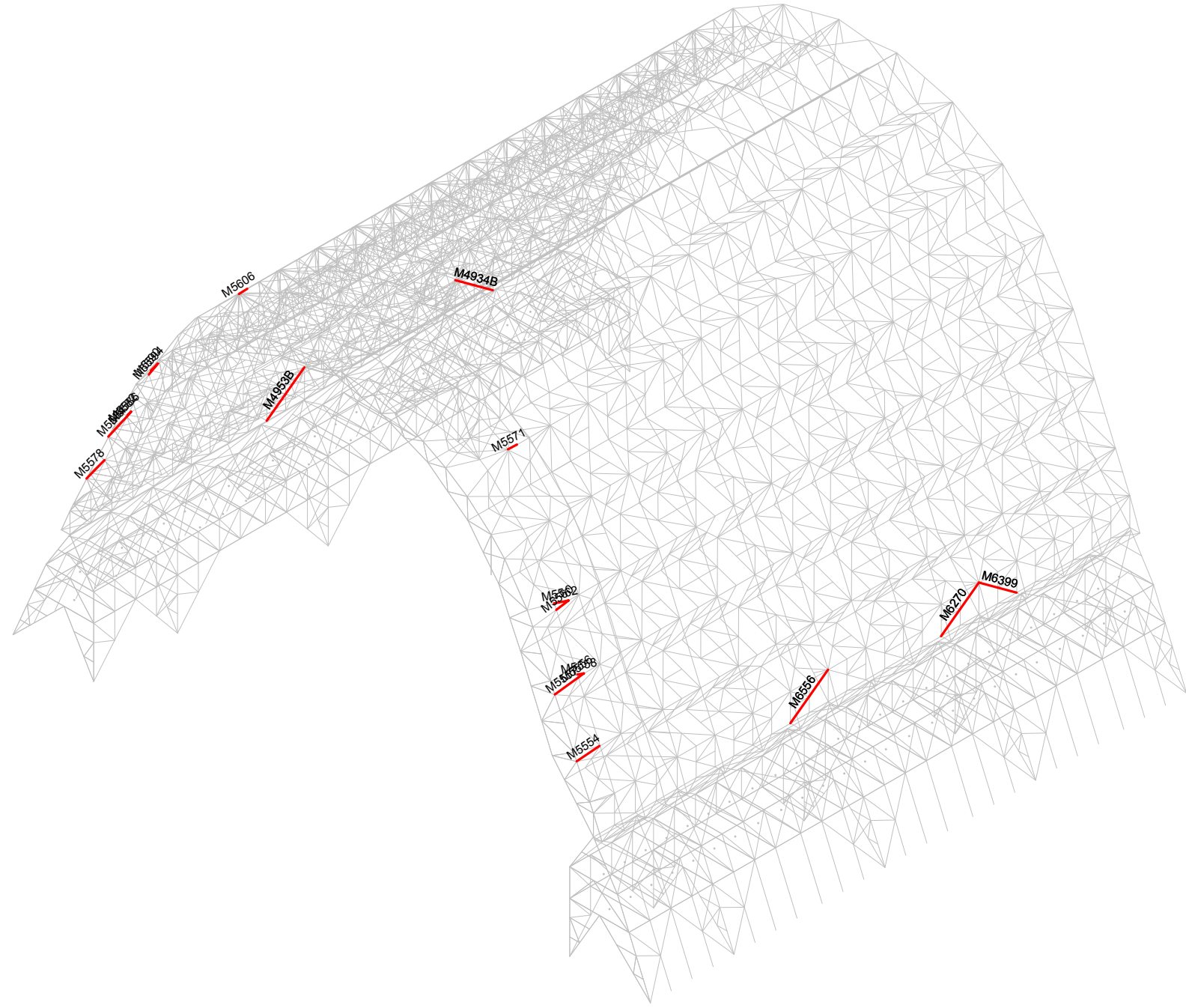

Solution: Envelope

ExelTech
AJC
1123

Hangar 1 South Section
End Section Arches and Above A-Frame Seismic Envelope Label

SK - 1
Nov 2, 2011 at 4:31 PM
Hangar End_Site Arches and above A Frames_20111030.r3d



Code Check	
Black	No Calc
Red	> 1.0
Green	.90-1.0
Cyan	.75-.90
Blue	0-.75

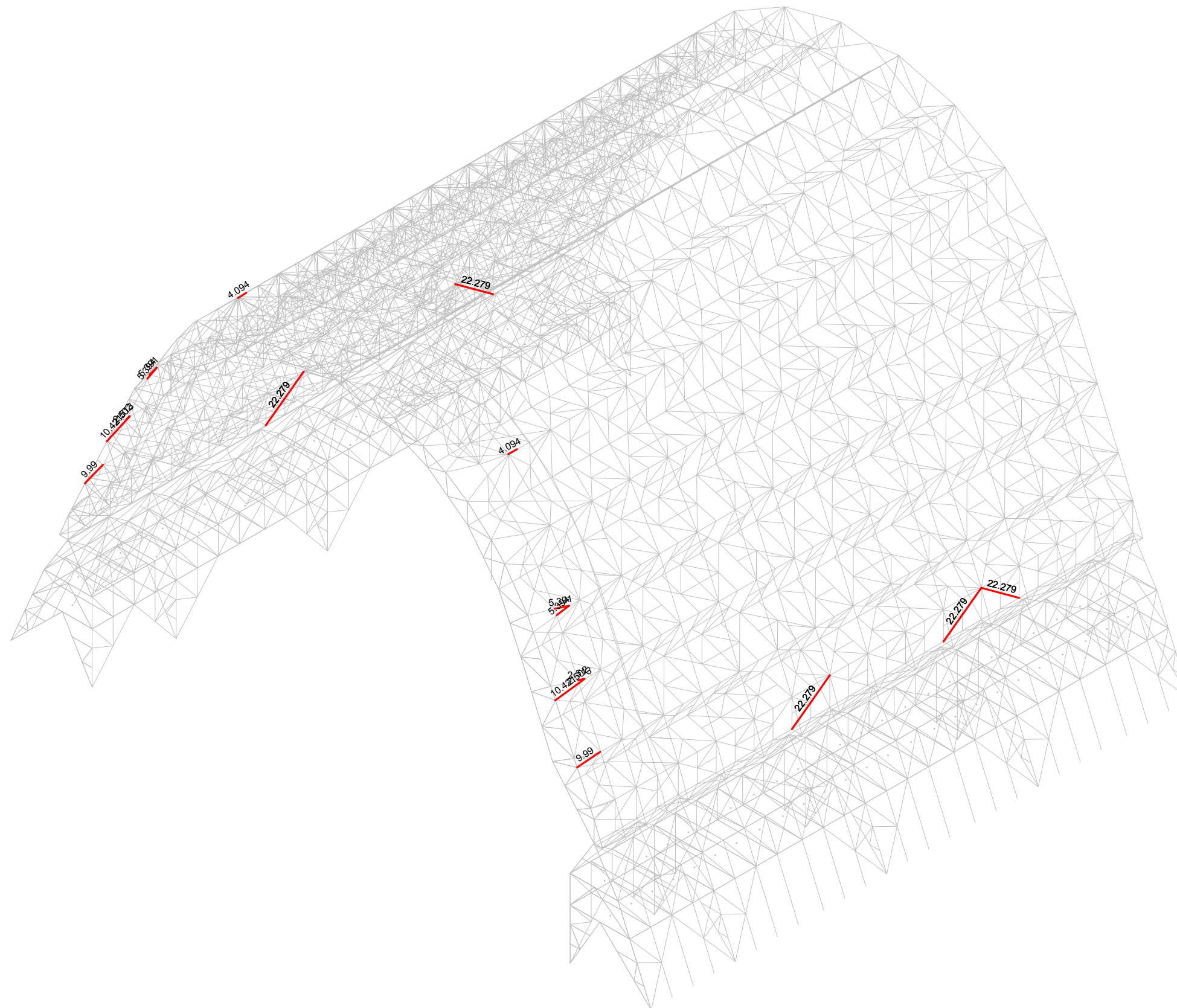

Member Length (ft) Displayed
Solution: Envelope

ExelTech	Hangar 1 South Section End Section Arches and Above A-Frame Seismic Envelope Length	SK - 4
AJC		Nov 2, 2011 at 1:14 PM
1123		Hangar End_Site Arches and above A Frames_20111030.r3d

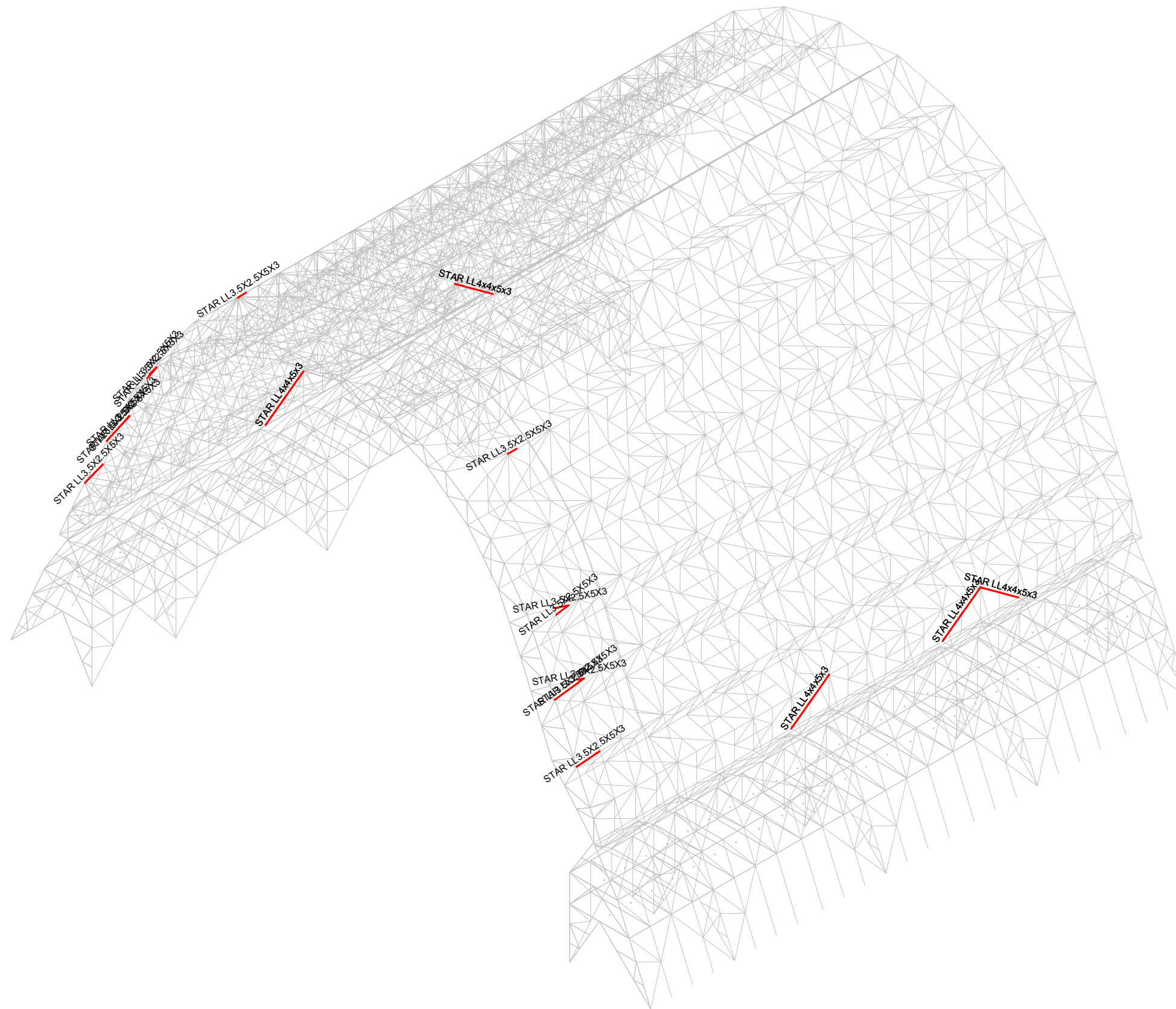
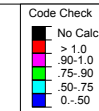

Solution: Envelope

ExelTech
AJC
1123

Hangar 1 South Section
End Section Arches and Above A-Frame Seismic Envelope Shape

SK - 3
Nov 2, 2011 at 1:13 PM
Hangar End_Site Arches and above A Frames_20111030.r3d

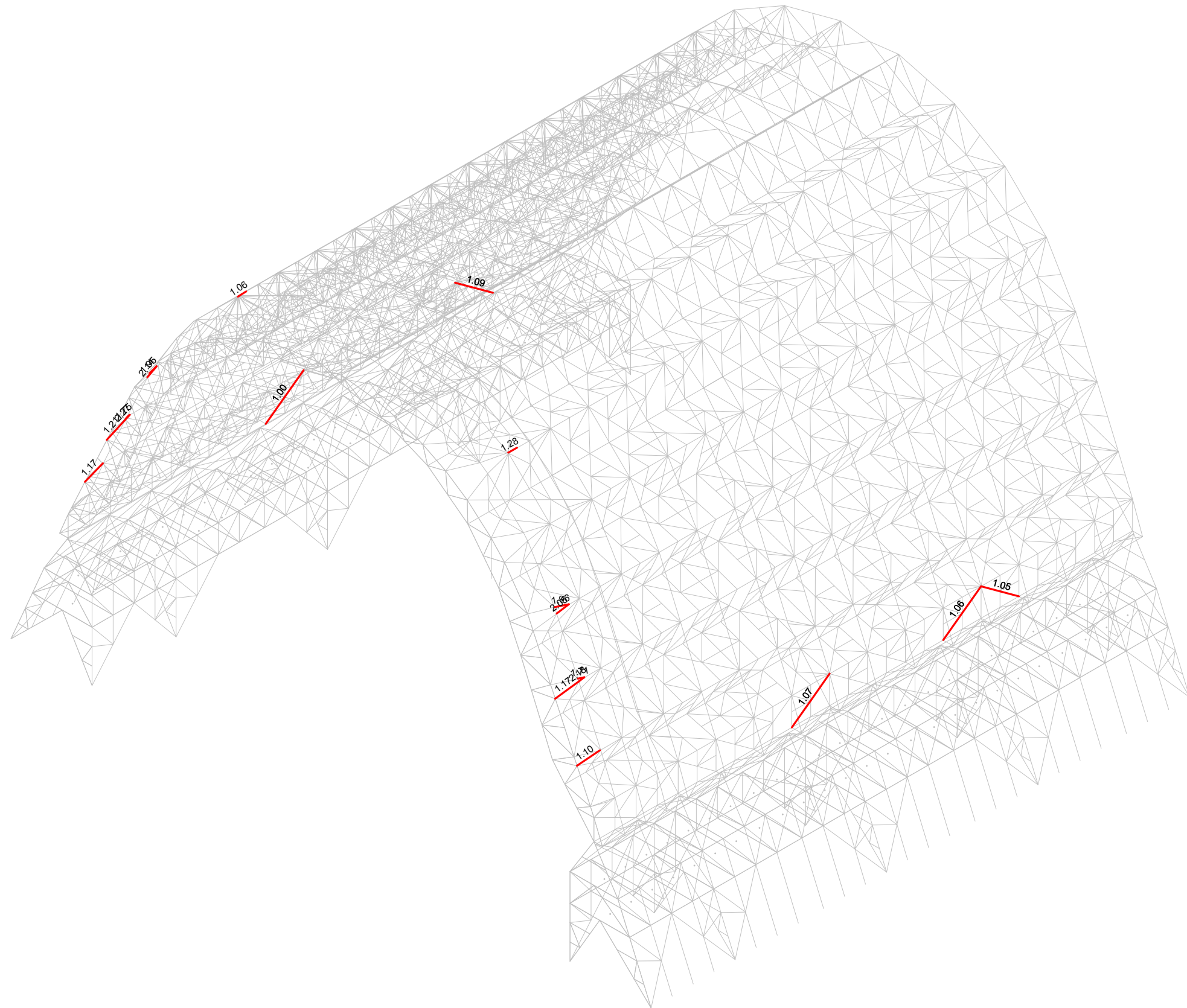
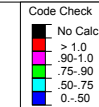

Member Code Checks Displayed
Solution: Envelope

ExelTech
AJC
1123

Hangar 1 South Section
End Section Arches and Above A-Frame Seismic Envelope Unity

SK - 1
Nov 2, 2011 at 1:09 PM
Hangar End_Site Arches and above A Frames_20111030.r3d



Code Check	
■	No Calc
■	> 1.0
■	.90-1.0
■	.75-.90
■	.50-.75
■	0-.50

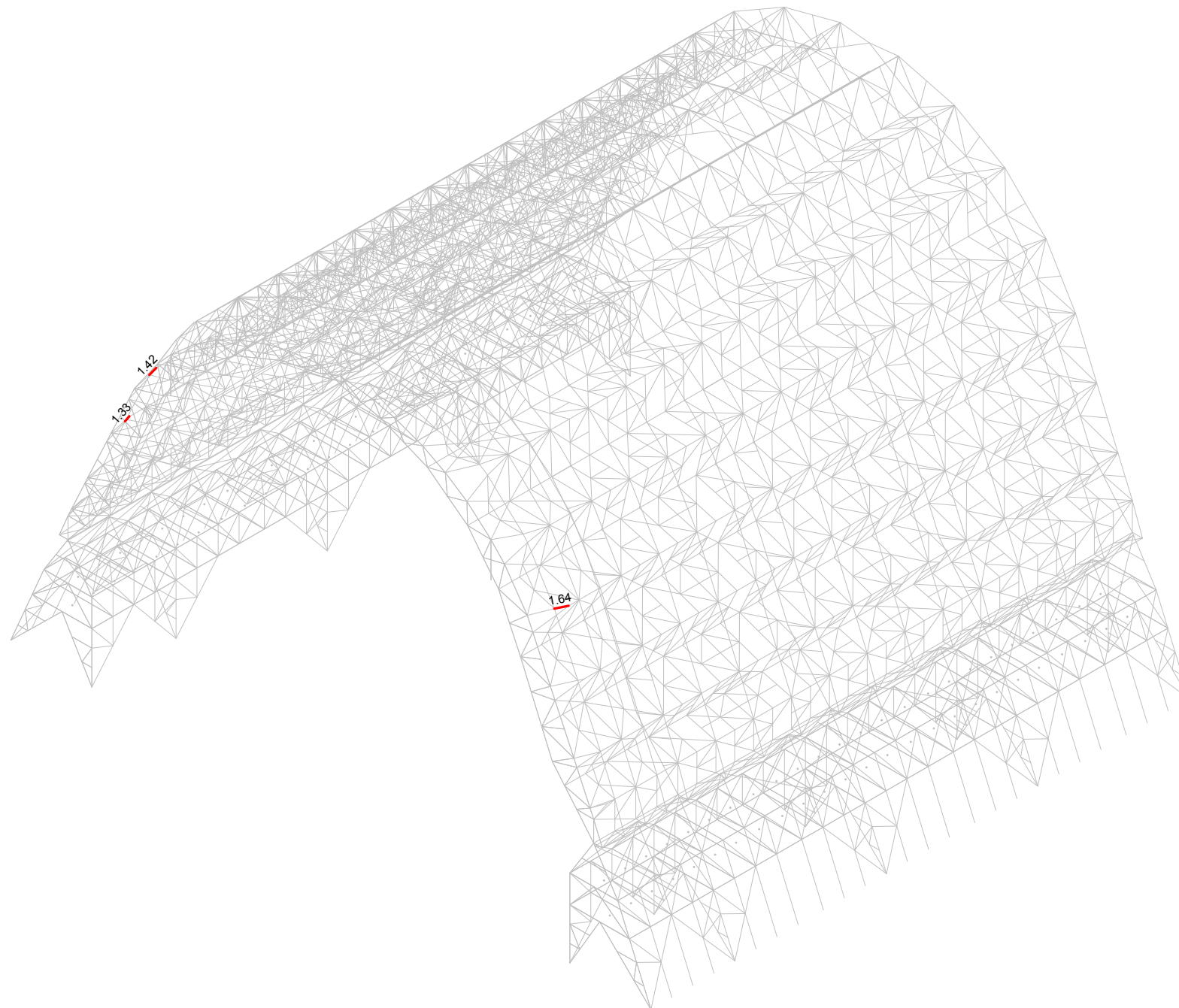

Member Code Checks Displayed
Solution: Envelope

ExelTech	Hangar 1 South Section End Section Above A-Frame Wind Category II Unity	SK - 2
AJC		Nov 2, 2011 at 9:48 AM
1123		Hangar End_Site Arches and above A Frames_20111030.r3d



Code Check

No Calc
> 1.0
.90-1.0
.75-.90
.50-.75
0-.50

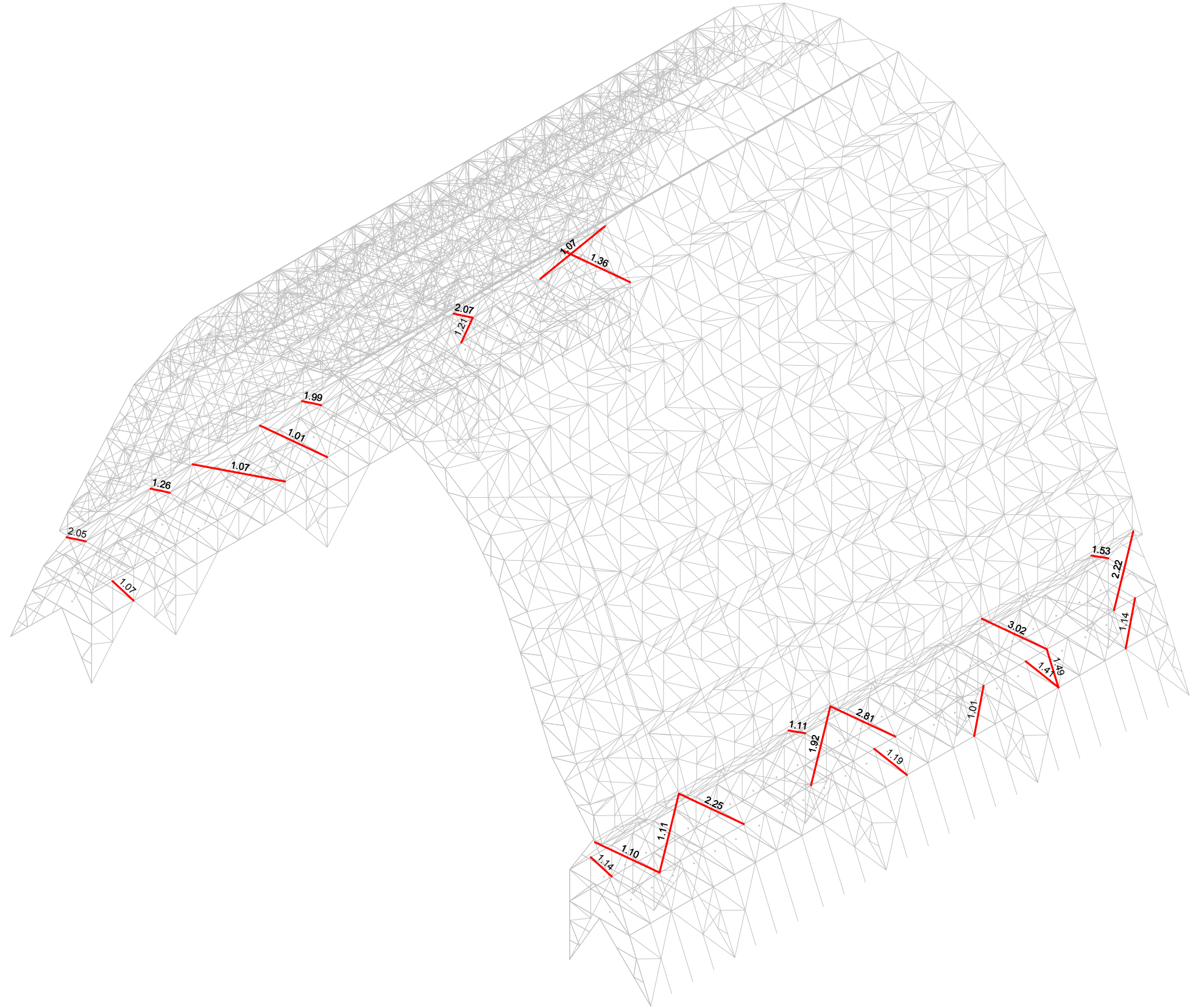

Member Code Checks Displayed
Solution: Envelope

ExelTech
AJC
1123

Hangar 1 South Section
End Section Above A-Frame Wind Category II Unity

SK - 6
Nov 2, 2011 at 3:55 PM
Hangar End_Site Between A Frames_20111028.r3d



Code Check	
■	No Calc
■	> 1.0
■	.90-1.0
■	.75-.90
■	.50-.75
■	0-.50

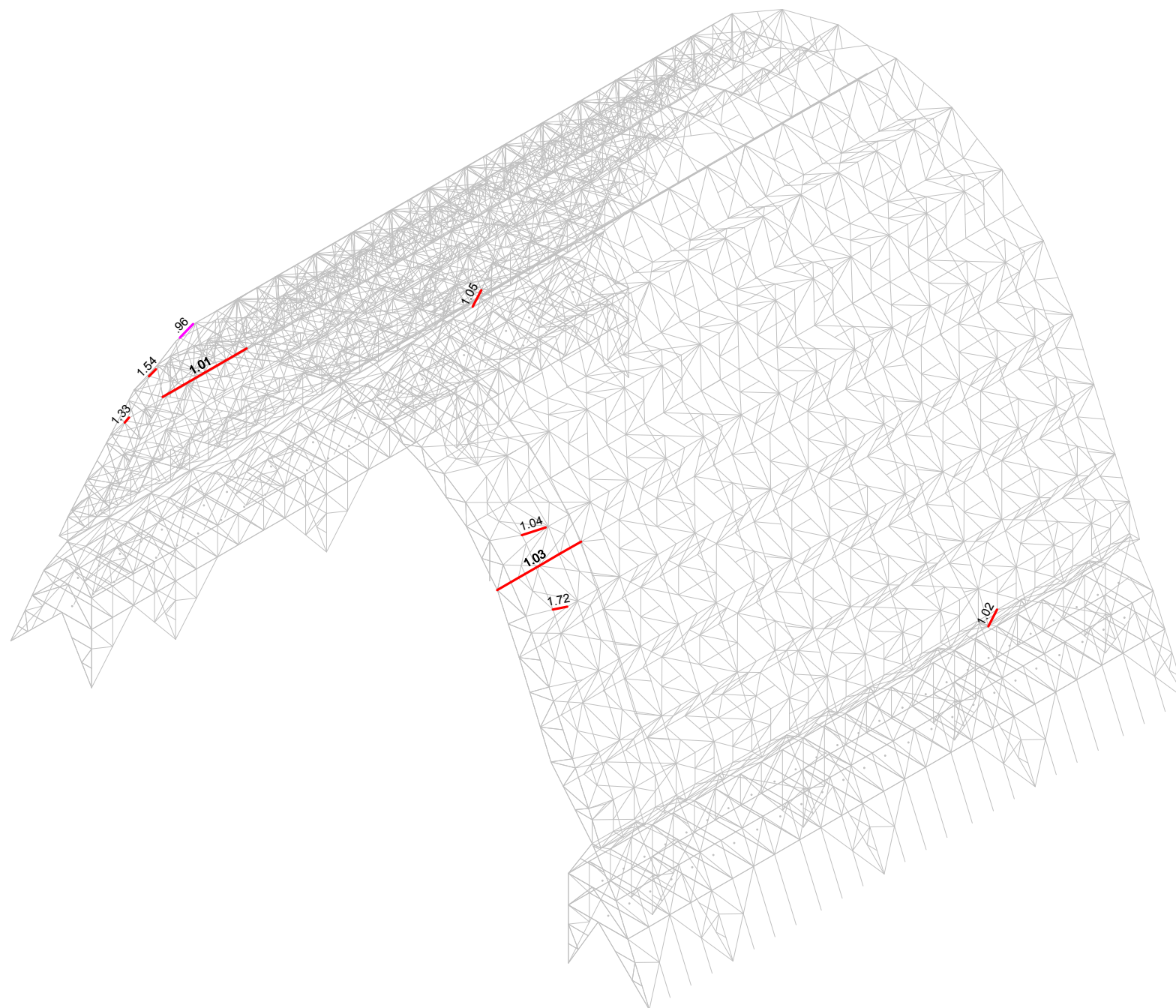

Member Code Checks Displayed
Solution: Envelope

ExelTech
AJC
1123

Hangar 1 South Section
End Section Above A-Frame Wind Category III Unity

SK - 1
Nov 2, 2011 at 9:10 AM
Hangar End_Site Arches and above A Frames_20111030.r3d



Code Check	
Black	No Calc
Red	> 1.0
Green	.90-1.0
Cyan	.75-.90
Blue	0-.75

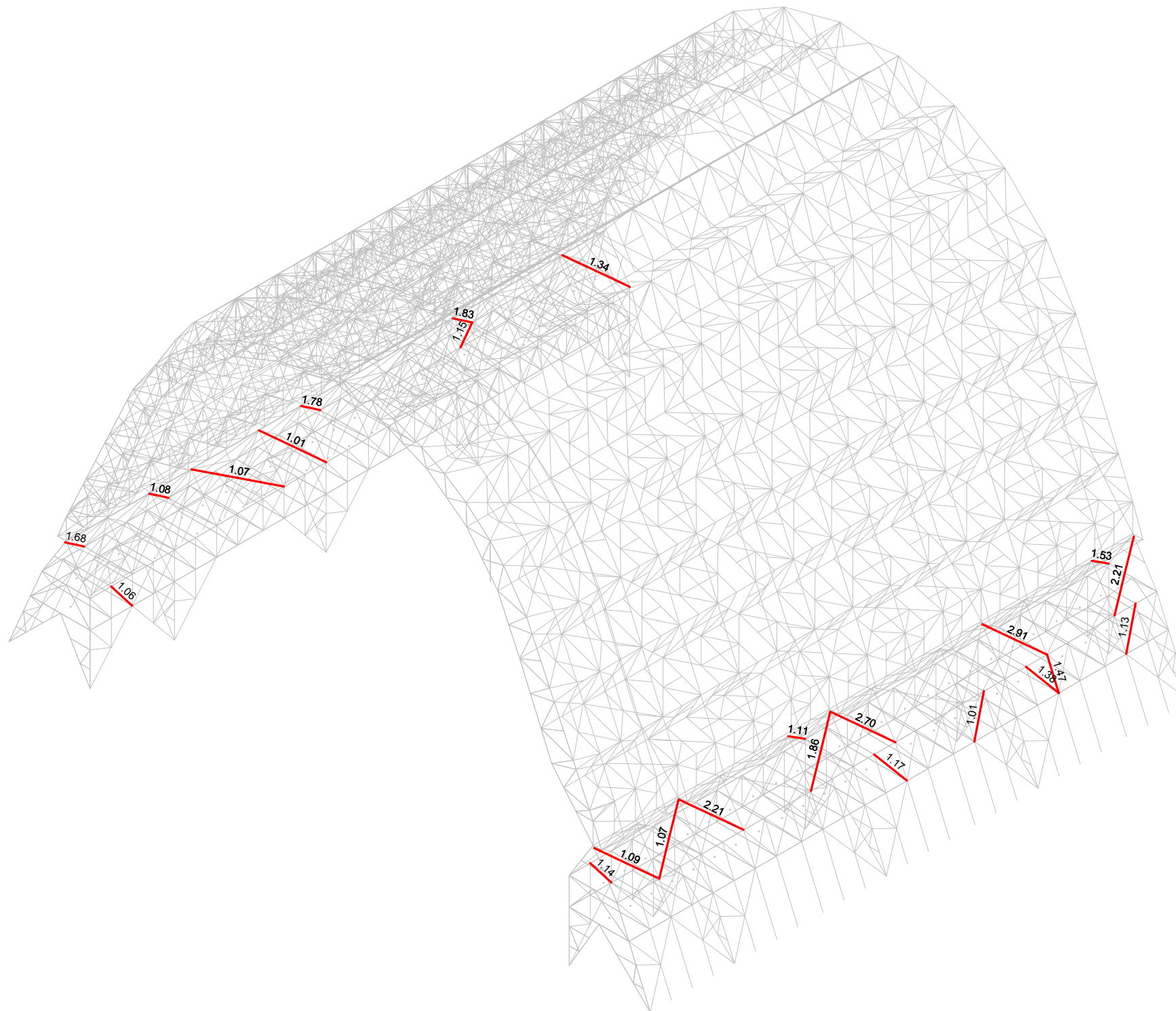

Member Code Checks Displayed
Solution: Envelope

ExelTech
AJC
1123

Hangar 1 South Section
End Section Between A-Frame Wind Category III Unity

SK - 5
Nov 2, 2011 at 3:34 PM
Hangar End_Site Between A Frames_20111028.r3d



Code Check	
■	No Calc
■	> 1.0
■	.90-1.0
■	.75-.90
■	.50-.75
■	0-.50

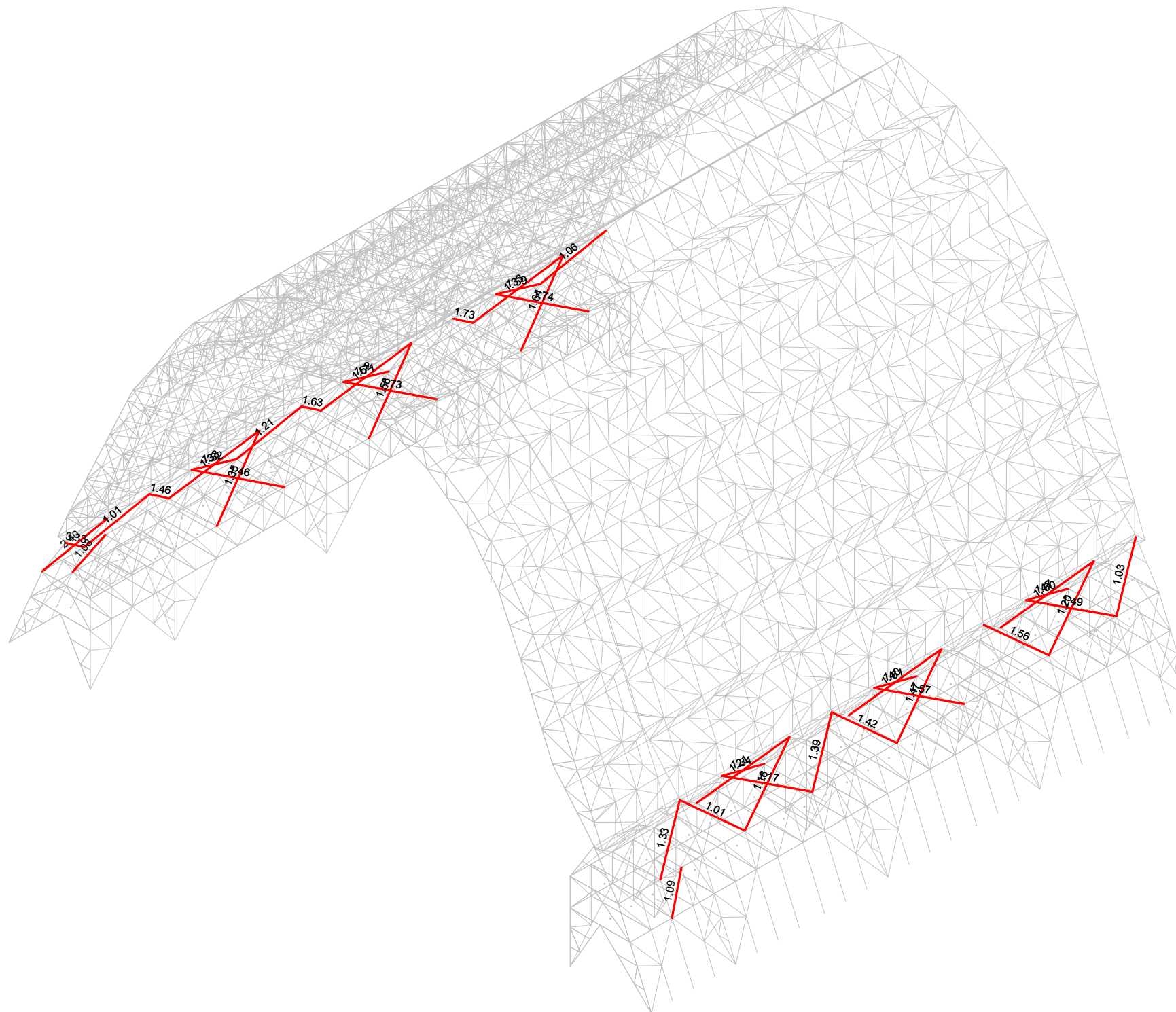

Member Code Checks Displayed
Solution: Envelope

ExelTech
AJC
1123

Hangar 1 South Section
End Section Between A-Frame Seismic Envelope Unity

SK - 1
Nov 2, 2011 at 2:04 PM
Hangar End_Site Between A Frames_20111028.r3d



Code Check	
No Calc	
> 1.0	Red
.90-1.0	Orange
.75-.90	Yellow
.50-.75	Green
0-.50	Blue

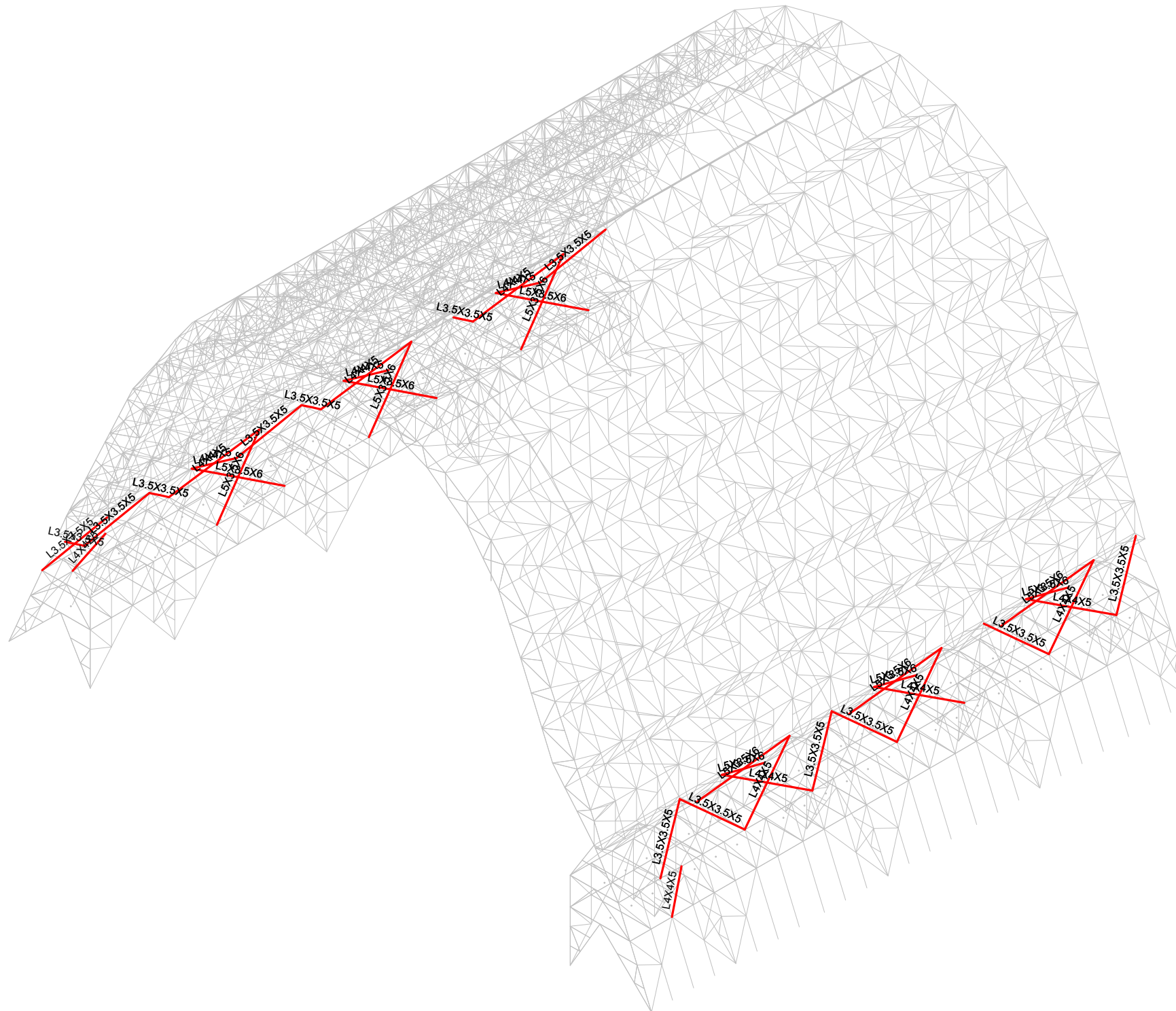

Solution: Envelope

ExelTech
AJC
1123

Hangar 1 South Section
End Section Between A-Frame Seismic Envelope Shape

SK - 2
Nov 2, 2011 at 2:37 PM
Hangar End_Site Between A Frames_20111028.r3d



Code Check	
■	No Calc
■	> 1.0
■	.90-1.0
■	.75-.90
■	.50-.75
■	0-.50

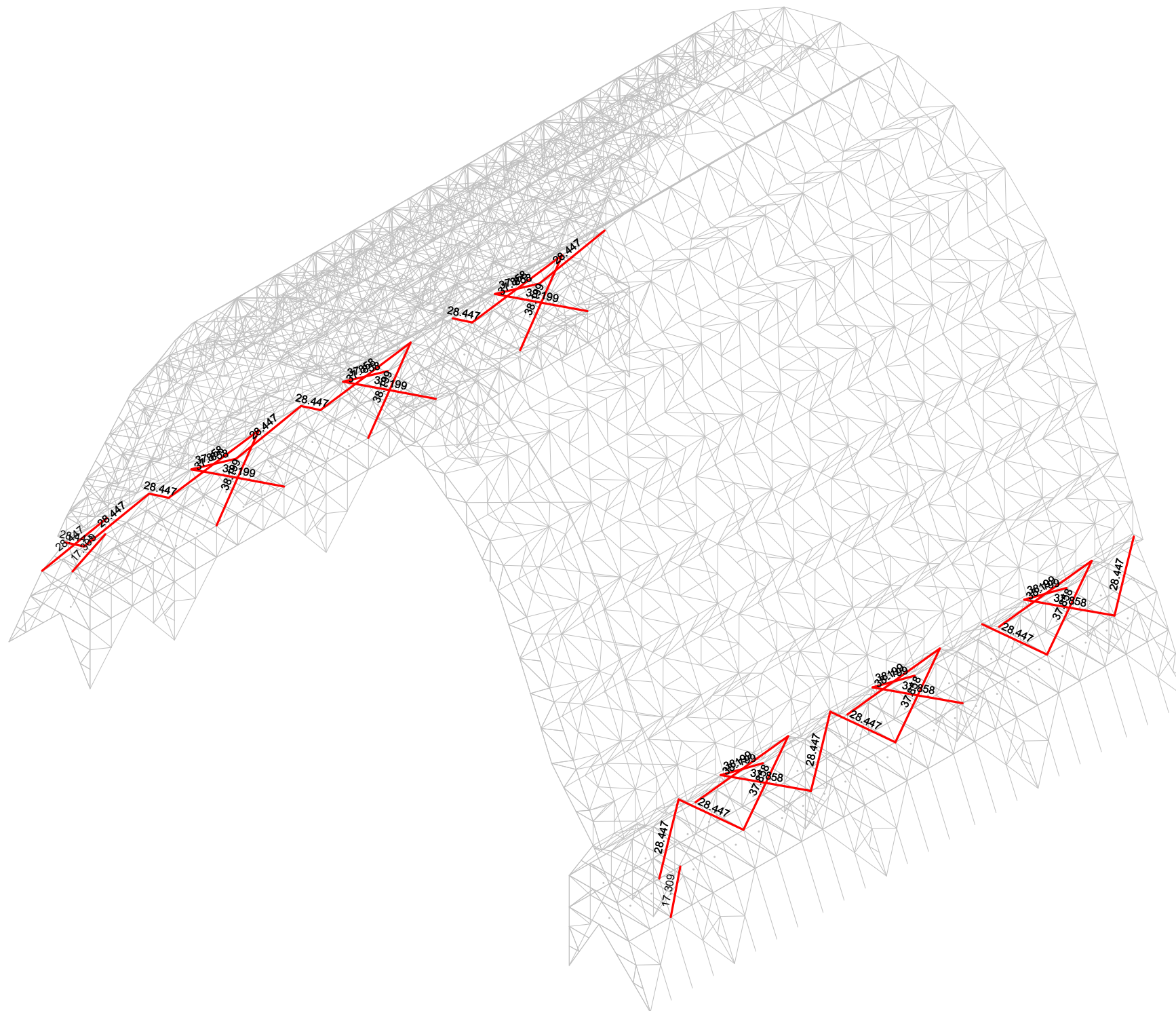

Member Length (ft) Displayed
Solution: Envelope

ExelTech
AJC
1123

Hangar 1 South Section
End Section Between A-Frame Seismic Envelope Length

SK - 4
Nov 2, 2011 at 3:16 PM
Hangar End_Site Between A Frames_20111028.r3d



Code Check	
Black	No Calc
Red	> 1.0
Green	.90-1.0
Cyan	.75-90
Blue	0-.50

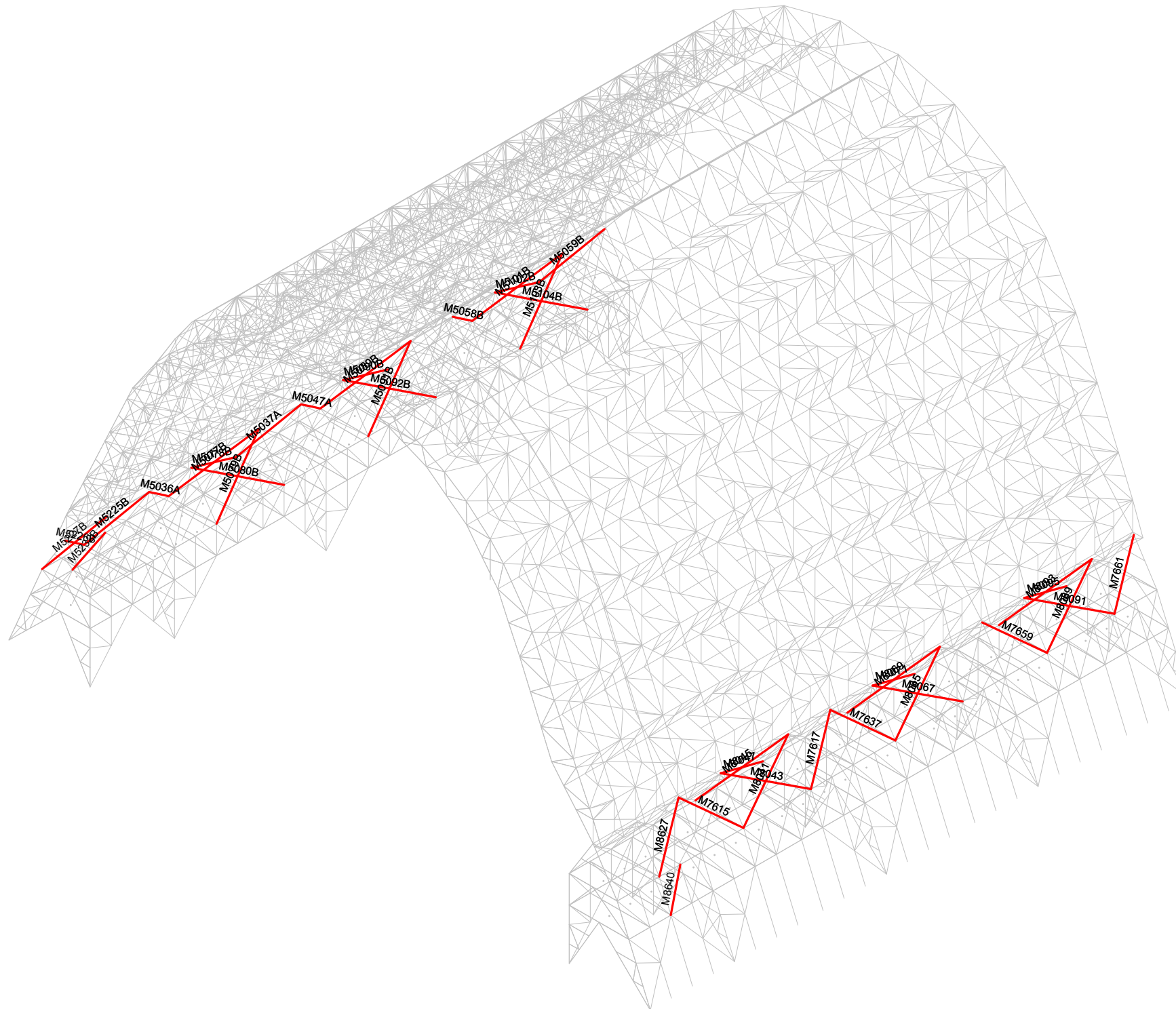

Solution: Envelope

ExelTech
AJC
1123

Hangar 1 South Section
End Section Between A-Frame Seismic Envelope Label

SK - 3
Nov 2, 2011 at 3:15 PM
Hangar End_Site Between A Frames_20111028.r3d

HANGAR 1

Retrofit Quantity Estimate

Table A (End Section)

Members Above A-Frame under Seismic Loads

	Existing Member			New Member					
	Member ID	Shape	Length	Shape	Area	Unit length Weight (plf)	Length	Weight of Member (lb)	Type
1	M5582	STAR LL3.5X2.5X5/16	2.5	LL3x3x5/16	3.55	12.1	2.5	30	IV
2	M5556	STAR LL3.5X2.5X5/16	2.5	LL3x3x5/16	3.55	12.1	2.5	30	IV
3	M5590	STAR LL3.5X2.5X5/16	5.5	LL3x3x5/16	3.55	12.1	5.5	67	IV
4	M5560	STAR LL3.5X2.5X5/16	5.5	LL3x3x5/16	3.55	12.1	5.5	67	IV
5	M5562	STAR LL3.5X2.5X5/16	5.5	LL3x3x5/16	3.55	12.1	5.5	67	IV
6	M5594	STAR LL3.5X2.5X5/16	5.5	LL3x3x5/16	3.55	12.1	5.5	67	IV
7	M5586	STAR LL3.5X2.5X5/16	2.5	LL3x3x5/16	3.55	12.1	2.5	30	IV
8	M5558	STAR LL3.5X2.5X5/16	2.5	LL3x3x5/16	3.55	12.1	2.5	30	IV
9	M5571	STAR LL3.5X2.5X5/16	4	LL3x3x5/16	3.55	12.1	4.0	48	IV
10	M5584	STAR LL3.5X2.5X5/16	10.5	LL3x3x5/16	3.55	12.1	10.5	127	IV
11	M5557	STAR LL3.5X2.5X5/16	10.5	LL3x3x5/16	3.55	12.1	10.5	127	IV
12	M5578	STAR LL3.5X2.5X5/16	10	LL3x3x5/16	3.55	12.1	10.0	121	IV
13	M5554	STAR LL3.5X2.5X5/16	10	LL3x3x5/16	3.55	12.1	10.0	121	IV
14	M5606	STAR LL3.5X2.5X5/16	4	LL3x3x5/16	3.55	12.1	4.0	48	IV
	Subtotal						81.0	980	
1	M6556	STAR LL4x4x5/16	22.28	LL3x3x5/16	3.55	12.1	22.3	270	IV
2	M6270	STAR LL4x4x5/16	22.28	LL3x3x5/16	3.55	12.1	22.3	270	IV
3	M6399	STAR LL4x4x5/16	22.28	LL3x3x5/16	3.55	12.1	22.3	270	IV
4	M4953B	STAR LL4x4x5/16	22.28	LL3x3x5/16	3.55	12.1	22.3	270	IV
5	M4934B	STAR LL4x4x5/16	22.28	LL3x3x5/16	3.55	12.1	22.3	270	IV
	Subtotal						111.4	1350.0	

Members Above A-Frame under Wind Loads

1	M5630	STAR LL3.5x3.5x3/8	20.202	LL3x3x5/16	3.55	12.1	20.2	244	IV
2	M5637	STAR LL3.5x3.5x3/8	20.202	LL3x3x5/16	3.55	12.1	20.2	244	IV
3	M5562	STAR LL3.5x3.5x3/8	5.4	LL3x3x5/16					
4	M5594	STAR LL3.5x3.5x3/8	5.4	LL3x3x5/16					
5	M5582	STAR LL3.5x3.5x3/8	5.4	LL3x3x5/16	3.55	12.1	5.4	65	IV
6	M5556	STAR LL3.5x3.5x3/8	5.4	LL3x3x5/16					IV
7	M5566	STAR LL3.5x3.5x3/8	9	LL3x3x5/16	3.55	12.1	9.0	109	IV
8	M5560	STAR LL3.5x3.5x3/8	5.4	LL3x3x5/16					
9	M5558	STAR LL3.5x3.5x3/8	5.4	LL3x3x5/16					
10	M5601	STAR LL3.5x3.5x3/8	10.2	LL3x3x5/16	3.55	12.1	10.2	123	IV
11	M5630	STAR LL3.5x3.5x3/8	20.202	LL3x3x5/16	3.55	12.1	20.2	244	IV
12	M5637	STAR LL3.5x3.5x3/8	20.202	LL3x3x5/16	3.55	12.1	20.2	244	IV
13	M5562	STAR LL3.5x3.5x3/8	5.4	LL3x3x5/16					
14	M5594	STAR LL3.5x3.5x3/8	5.4	LL3x3x5/16					
15	M5582	STAR LL3.5x3.5x3/8	5.4	LL3x3x5/16	3.55	12.1	5.4	65	IV
16	M5556	STAR LL3.5x3.5x3/8	5.4	LL3x3x5/16					

HANGAR 1
Retrofit Quantity Estimate

	Existing Member			New Member					
	Member ID	Shape	Length	Shape	Area	Unit length Weight (plf)	Length	Weight of Member (lb)	Type
17	M5566	STAR LL3.5x3.5x3/8	9	LL3x3x5/16	3.55	12.1	9.0	109	IV
18	M5560	STAR LL3.5x3.5x3/8	5.4	LL3x3x5/16					
19	M5558	STAR LL3.5x3.5x3/8	5.4	LL3x3x5/16					
20	M5601	STAR LL3.5x3.5x3/8	10.2	LL3x3x5/16	3.55	12.1	10.2	123	IV
	Subtotal						130.0	1570.0	
1	M8529	L3.5X3.5X5/16	10.2	L3.5x3.5x5/16	2.02	7.2	10.2	73	I
2	M5195B	L3.5X3.5X5/16	10.2	L3.5x3.5x5/16	2.02	7.2	10.2	73	I
3	M8529	L3.5X3.5X5/16	10.2	L3.5x3.5x5/16	2.02	7.2	10.2	73	I
4	M5195B	L3.5X3.5X5/16	10.2	L3.5x3.5x5/16	2.02	7.2	10.2	73	I
	Subtotal						40.8	292.0	

Members Below A-Frame under Seismic Loads

1	M5226B	L3.5X3.5X5/16	28.447	L3.5x3.5x5/16	2.02	7.2	28.4	205	I
2	M5227B	L3.5X3.5X5/16	28.447	L3.5x3.5x5/16	2.02	7.2	28.4	205	I
3	M5058B	L3.5X3.5X5/16	28.447	L3.5x3.5x5/16	2.02	7.2	28.4	205	I
4	M5047A	L3.5X3.5X5/16	28.447	L3.5x3.5x5/16	2.02	7.2	28.4	205	I
5	M7659	L3.5X3.5X5/16	28.447	L3.5x3.5x5/16	2.02	7.2	28.4	205	I
6	M5036A	L3.5X3.5X5/16	28.447	L3.5x3.5x5/16	2.02	7.2	28.4	205	I
7	M7637	L3.5X3.5X5/16	28.447	L3.5x3.5x5/16	2.02	7.2	28.4	205	I
8	M7617	L3.5X3.5X5/16	28.447	L3.5x3.5x5/16	2.02	7.2	28.4	205	I
9	M8627	L3.5X3.5X5/16	14.367	L3.5x3.5x5/16	2.02	7.2	14.4	103	I
10	M5037A	L3.5X3.5X5/16	28.447	L3.5x3.5x5/16	2.02	7.2	28.4	205	I
11	M5059B	L3.5X3.5X5/16	28.447	L3.5x3.5x5/16	2.02	7.2	28.4	205	I
12	M7661	L3.5X3.5X5/16	28.447	L3.5x3.5x5/16	2.02	7.2	28.4	205	I
13	M5225B	L3.5X3.5X5/16	28.447	L3.5x3.5x5/16	2.02	7.2	28.4	205	I
14	M7615	L3.5X3.5X5/16	28.447	L3.5x3.5x5/16	2.02	7.2	28.4	205	I
	Subtotal						384.2	2768.0	
1	M5090B	L4X4X5/16	19.12	L4x4x5/16	2.4	8.2	19.1	157	I
2	M5089B	L4X4X5/16	37.858	L4x4x5/16	2.4	8.2	37.9	310	I
3	M5102B	L4X4X5/16	19.12	L4x4x5/16	2.4	8.2	19.1	157	I
4	M8067	L4X4X5/16	37.858	L4x4x5/16	2.4	8.2	37.9	310	I
5	M8091	L4X4X5/16	37.858	L4x4x5/16	2.4	8.2	37.9	310	I
6	M8065	L4X4X5/16	19.12	L4x4x5/16	2.4	8.2	19.1	157	I
7	M5101B	L4X4X5/16	37.858	L4x4x5/16	2.4	8.2	37.9	310	I
8	M5077B	L4X4X5/16	37.858	L4x4x5/16	2.4	8.2	37.9	310	I
9	M5078B	L4X4X5/16	19.12	L4x4x5/16	2.4	8.2	19.1	157	I
10	M8089	L4X4X5/16	19.12	L4x4x5/16	2.4	8.2	19.1	157	I
11	M8043	L4X4X5/16	37.858	L4x4x5/16	2.4	8.2	37.9	310	I
12	M8041	L4X4X5/16	19.12	L4x4x5/16	2.4	8.2	19.1	157	I
13	M8640	L4X4X5/16	17.309	L4x4x5/16	2.4	8.2	17.3	142	I
14	M5232B	L4X4X5/16	17.309	L4x4x5/16	2.4	8.2	17.3	142	I
	Subtotal						376.5	3086.0	
1	M5104B	L5X3.5X3/8	38.199	L5x3.5x3/8	3.05	10.2	38.2	390	I

HANGAR 1

Retrofit Quantity Estimate

	Existing Member			New Member					
	Member ID	Shape	Length	Shape	Area	Unit length Weight (plf)	Length	Weight of Member (lb)	Type
2	M5092B	L5X3.5X3/8	38.199	L5x3.5x3/8	3.05	10.2	38.2	390	I
3	M5103B	L5X3.5X3/8	38.199	L5x3.5x3/8	3.05	10.2	38.2	390	I
4	M8071	L5X3.5X3/8	38.199	L5x3.5x3/8	3.05	10.2	38.2	390	I
5	M8095	L5X3.5X3/8	38.2	L5x3.5x3/8	3.05	10.2	38.2	390	I
6	M5091B	L5X3.5X3/8	38.199	L5x3.5x3/8	3.05	10.2	38.2	390	I
7	M8093	L5X3.5X3/8	37.86	L5x3.5x3/8	3.05	10.2	37.9	386	I
8	M5080B	L5X3.5X3/8	38.199	L5x3.5x3/8	3.05	10.2	38.2	390	I
9	M8069	L5X3.5X3/8	38.199	L5x3.5x3/8	3.05	10.2	38.2	390	I
10	M5079B	L5X3.5X3/8	38.199	L5x3.5x3/8	3.05	10.2	38.2	390	I
11	M8047	L5X3.5X3/8	38.199	L5x3.5x3/8	3.05	10.2	38.2	390	I
12	M8045	L5X3.5X3/8	38.199	L5x3.5x3/8	3.05	10.2	38.2	390	I
	Subtotal						458.1	4676.0	

Members Below A-Frame under Wind Loads

1	M5047A	L3.5X3.5X5/16	28.447	L3.5x3.5x5/16	2.02	7.2	0.0	0	I
2	M5226B	L3.5X3.5X5/16	28.447	L3.5x3.5x5/16	2.02	7.2	0.0	0	I
3	M8628	L3.5X3.5X5/16	28.447	L3.5x3.5x5/16	2.02	7.2	28.4	205	I
4	M5036A	L3.5X3.5X5/16	28.447	L3.5x3.5x5/16					
5	M8627	L3.5X3.5X5/16	14.367	L3.5x3.5x5/16	2.02	7.2	14.4	103	I
6	M5047A	L3.5X3.5X5/16	28.447	L3.5x3.5x5/16					
7	M5226B	L3.5X3.5X5/16	28.447	L3.5x3.5x5/16					
8	M8628	L3.5X3.5X5/16	28.447	L3.5x3.5x5/16	2.02	7.2	28.4	205	I
9	M5036A	L3.5X3.5X5/16	28.447	L3.5x3.5x5/16					
10	M8627	L3.5X3.5X5/16	14.367	L3.5x3.5x5/16	2.02	7.2	14.4	103	I
	Subtotal						85.6	616.0	
1	M7663	L4X4X5/16	28.899	L4x4x5/16	2.4	8.2	28.9	237	I
2	M6512	L4X4X5/16	14.303	L4x4x5/16	2.4	8.2	14.3	117	I
3	M8097	L4X4X5/16	17.309	L4x4x5/16	2.4	8.2	17.3	142	I
4	M5060B	L4X4X5/16	28.899	L4x4x5/16	2.4	8.2	28.9	237	I
5	M8073	L4X4X5/16	17.309	L4x4x5/16	2.4	8.2	17.3	142	I
6	M4939B	L4X4X5/16	17.309	L4x4x5/16	2.4	8.2	17.3	142	I
7	M8674	L4X4X5/16	16.401	L4x4x5/16	2.4	8.2	16.4	134	I
8	M8111	L4X4X5/16	17.309	L4x4x5/16	2.4	8.2	17.3	142	I
9	M7619	L4X4X5/16	28.899	L4x4x5/16	2.4	8.2	28.9	237	I
10	M5246B	L4X4X5/16	16.401	L4x4x5/16	2.4	8.2	16.4	134	I
11	M8087	L4X4X5/16	17.309	L4x4x5/16	2.4	8.2	17.3	142	I
12	M5038A	L4X4X5/16	28.899	L4x4x5/16	2.4	8.2	28.9	237	I
13	M7663	L4X4X5/16	28.899	L4x4x5/16	2.4	8.2	28.9	237	I
14	M6512	L4X4X5/16	14.303	L4x4x5/16	2.4	8.2	14.3	117	I
15	M8097	L4X4X5/16	17.309	L4x4x5/16	2.4	8.2	17.3	142	I
16	M5060B	L4X4X5/16	28.899	L4x4x5/16	2.4	8.2	28.9	237	I
17	M8073	L4X4X5/16	17.309	L4x4x5/16	2.4	8.2	17.3	142	I
18	M4939B	L4X4X5/16	17.309	L4x4x5/16	2.4	8.2	17.3	142	I
19	M8674	L4X4X5/16	16.401	L4x4x5/16	2.4	8.2	16.4	134	I
20	M8111	L4X4X5/16	17.309	L4x4x5/16	2.4	8.2	17.3	142	I

HANGAR 1
Retrofit Quantity Estimate

Existing Member				New Member					
	Member ID	Shape	Length	Shape	Area	Unit length Weight (plf)	Length	Weight of Member (lb)	Type
21	M7619	L4X4X5/16	28.899	L4x4x5/16	2.4	8.2	28.9	237	I
22	M5246B	L4X4X5/16	16.401	L4x4x5/16	2.4	8.2	16.4	134	I
23	M8087	L4X4X5/16	17.309	L4x4x5/16	2.4	8.2	17.3	142	I
24	M5038A	L4X4X5/16	28.899	L4x4x5/16	2.4	8.2	28.9	237	I
	Subtotal						498.5	4086.0	
1	M5080B	L5X3.5X3/8	38.199	LL3.3x3.5x5/16					
2	M5080B	L5X3.5X3/8	38.199	LL3.3x3.5x5/16					
	Subtotal						0.0	0.0	
TOTAL:								Pounds	Tonnage
								17854	8.9

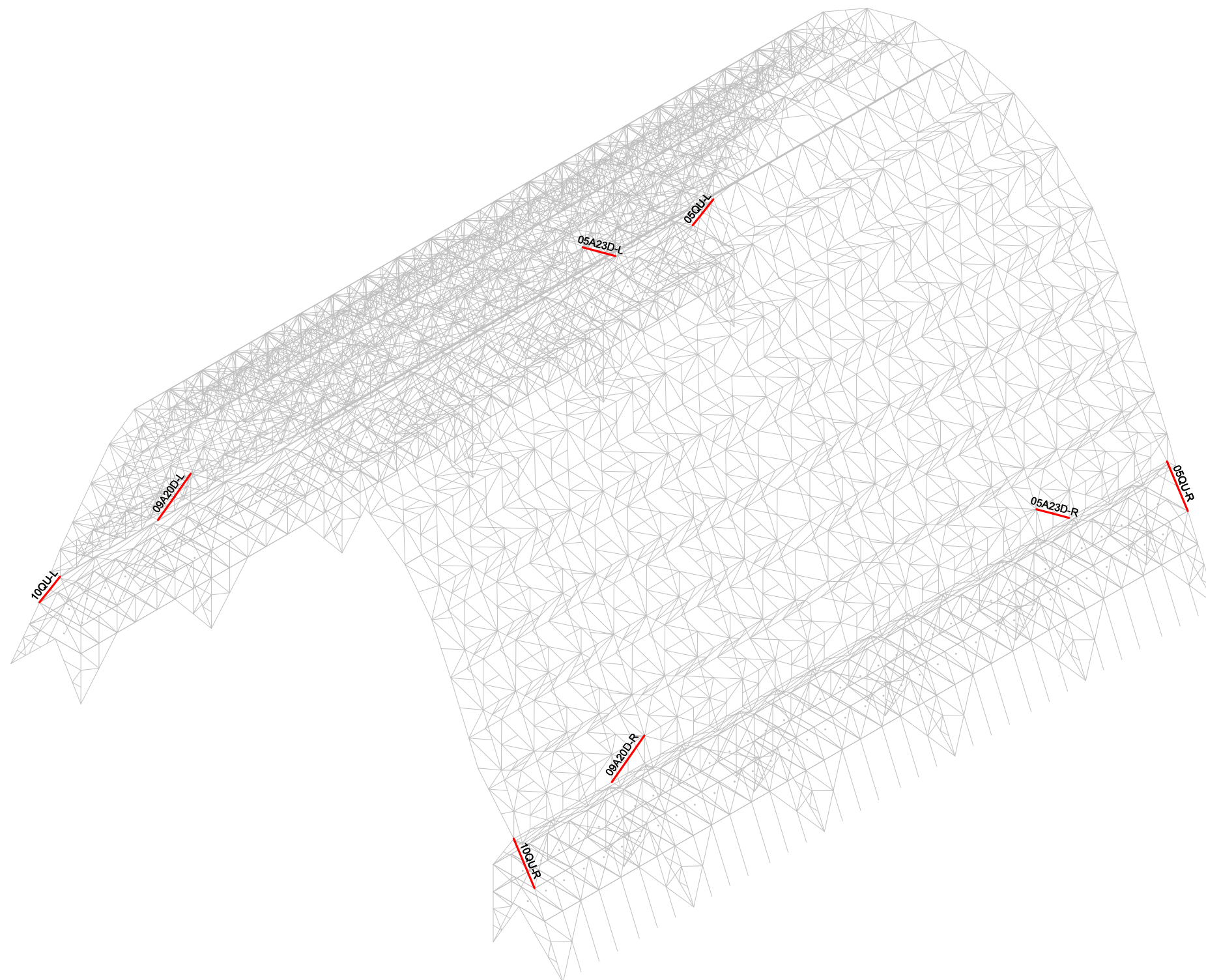
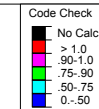

Solution: Envelope

ExelTech
AJC
1123

Middle Section
Middle Section Arches and Above A-Frame Seismic Envelope Label

SK - 2
Nov 2, 2011 at 11:56 AM
Hangar Middle_Section Above A-Frame 20111028.r3d



Code Check	
Black	No Calc
Red	> 1.0
Yellow	.90-1.0
Green	.75-.90
Cyan	.50-.75
Blue	0-.50

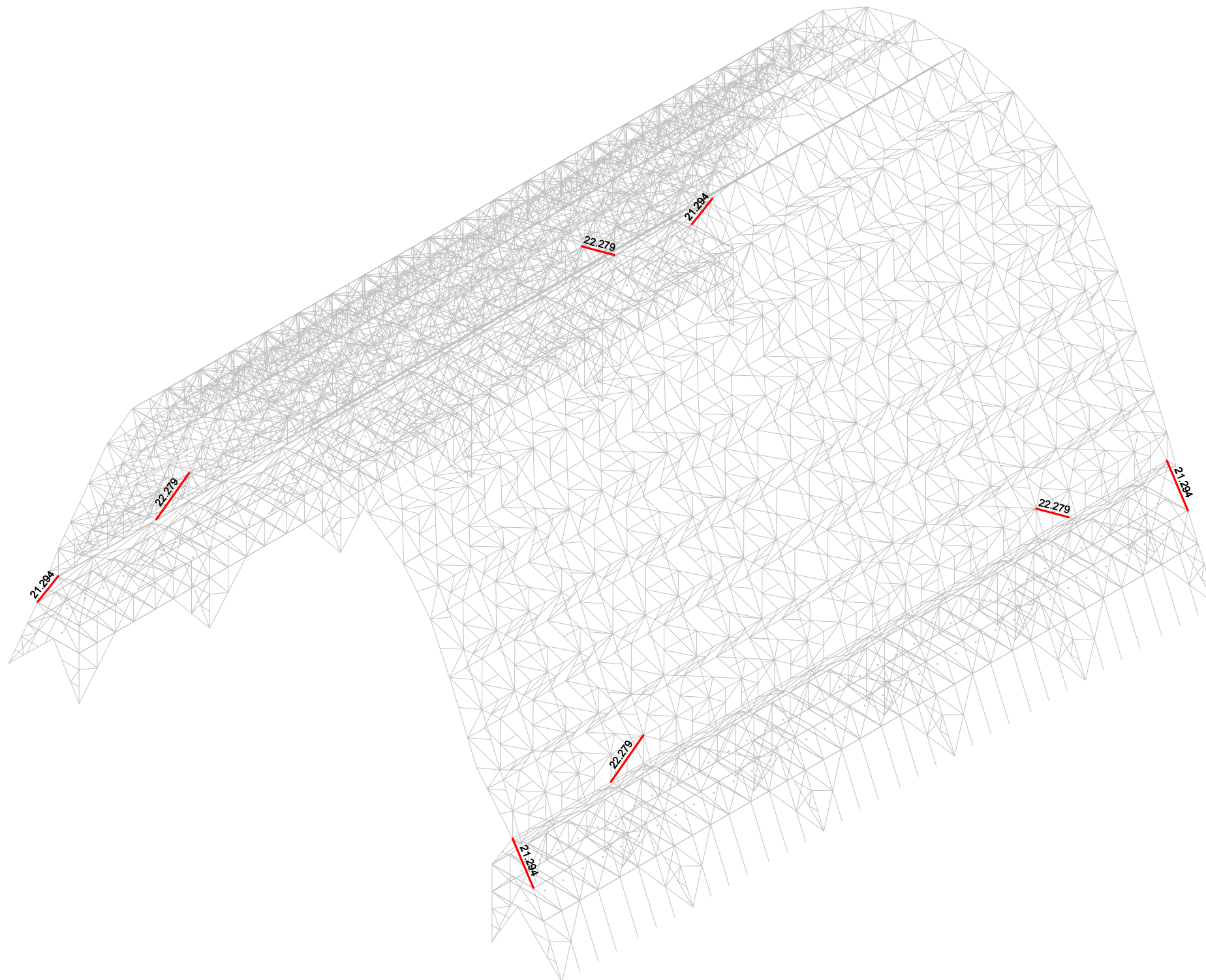

Member Length (ft) Displayed
Solution: Envelope

ExelTech	Middle Section Middle Section Arches and Above A-Frame Seismic Envelope Length	SK - 4
AJC		Nov 2, 2011 at 11:58 AM
1123		Hangar Middle_Section Above A-Frame 20111028.r3d



Code Check	
Black	No Calc
Red	> 1.0
Green	.90-1.0
Cyan	.75-.90
Blue	0-.75

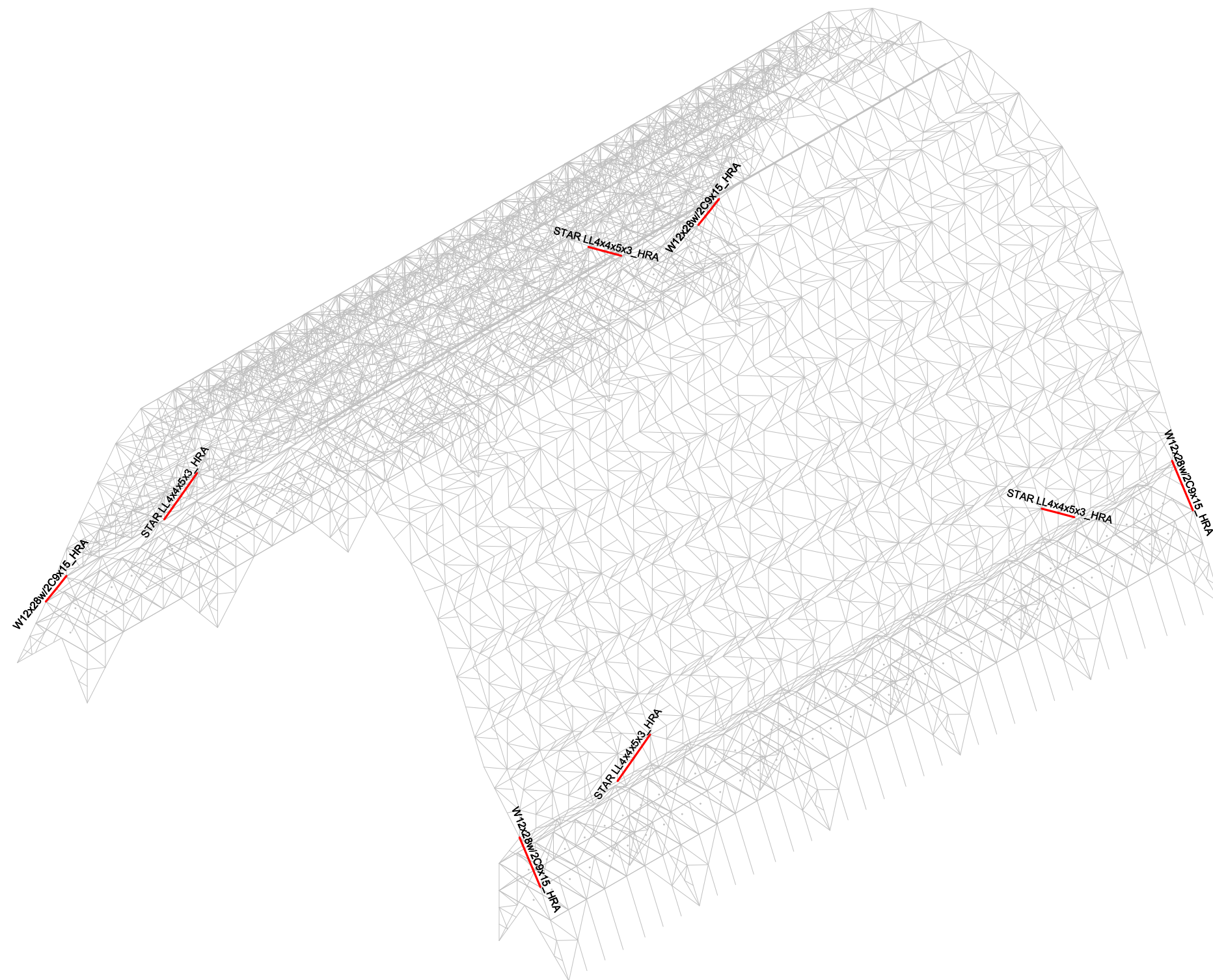

Solution: Envelope

ExelTech
AJC
1123

Middle Section
Middle Section Arches and Above A-Frame Seismic Envelope Shape

SK - 3
Nov 2, 2011 at 11:57 AM
Hangar Middle_Section Above A-Frame 20111028.r3d



Code Check	
Black	No Calc
Red	> 1.0
Green	.90-1.0
Cyan	.75-.90
Blue	.50-.75
Light Blue	0-.50

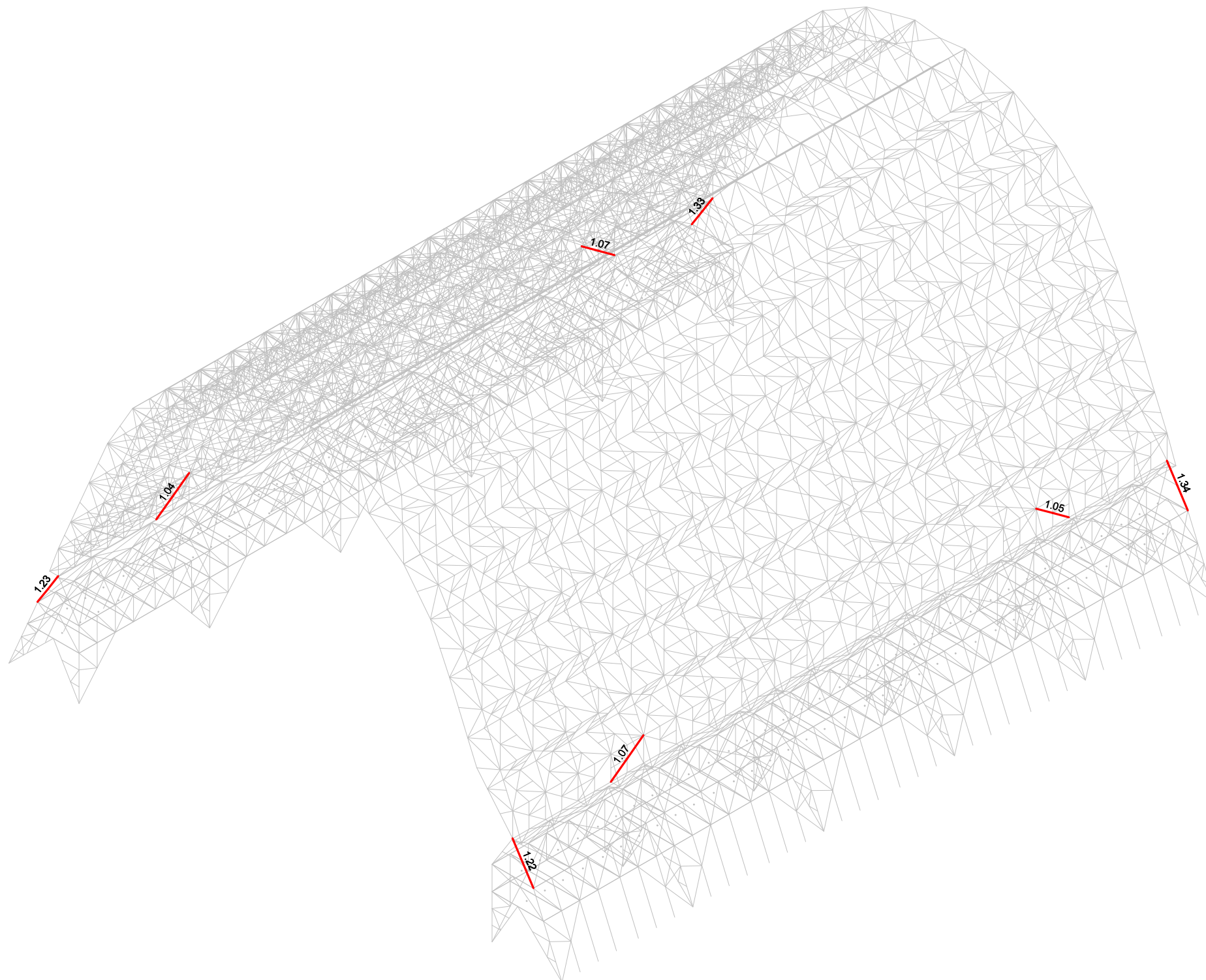

Member Code Checks Displayed
Solution: Envelope

ExelTech	Middle Section Middle Section Arches and Above A-Frame Seismic Envelope Unity	SK - 1
AJC		Nov 2, 2011 at 11:54 AM
1123		Hangar Middle_Section Above A-Frame 20111028.r3d

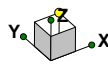

Code Check	
Black	No Calc
Red	>1.0
Magenta	.90-1.0
Green	.75-.90
Cyan	.50-.75
Blue	0-.50

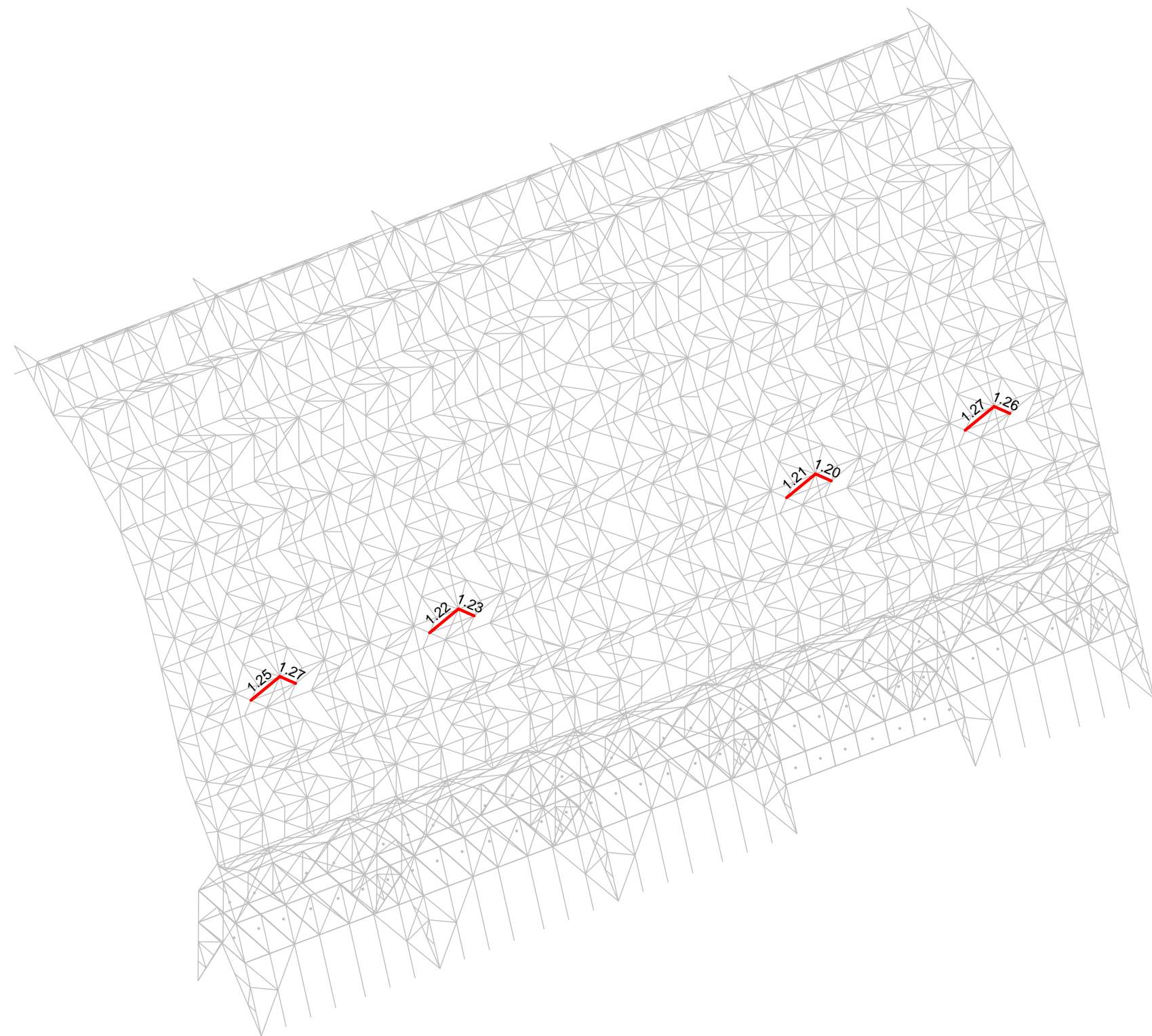

Member Code Checks Displayed
Solution: Envelope

ExelTech	Hangar 1 - Middle Section (Original) Iso Middle Wind Category II - Arches & Above A-Frame - Member_Unity	SK - 5
AJC		Oct 7, 2011 at 12:15 AM
1123		Hangar Middle_Site Class D_Original_Reduced Load 20110930_RISA.r3d

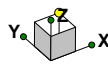

Code Check	
Black	No Calc
Red	>1.0
Yellow	.90-1.0
Green	.75-.90
Cyan	.50-.75
Blue	0-.50

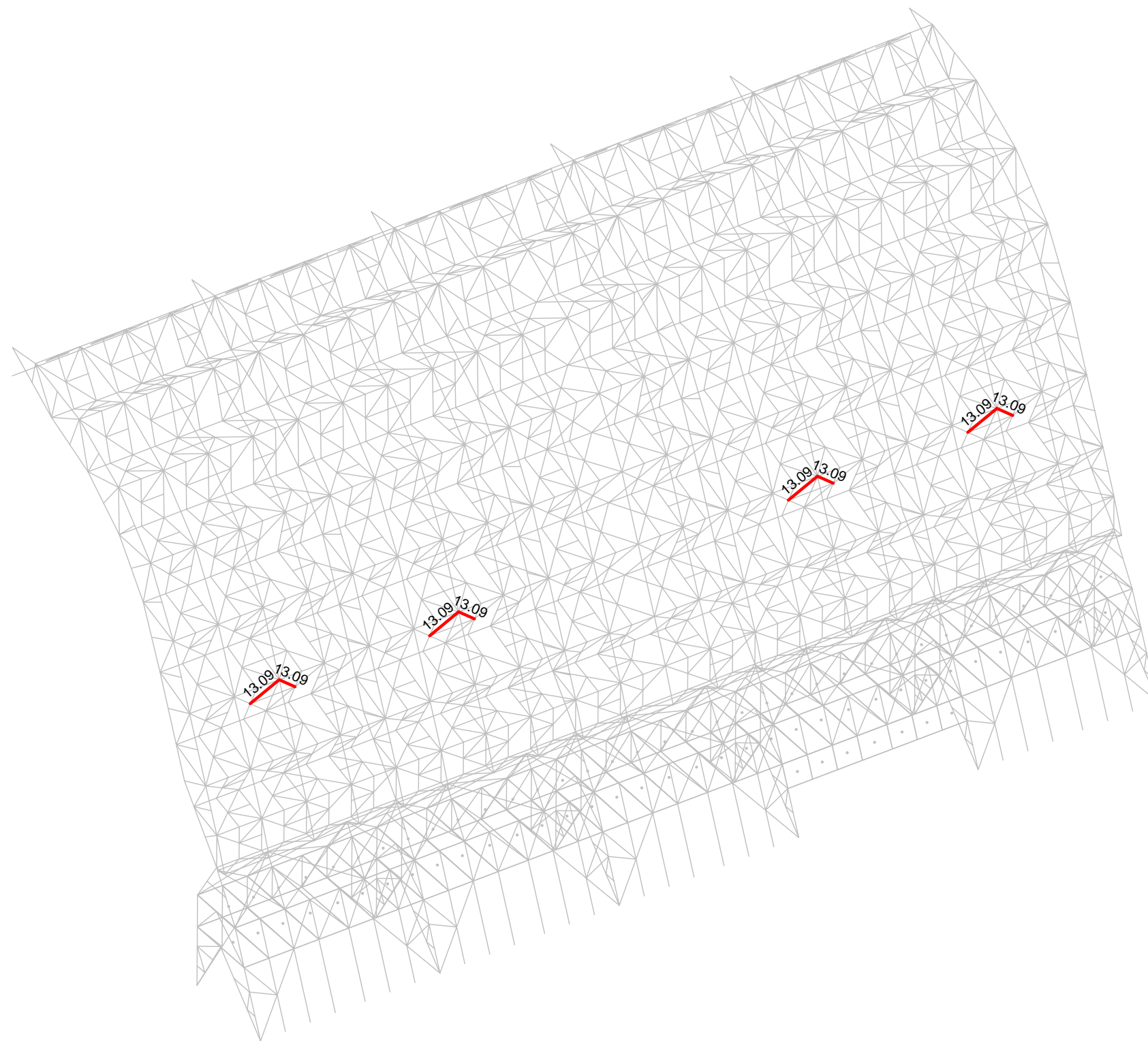

Member Length (ft) Displayed
Solution: Envelope

ExelTech	Hangar 1 - Middle Section (Original) Iso Middle Wind Catagory II - Member_Unity	SK - 8
AJC		Oct 6, 2011 at 8:35 AM
1123		Hangar Middle_Site Class D_Original_Reduced Load 20110930_RISA.r3d

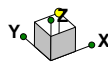

Code Check	
Black	No Calc
Red	>1.0
Magenta	.90-1.0
Green	.75-.90
Cyan	.50-.75
Blue	0-.50

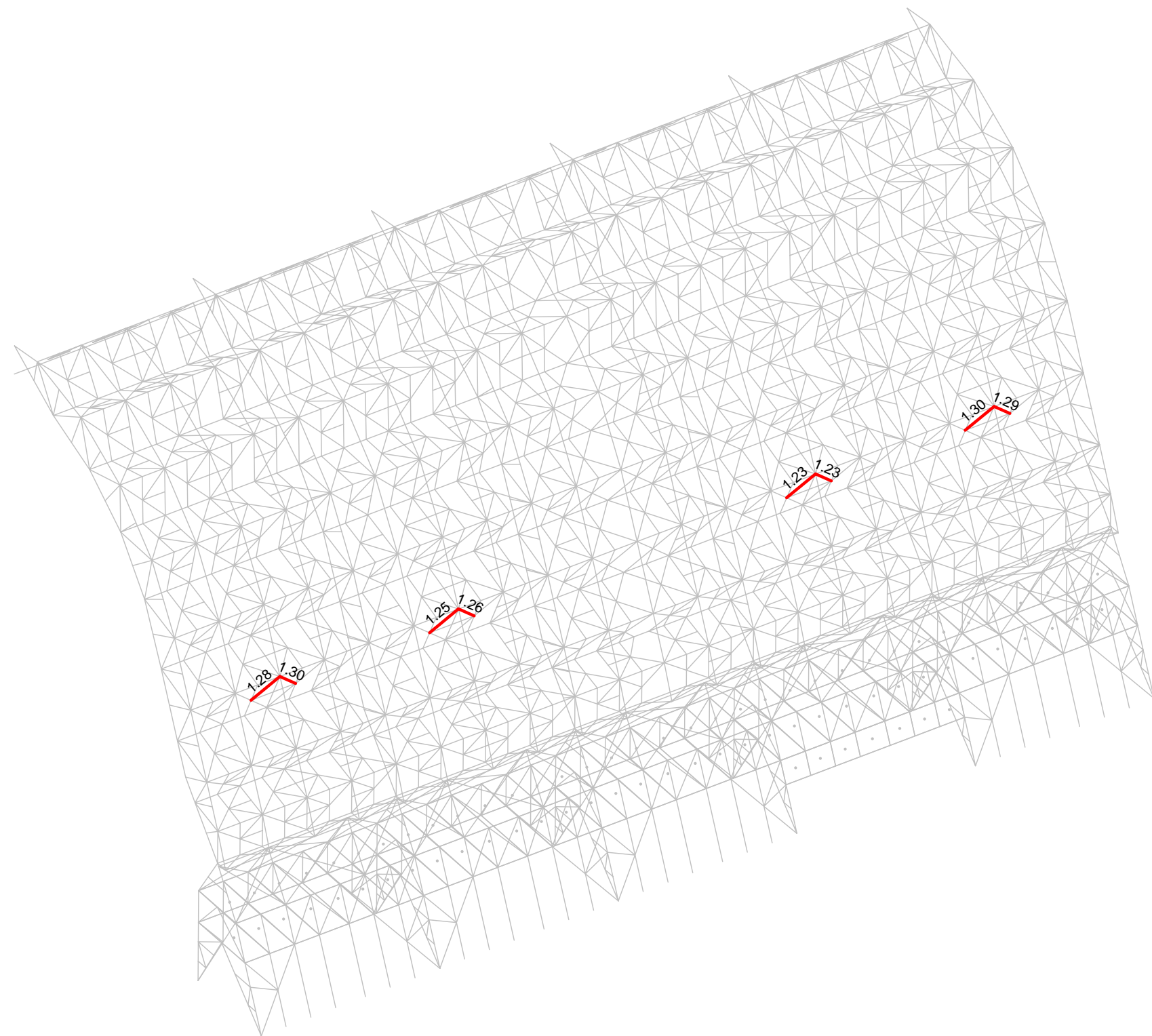

Member Code Checks Displayed
Solution: Envelope

ExelTech	Hangar 1 - Middle Section (Original) Iso Middle Wind Category III - Arches & Above A-Frame - Member_Unity	SK - 2
AJC		Oct 7, 2011 at 12:06 AM
1123		Hangar Middle_Site Class D_Original_Reduced Load 20110930_RISA.r3d



Code Check
No Calc
> 1.0
.90-1.0
.75-.90
.50-.75
0-.50



Member Code Checks Displayed
Solution: Envelope

ExelTech
AJC
1123

Middle Section
Middle Section Arches Only Seismic Envelope Unity

SK - 5
Nov 2, 2011 at 12:03 PM
Hangar Middle_Section Above A-Frame 20111028.r3d

Table B (Middle Section)

Members Above A-Frame under Seismic Loads

	Existing Member				New Member					
	Member ID	Shape	Unity	Length	Shape	Area	Unit length Weight (plf)	Length (ft)	Weight of Member (lb)	Type
1	09A20D-R	STAR LL4x4x5/16	1.068	22.28	LL3x3x5/16	3.55	12.1	22.3	270	TYPE IVb
2	05A23D-L	STAR LL4x4x5/16	1.067	22.28	LL3x3x5/16	3.55	12.1	22.3	270	TYPE IVb
3	05A23D-R	STAR LL4x4x5/16	1.049	22.28	LL3x3x5/16	3.55	12.1	22.3	270	TYPE IVb
4	09A20D-L	STAR LL4x4x5/16	1.041	22.28	LL3x3x5/16	3.55	12.1	22.3	270	TYPE IVb
	Subtotal					14.2		89	1080	
1	05QU-R	W12x28w/2C9x15	1.335	20.43	2C10x30	17.64	60.03	20.4	1227	TYPE V
2	05QU-L	W12x28w/2C9x15	1.33	20.43	2C10x30	17.64	60.03	20.4	1227	TYPE V
3	10QU-L	W12x28w/2C9x15	1.228	20.43	2C10x30	17.64	60.03	20.4	1227	TYPE V
4	10QU-R	W12x28w/2C9x15	1.217	20.43	2C10x30	17.64	60.03	20.4	1227	TYPE V
	Subtotal							82	4908	
TOTAL:									Pounds	Tonnage
									5988	3.0

HANGAR 1

Retrofi Quantity Estimate Summary

Table ID	Location	Retrofitted Member	Added Member	Total Length ft	Subtotal wt (lbs)	Total Weight ibs
Table A	End Section (North and South)	LL3.5x3.5x5/16x3/8	L3.5x3.5x5/16	511	3676	7352
		LL4x4x5/16x3/8	L4x4x5/16	498	7172	14344
		LL5x3.5x3/8X3/8	L5x3.5x3/8	458	4676	9352
		STAR LL3.5X2.5X516 +LL3x3x5/16	LL3x3x5/16/3/8	211	2550.0	5100
		STAR LL4x4x5/16 +LL3x3x5/16	LL3x3x5/16/3/8	111	1350.0	2700
Table B	Middle Section	STAR LL4x4x5/16 +LL3x3x5/16	LL3x3x5/16/3/8	89		1080
		W12x28w/2C9x15 +2C10x30	2C10x30	82		4908
Total Material for the members					(lbs)	44836
Allow 2% for Misc Connection s etc						897
					Tons	22.87

Notes:

*The material length and weight for Table A has been doubled with consideration of both South and North Sites.
The graphics of structures under wind load are for wind load from one direction. increased with consideration of
Actual numbers of overstressed members have been wind load from both directions*

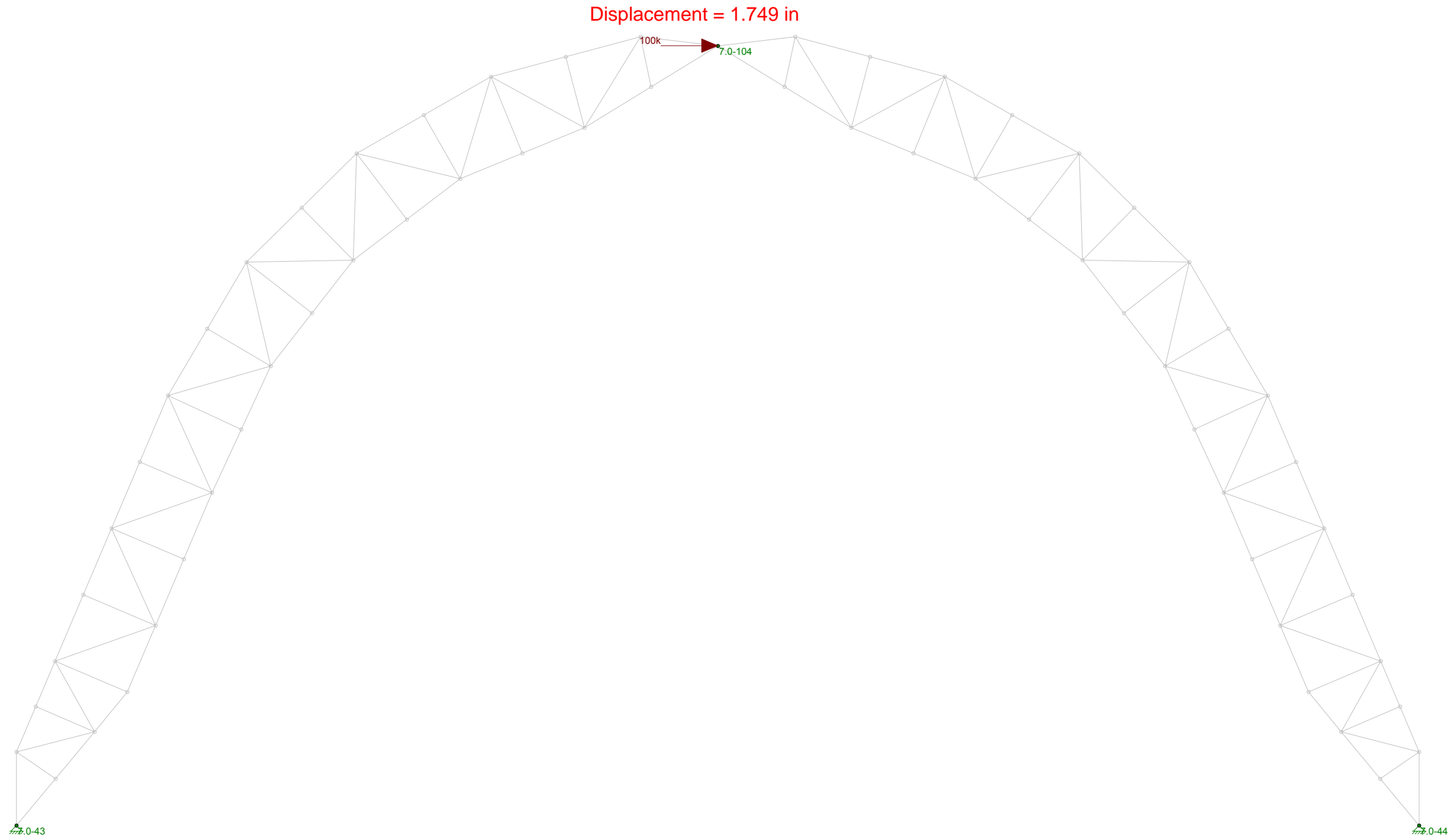

Loads: BLC 31, Dummy
Results for LC 28, Displacement

ExelTech
AjC
1123

Hangar 1 - Middle Section (Original)
Middle Section Top Arch Displacement Check

SK - 1
Nov 2, 2011 at 10:15 AM
Hangar Middle_Site Class D_singl arch Top.r3d



Loads: BLC 32, Dummy
Results for LC 27,

ExelTech
AjC
1123

Hangar 1 - Middle Section (Original)
Middle Section A-Frame Displacement Check

SK - 1
Nov 2, 2011 at 10:21 AM
Hangar Middle_Site Class D_singl arch A-Frame.r3d



Potential Site 3 (PS3)
Hangar1 Subsurface

Hangar 1

PS3-1 (µg/L)	
Depth:	20'
PCE	ND
TCE	300
cis-1,2-DCE	190
trans-1,2-DCE	2.6
1,1-DCE	12
Vinyl Chloride	1.8
1,1,1-TCA	1.7
1,1-DCA	7.4
Freon 113	6.0

PS3-2 (µg/L)	
Depth:	25'
PCE	ND
TCE	480
cis-1,2-DCE	130
trans-1,2-DCE	3.7
1,1-DCE	22
Vinyl Chloride	1.1
1,1,1-TCA	3.3
1,1-DCA	12
Freon 113	14

PS3-3 (µg/L)	
Depth:	20'
PCE	ND
TCE	250
cis-1,2-DCE	160
trans-1,2-DCE	1.1
1,1-DCE	11
vinyl chloride	2.0
1,1,1-TCA	1.4
1,1-DCA	6.8
Freon 113	4.7

PS3-4 (µg/L)	
Depth:	14'
PCE	ND
TCE	1.6
cis-1,2-DCE	0.56
trans-1,2-DCE	ND
1,1-DCE	ND
Vinyl Chloride	ND
1,1,1-TCA	ND
1,1-DCA	ND
Freon 113	ND

PS3-5 (µg/L)			
Depth:	20'	40'	56'
PCE	2.1	7800	0.56
TCE	260	630	0.80
cis-1,2-DCE	240	110	0.60
trans-1,2-DCE	1.2	1.2	ND
1,1-DCE	13	18	ND
vinyl chloride	4.3	1.2	ND
1,1,1-TCA	0.91	ND	ND
1,1-DCA	6.9	7.6	ND
Freon 113	5.0	14	ND

PS3-6 (µg/L)			
Depth:	13'	23'	40'
PCE	ND	ND	16
TCE	250	320	340
cis-1,2-DCE	99	91	100
trans-1,2-DCE	6.9	1.7	1.9
1,1-DCE	5.9	9.7	15
Vinyl Chloride	ND	0.92	0.67
1,1,1-TCA	1.1	1.9	0.74
1,1-DCA	7.2	5.9	7.1
Freon 113	1.7	5.0	6.8

LEGEND	
PCE	Tetrachloroethene
TCE	Trichloroethene
cis-1,2-DCE	cis-1,2-Dicchloroethene
trans-1,2-DCE	trans-1,2-Dicchloroethene
1,1-DCE	1,1-Dicchloroethene
1,1,1-TCA	1,1,1-Trichloroethane
1,1-DCA	1,1-Dichloroethane
ND	Not Detected > Reporting Limit
Bold	Concentration < ESL
Bold	Concentration > ESL
ESL	Environmental Screening Level

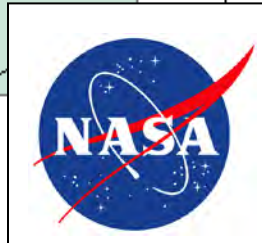

PLATE X
Groundwater sampling results for Potential Site 3, Hangar 1 subsurface.



**Potential Site 3 (PS3)
Hangar 1 Subsurface**

PS3-1 (mg/kg)		
Depth:	6'	8'
TPH-MO	ND	ND
TPH-D	ND	ND
TCE	0.010	0.0055
cis-1,2-DCE	ND	ND

PS3-2 (mg/kg)	
Depth:	4'
TPH-MO	ND
TPH-D	ND
TCE	0.0055
cis-1,2-DCE	ND

PS3-3 (mg/kg)			
Depth:	0'	6'	8'
TPH-MO	ND	ND	ND
TPH-D	ND	ND	ND
TCE	0.0065	0.026	0.0077
cis-1,2-DCE	ND	ND	ND

PS3-4 (mg/kg)			
Depth:	2'	6'	8'
TPH-MO	ND	ND	ND
TPH-D	ND	ND	ND
TCE	0.0061	0.0092	0.019
cis-1,2-DCE	ND	ND	ND

PS3-5 (mg/kg)		
Depth:	2'	6'
TPH-MO	ND	ND
TPH-D	ND	ND
TCE	0.0065	0.029
cis-1,2-DCE	ND	0.0066

PS3-6 (mg/kg)			
Depth:	0'	6'	8'
TPH-MO	24	ND	ND
TPH-D	6.4	ND	ND
TCE	ND	0.035	0.110
cis-1,2-DCE	ND	ND	ND

LEGEND	
TPH-MO	Motor Oil Range Hydrocarbon
TPH-D	Diesel Range Hydrocarbon
TCE	Trichloroethene
cis-1,2-DCE	cis-1,2-Dichloroethene
ND	Not Detected > Reporting Limit
Green	Concentration < ESL
Red	Concentration > ESL
ESL	Environmental Screening Level

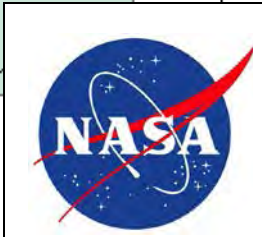

PLATE X
Soil sampling results for Potential Site 3, Hangar One subsurface.

Appendix N: Potential Materials and Providers

Note: Refer also to Appenix I Hangar One Architectural Façade Sturdy for additional material research and references

Metal Wall Panels- Preferred Vendors & Products

AEP-SPAN

Contact: Kim Kishi 916.765.4282
kkishi@aepspan.com

Custom Metal Panels to match both the V-Beam Siding and Mansard Siding Profiles

Off the shelf profiles:

Mini V-Beam profile
20 gage
1-3/8" deep x 4-9/16" rib to rib
3.32-3.82 per square foot

HR-36 Profile
20 gage
1-1/2" deep x 7-3/16" rib to rib
3.32-3.82 per square foot

Nu-Wave Profile
20 gage
7/8" deep x 2-2/3" rib to rib
3.32-3.82 per square foot

METL-SPAN

Contact: Kim Kishi 916.765.4282
kkishi@aepspan.com

2" Insulated core metal sandwich panels for use to replace existing redwood decking

Metal Wall Panels- Additional, Acceptable Vendors

Centria

Contact: Gary Smith 650.369.9400
gsmith@centria.com

Fabral

Contact: Michael Bright 707.224.6877
mbright@brightgroup.us

Corrugated Metals, Inc.

Contact: Anna Tavlas 815.323.1320
a.tavlas@corrugated-metlas.com

Joe Sheil 800.621.5617
j.sheil@corrugated-metals.com

A.C. Dellovade (Panel Installer)

Contact: Gary Dellovade 724.873.8190
gary.dellovade@acdellovade.com

Windows- Preferred Vendors & Products

TGP Technical Glass Products

Contact: Devon Bowman 425.396.8211
devinb@fireglass.com

Custom corrugated, wired windows (Japanese Source brokered by an American Company) to match existing profile, frame and detailing

Japanese Source is NSG Group, Wire Wavelight

Flat wired windows to match existing frame and detailing

Windows- Additional, Acceptable Vendors

Stiles Custom Metal, Inc.

Contact: Rob Westphal 209.604.1414
robwestphal@sbcglobal.net

Ventana Doors & Windows

Contact: Daniel Aleksander 805.966.3233
Daniel@ventanadoor.com



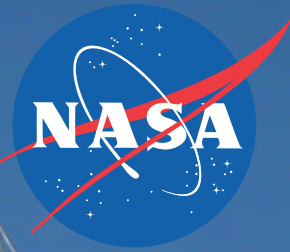

Condition Assessment and Rehabilitation Plan Hangar One

for NASA Headquarters and
Ames Research Center, California

Volume 4
Cost Estimate



NASA Ames Research Center

Hangar One – Moffett Field Rehabilitation Project Installation of Siding, Roof and Windows

Moffett Field, California

BASIS OF ESTIMATE



Estimate ID: 2011.421240
Project Name: Moffett Field Hangar One
Class Estimate: Class 4
Requested By: Jerry Morgan/PDX
Estimated By: Rob Edgerton/PDX
Estimator Phone: 503.872.4590
Estimate Date: September 23, 2011
Estimate Revision: November 30, 2011

ESTIMATOR

Purpose of Estimate

The purpose of this Engineer’s Estimate for Construction Cost is to establish an Engineer’s opinion of probable cost at 10% design.

General Project Description

NASA Ames Research Center is planning for the rehabilitation of Hangar One, a historic property located at Moffett Field, California. The hangar is currently undergoing removal action to remove hazardous materials. The removal action is being undertaken by the US Navy, as a Navy responsibility. At the conclusion of the Navy’s effort, the hangar will be returned to NASA as a structure without the exterior siding, roof and windows. NASA’s desire is to rehabilitate the hangar with new metal siding, new windows, install a new roof on the upper crown of the hangar and return the hangar to a state of usefulness. This estimate presents options to assist NASA with the knowledge of costs of materials available on the market and available for the rehabilitation work.

Overall Costs

The following is a summary breakdown of the costs.

See attached breakdown for additional detailed information.

Low Range	ESTIMATED COST	High Range
	Option A: Basic Re-Skinning, Maintain Existing Hangar Use	
-20%		30%
\$32,580,000	\$40,719,000	\$52,930,000
	Option B: Re-Skinning with Upgrades (Geotechnical, Structural and Slab) and Re-Use as a Hangar to meet California Historic Building Code	
-20%		30%
\$36,320,000	\$45,394,000	\$59,010,000
	Option C: Re-Skinning with Upgrades (Geotechnical, Structural and Slab) and Re-Use as a Hangar to meet California Historic Building Code with Historic Consideration	
-20%		30%
\$36,290,000	\$45,386,000	\$58,980,000
	Option D: Adaptive Re-Use, Re-Skinning with Upgrades (Geotechnical, Structural and Slab) and Re-Use as a Higher Occupancy Level (Assembly, or Mixed Use)	
-20%		30%
\$36,210,000	\$45,264,000	\$58,840,000
	Option E1: Layaway Plan after Re-Skinning (Annual Cost 2011 \$)	
-20%		30%
\$250,000	\$310,000	\$400,000

Low Range	ESTIMATED COST	High Range
	Option E2: Layaway Plan without Re-Skinning (Annual Cost 2011 \$)	
-20%		30%
\$210,000	\$265,000	\$340,000
	Option F: Building Demolition	
-20%		30%
\$35,510,000	\$44,392,000	\$57,710,000

SUBSTITUTION OPTIONS

These costs should be added or subtracted from the project cost as noted below for each option. All options are independent in their application and evaluation.

Low Range	ESTIMATED SUBSTITUTION COST	High Range
	Substitution 1 - Redwood Roof Deck	
-20%		30%
\$2,640,000	\$3,300,000	\$4,290,000
	Substitution 2 - Panelized Roof Deck Installation	
-20%		30%
(\$720,000)	(\$904,000)	(\$1,180,000)
	Substitution 3 - U.S. Corrugated Glass	
-20%		30%
\$2,480,000	\$3,099,000	\$4,030,000
	Substitution 4 - Flat Glass in Lieu of Corrugated Glass	
-20%		30%
(\$8,250,000)	(\$10,317,000)	(\$13,410,000)
	Substitution 5 - Corrugated Fiberglass in Lieu of Corrugated Glass	
-20%		30%
(\$9,620,000)	(\$12,026,000)	(\$15,630,000)
	Substitution 6 - Translucent Panels for Window Openings	
-20%		30%
(\$9,080,000)	(\$11,353,000)	(\$14,760,000)
	Substitution 7 - Custom Panel Profiles	
-20%		30%
\$160,000	\$196,000	\$250,000
	Substitution 8a - 30% Concrete Slab Removal	
-20%		30%
\$3,750,000	\$4,688,000	\$6,090,000
	Substitution 8b - 60% Concrete Slab Removal	
-20%		30%
\$7,180,000	\$8,972,000	\$11,660,000
	Substitution 8c - 100% Concrete Slab Removal	
-20%		30%
\$11,930,000	\$14,913,000	\$19,390,000
	Substitution 9 -Thin Film PV Install	
-20%		30%
\$20,780,000	\$25,980,000	\$33,770,000

	Substitution 10 -Standard Profile Metal Panels	
-20%		30%
(\$610,000)	(\$762,000)	(\$990,000)
	Substitution 11 - 1.98 mils Zinc Coat Metal Panels	
-20%		30%
\$2,440,000	\$3,048,000	\$3,960,000
	Substitution 12 - 3.24 mils Zinc Coat Metal Panels	
-20%		30%
\$3,660,000	\$4,572,000	\$5,940,000
	Substitution 13 - Infrared Heat Strips at Roof Crown	
-20%		30%
\$1,130,000	\$1,407,000	\$1,830,000

Scope of Work

The following Options descriptions are provided as a general summary and basis for the estimate that follows. For detailed description and discussion of these options refer to Volume II of the Condition Assessment and Rehabilitation Plan.

Option A – Basic Re-Skinning, Maintain Existing Hangar Use

Install a new exterior skin system on the structure. Occupancy of the building will be unchanged and will be re-used as an aircraft hangar. Included is a full structural assessment of the existing hangar structure per Executive Order 12491 and the California Historical Building Code. This includes a plan to remedy only those deficiencies determined as posing immediate hazardous conditions. Because the occupancy of the building has not changed from its original use, the CHBC does not require structural upgrades as the hangar continues to be utilized as it was originally designed for. This analysis, therefore, does not include existing risks from potential seismic forces. Full geotechnical ground improvements and structural upgrades to meet Executive Order 12491 and the current California Historical Building Code are not included. Option A, therefore, has additional risks compared to Option B because it does not address the possible seismic risks identified in the geotechnical analysis portion of this report, although, the risks are the same as they have been since the hangar's original construction. Option A also includes provisions for basic, code minimum building system services based on maintaining the existing hangar occupancy. Final Design solutions to exercise this option must include a plan to address Historic Preservation issues with the State Historic Preservation Officer (SHPO) associated with re-skinning the hangar.

Option B – Re-Skinning with Upgrades (Geotechnical, Structural and Slab) and Re-Use as a Hangar to meet California Historic Building Code

Option B also includes reuse of the building as an aircraft hangar. In addition to the exterior skin replacement of Option A, Option B further includes repairs of structural deficiencies identified in the condition assessment. In response to geotechnical findings and structural analysis of Hangar One structural system perform geotechnical ground improvements and structural upgrades in accordance with the California Historical Building Code and Executive Order 12941 for a hangar occupancy type. Any soil

remediation design and future geotechnical investigations need to take into account the contaminated groundwater at the site and must be approved by NASA to ensure that the contamination is not spread or migrated into areas that are currently not contaminated. The soil remediation and future geotechnical investigations must also not interfere with the Navy's remedial measures to clean up the ground water contamination. To accommodate current loading requirements, install a new concrete floor slab. Include basic, code minimum building system services based on maintaining the existing hangar occupancy.

In addition to replacing the external skin, Option B addresses structural deficiencies identified using current codes and analysis methods. Repairs under this plan, including soil improvements and structural strengthening, would bring this building up to a more useable, safer building for potential occupants.

Option C – Re-Skinning with Upgrades (Geotechnical, Structural and Slab) and Re-Use as a Hangar to meet California Historic Building Code with Historic Consideration

Include all improvements associated with Option B. Review and analysis of impacts to the historic resource shows that all improvements and structural upgrades associated with Option B can be done in a manner to not adversely impact historic status of Hangar One.

Option D – Adaptive Re-Use, Re-Skinning with Upgrades (Geotechnical, Structural and Slab) and Re-Use as a Higher Occupancy Level (Assembly, or Mixed Use)

Under Option D, occupancy of the building will be increased to assume potential alternatives for Assembly and Mixed Use occupancies. Because a change of occupancy requires that the building is brought up to current relevant codes, perform geotechnical ground improvements and structural upgrades to meet the current California Historic Building Code and in accordance with Executive Order 12941 for an assembly occupancy type. Install a new concrete floor slab. Include basic, code minimum building system services and egress system based on three levels of assumed occupancy.

Option E1 – Layaway Plan after Re-Skinning

Option E1 includes estimated costs for annual, cyclical maintenance for the re-skinned hangar.

Option E2 – Layaway Plan without Re-Skinning

Option E2 includes estimated costs for annual, cyclical maintenance for the un-skinned hangar.

Option F – Building Demolition

Option F includes estimated costs associated with demolition of the remediated structure, concrete foundations and concrete hangar floor slab.

The following Material Substitution descriptions are provided as a general summary and basis for the estimate that follows. For detailed description and discussion of these

material substitutions refer to Volume II of the Condition Assessment and Rehabilitation Plan.

Substitution 1 – Redwood Roof Deck

This item provides the incremental cost to use redwood roof decking in the same areas as it currently exists in lieu of the standard metal decking contained in the base estimate.

Substitution 2 – Panelized Roof Deck Installation

This item provides the incremental cost (deduction) to use panelized roof deck construction in lieu of the cost of individual sheet installation contained in the base estimate.

Substitution 3 – U.S. Corrugated Glass

This item provides the incremental cost to use United States manufacture corrugated glass in the same areas as it currently exists in lieu of the offshore manufactured glass contained in the base estimate.

Substitution 4 – Flat Glass in Lieu of Corrugated Glass

This item provides the incremental cost (deduction) to use flat glass in the windows where corrugated glass is shown in the base estimate. The cost savings is calculated against the assumption foreign manufactured glass would be used.

Substitution 5 – Corrugated Fiberglass in Lieu of Corrugated Glass

This item provides the incremental cost (deduction) to use corrugated fiberglass in the windows where corrugated glass is shown in the base estimate. The cost savings is calculated against the assumption foreign manufactured glass would be used.

Substitution 6 – Translucent Panels for Window Openings

This item provides the incremental cost (deduction) to use translucent panels (Kalwall) in all windows where corrugated glass and flat glass is shown in the base estimate. The cost savings is calculated against the assumption foreign manufactured corrugated glass would be used where that profile was specified.

Substitution 7 – Custom Panel Profiles

This item provides the incremental cost to use additional custom manufactured panels for the second profile building skin profile discovered during site visits. This is the anticipated cost to request the manufacturer to produce and use a custom set of rolls for material production. This same cost has been incorporated into the base estimate to cover the cost of producing custom profile panels for the upper section of the building and is provided here to show the credit involved in providing a single panel profile over the entire hangar.

Substitution 8a – 30% Concrete Slab Removal

This item provides the incremental cost to remove and replace up to 30% of the interior slab on grade for the building due to structural, or other identified needs. This cost does

not assume the sections are contiguous and specific areas are not identified, only the quantity to be replaced.

Substitution 8b – 60% Concrete Slab Removal

This item provides the incremental cost to remove and replace up to 60% of the interior slab on grade for the building due to structural, or other identified needs. This cost does not assume the sections are contiguous and specific areas are not identified, only the quantity to be replaced.

Substitution 8c – 100% Concrete Slab Removal

This item provides the incremental cost to remove and replace 100% of the interior slab on grade for the building due to structural, or other identified needs. This cost assumes the sections are contiguous and covers the specified quantity identified in the estimate.

Substitution 9 –Thin Film PV Install

This item provides the incremental cost to install 2,354,000 watts of photovoltaic cells manufactured using the thin film process on the building. The cost includes associated equipment necessary for monitoring and operation of the panels and conversion to necessary line voltage.

Substitution 10 –Standard Profile Metal Panels

This item provides the incremental cost (deduction) to install standard profile 20ga galvanized metal panels in lieu of custom profile manufactured panels.

Substitution 11 – 1.98 mils Zinc Coat Metal Panels

This item provides the incremental cost to provide the specified additional thickness of zinc coating on the metal panels in lieu of the industry standard.

Substitution 12 – 3.24 mils Zinc Coat Metal Panels

This item provides the incremental cost to provide the specified additional thickness of zinc coating on the metal panels in lieu of the industry standard.

Substitution 13 – Infrared Heat Strips at Roof Crown

This item provides the incremental cost to provide infrared heating strips in the roof crown area as a means to mitigate condensation formation that occurs under certain environmental conditions.

Markups

The following expected contractor markups were applied to the Cost Estimate:

Jobsite Safety & Security	1.500	%
Jobsite Overhead (GC's)	5.000	%
Overhead (GC Home Office)	2.000	%
Contractor Profit	5.000	%

Contractor Fee on Subs	4.000	%
Mob/Demob	10.000	%
Bonds & Insurance	From Table	
Design & Construction Contingency	20.000	%
Escalation	4.470	%
Market Adjustment Factor	-2.220	%
California Sales Tax	8.250	%
Design Build Fee	6.750	%
Engineering SDC	4.500	%

Escalation Rate

Escalation for this project is based on using information generated by CH2MHILL from subscription services such as IHS Global, Engineering News Record, Marshall & Swift, and other sources. Work is categorized into specific types of construction and expected factors applied. For this project it was assumed that Notice to Proceed would occur between April and August 2012, with construction complete by January 2014.

Additional escalation factors for six outlying years are presented in Appendix C.

Market Conditions

The current market conditions are drastically affecting the construction market, across the country. This is based upon recent bids and comparisons with Engineer's Estimates. Bids are being very erratic with some jobs having a normal number of bidders, and others receiving 20 to 30 submittals. Despite the estimator's best practices and adjustments, bids are being driven by current market conditions.

The market adjustment factor is beyond the typical contractor mark-ups, normal estimating contingency and current but normal escalation factors listed previously.

The Market Adjustment covers:

- Contractor work volume
- Contractors experience with the owner
- Owner requirements and contracting methodology
- Availability of management staff.
- Availability of crafts/trades.
- Volatile raw material markets.
- Fuel cost uncertainty - Oil = \$85 barrel, Gas \$4.00/Gal.
- Availability of bonds & insurance.
- Construction lending rates to commercial clients (contractors).

Estimate Classification

This cost estimate prepared is considered a Schematic or Class 4 estimate as defined by the Association for Advancement of Cost Engineering International (AACEI). It is considered accurate to +30% to -20%, based upon a 10% design deliverable.

The cost estimates shown have been prepared for guidance in project evaluation and implementation from the information available at the time of the estimate. The final cost of the project will depend upon the actual labor and material costs, competitive market conditions, final project costs, implementation schedule and other variable factors. As a result, the final project costs will vary from the estimates presented herein. Because of this, project feasibility and funding needs must be carefully reviewed prior to making specific financial decisions to help ensure proper project evaluation and adequate funding. Our estimate is based on material, equipment, and labor pricing as of 09/26/2011 (CA100029 09/09/2011 CA29). The client should be cautioned that material prices are volatile as a result of current market conditions.

Cost Resources

The following is a list of the various cost resources used in the development of the cost estimate.

- R.S. Means
- Richardson Process Plant Estimating Standards
- Mechanical Contractors Association - Labor Manual
- National Electrical Contractors Association - Labor Manual
- Marshall & Swift Valuation Service
- CH2M HILL Historical Data
- IHS Global Insight
- Vendor Quotes on Equipment and Materials where available.
- Estimator Judgment

Labor unit prices reflect a burdened rate, including: workers compensation, unemployment taxes, fringe benefits, and medical insurance.

Estimate Methodology

This cost estimate is considered a bottom rolled up type estimate with detailed cost items and breakdown of labor, materials and equipment. Some quotations were obtained for various items. The estimate may include allowance cost and dollars per SF cost for certain components of the estimate.

Labor Costs

The estimate has been adjusted for local area labor rates, based upon CA100029 09/09/2011 CA29.

Sales Tax

The estimate has been adjusted for local area material sales tax of 8.25%.

Allowance Costs

The cost estimate includes the following allowances within the cost estimate:

- The cost of general conditions was estimated at 5% of total cost.
- General contractor home office expense is estimated at 2% of total cost.
- Safety and Security was estimated at 1.5%.

Major Assumptions

The estimate is based on the assumption the work will be done on a competitive bid basis and the contractor will have a reasonable amount of time to complete the work. All contractors are equal, with a reasonable project schedule, no overtime, constructed as under a single contract, no liquidated damages.

This estimate should be evaluated for market changes after 90 days of the issue date.

- Overhead power and communication cables will be decommissioned and/or moved out of the work envelope by others prior to start of actual construction.
- Contractor has full access to the site and designated surrounding area.
- Contractor will use a custom external climbing scaffold for installation of a majority of the new building skin.
- Clam shell hangar doors will make use of a mobile crawler crane and man baskets to facilitate installation.
- Hydraulic “man lifts” will be used for lower level material installations where appropriate and feasible.
- Contaminated soils that may be excavated during slab on grade replacement can be delivered to an acceptable collection or disposal site within a 50 mile radius of the site.
- Internal access and work on the building skin will be performed by accessing those areas via the climbing scaffold and the use of climbing gear secured either to the scaffold or alternately the building structure directly.
- The use of internal building scaffolding is not anticipated for installation or work interior to the building. Work performed internally to the building will be completed using “man lifts”, or work from existing catwalks or with the use of climbing gear.
- Should it be decided to demolish the building it was estimated to remove all contaminated material from the steel structure on-site. Specific processes and methodologies were not identified, although the estimate is based on using a sand blast technique that would be performed inside of a temporary sprung structure erected onsite. Sand at 10#/sf was assumed and 0.5 mh/sf was used to estimate production. This arrived at a average unit costs for removal of contaminated coatings was used and applied to the expected surface area to exist on the steel members. Contaminated material was assumed to be collected in super sacks and trucked to a rail facility where the sacks could be loaded to rail cars and then transported to Arlington, Oregon for disposal at a certified disposal facility. Disposal fees were estimated at \$60/ton and transportation to the site was estimated at \$140/ton.

- Due to the fact that the structural steel used in the building is a non standard grade, only 50% of the normal and current value for steel salvage was allowed.
- Owner will provide and pay for any security access screening and training that may be required for access by construction labor and staff to the site.
- All hazardous materials have been removed except for that encapsulated on the structural steel during previous remediation efforts and any material that may be on or in the concrete slab on grade inside the structure.

Excluded Costs

The cost estimate excludes the following costs:

- Construction & environmental permits & fees.
- Non-construction or soft costs for, land, legal and owner administration costs.
- Material adjustment allowances above and beyond what is included at the time of the cost estimate.
- Hazardous material mitigation and/or removal except for any work required in removal of the hangar slab on grade or demolition of the structural steel should the building be demolished.

Hangar One Structural Analysis

Based on the structural evaluation and site observation of the Hangar structure, it appears that Hangar One was not only very well designed but remains in sound condition after 80 years. The structural deficiencies are minimal considering the size and the complexity of the building and the period when the building was designed and built, Most of the deficiencies observed are in the single angles in the braces and few Arch chords. The deficiencies noted here are to be expected considering that the design of the Hangar was done at a time when there was very limited knowledge of the seismic forces on the building. The seismic loads originally considered for the building as 1/6 of the dead weight of the building are lower than the seismic loads used for this analysis while the current codes and standards considers a number of factors in developing the seismic forces. Furthermore there have been significant changes in seismic resisting system requirements based on the knowledge gained from the recent earthquakes. Additionally, the wind loads originally considered were lower than the values calculated under current codes, especially for a Category III structure.

There is no retrofit required for Option A, accepting the liquefaction risk. Option B, however, requires retrofit as shown in the following details for the steel structure and for the assumed mitigated soil condition recommended by Section 5.0, Geotechnical Report. The retrofit options remain the same for Option C. The retrofit provided above also meets the requirement of higher occupancy of Option D with some added retrofit as required for higher wind loads of Category III.

Reference Documents

The cost estimate is based upon the following document listing:

As-Builts Drawings_AECOM
001-Cost Estimate-03-15-11.pdf
2003 Demo Hangar 1 Cost Estimate by DMJM.pdf
2008 Hangar 1 Cost Estimate by tbd consultants.pdf
20090506ASNLtrtoNASA.pdf
20090520OHPLtrToSchregardus.pdf
220px-Hangar_One_at_Moffett_Field_1963.jpg
8816-0005-0048 Final Implementation Work Plan.pdf
8816-0005-0048 Final Implementation Work Plan.pdf
Aerial_View_of_the_NASA_Ames_Research_Center_-_GPN-2000-001560.jpg
Dominguez to Penn.pdf
EPA Site29 AM Letter 5_20090001 (2).pdf
FINAL RFI for Hangar OneMoffett Field[1].docx
h1 with white roof and aeroplane.jpg
Hangar 1 CPTs.pdf
Hangar 1 Fact Sheet for RAB Mailing.pdf
Hangar One - Architectural Facade Study 06-30-10 1.pdf
Hangar One - Architectural Facade Study 06-30-10.pdf
Hangar One Final RFI Posted.pdf
Hangar One RFI_Page-Turnbull Response.pdf
Hangar1_asBuilts_30 percent PartialDraft_11-0309.pdf
hangar1_reuse_2001[1].pdf
Inside-of-Hangar-One-300x282.jpg
Mid Window.JPG
NASA Hangar One RFI- Response - Briggs.pdf
NASA_Navy MOU.Dec08.pdf
North-end-of-Hangar-One-300x161.jpg
SHPO Letter, Hangar One Fire Suppression.doc
SHPO Response to Hangar One Risk Assessment 1.pdf
Structural Analysis_Gravity_Seismic and Wind Vulnerability S 1.pdf

APPENDIX A – Cost Estimate

NASA Ames Research Center
Hangar 1 - Moffett Field Rehabilitation Project
Installation of Siding, Roof and Windows DRAFT_R3

Project name	NASA Moffett Hangar 1 Moffett Field CA
Estimator	Edgerton, R
Labor rate table	FACL2011
Equipment rate table	FACL2011
Bid date	11/7/2011
Project	Moffett Hangar 1
Project Number	421240.01.40
Market Segment	F&I
Business Group	GFI
Estimate Class	Class 5
Design Stage	Concept
Project Manager	J. Morgan/PDX
Design Manager	M.McCord/CVO
Report format	Sorted by 'Facility/Assembly/Milcon' 'Detail' summary Allocate addons Combine items Paginate
Cost index	California-San Jose

DETAIL REPORT

Project: NASA Moffett Hangar 1
 Design Stage: Concept
 Project No.: 421240.01.40

Estimator: Edgerton, R
 Estimate No.: <Estimate Number>
 Rev #/Date: <Rev. No. / Date>

Description	Item	Takeoff Quantity	Total Cost/Unit	Total Amount
A Option A: Basic Re-Skinning, Maintain Existing Hangar Use				
03900 Clean & Patch Concrete				
<i>A01060101 Concrete Wall Finishes</i>				
Patching concrete, walls, epoxy grout, 1/2" deep, including chipping, cleaning and epoxy grout	2150	22,000.00 sf	46.85 /sf	1,030,777
				1,030,777
<i>A01060101 Concrete Wall Finishes</i>				
Clean & Patch Concrete		22,000.00 sf	46.85 /sf	1,030,777
05300 Redwood Deck Substitution				
<i>A01020203 Roof Decks and Slabs</i>				
Rent crawler mounted, lattice boom crane, cable, 200 ton, 70' boom	1400	25.00 day	4,446.60 /day	111,165
Metal decking composite galv non-cellular 2' 20 ga	5300	196,180.00 sf	5.38 /sf	1,054,835
Sheet metal edge closure form, to 12", w/2 bends, 18 ga	7100	500.00 lf	8.18 /lf	4,091
				1,170,090
<i>A01030102 Insulation and Vapor Barrier</i>				
Vapor Retarders, building paper, asphalt felt sheathing paper, 15#	0400	196.18 sq	33.76 /sq	6,623
				6,623
<i>A01040101 Roof Covering</i>				
Rolling Mill Setup Fee	0500	1.00 ls	195,572.60 /ls	195,573
				195,573
<i>A01040101 Roof Covering</i>				
Redwood Deck Substitution		196,180.00 sf	7.00 /sf	1,372,286
05400 Pivot Pin Enclosure Rehab				
<i>A01160101 Substructure & Superstructure</i>				
Pivot Pin enclosure	0100	1.00 ls	35,144.39 /ls	35,144
				35,144
<i>A01160101 Substructure & Superstructure</i>				
Pivot Pin Enclosure Rehab		1.00 ls	35,144.39 /ls	35,144
05517 Roof Walkway				
<i>A0102029X Other Roof Systems</i>				
Railing, industrial, welded, steel pipe, 2 rails, 3'-6" high, posts @ 5' O.C., 1-1/2" dia x 42" H, shop fabricated	0020	1,584.00 lf	56.65 /lf	89,740
Railing, industrial, welded, steel, shop fabricated, for 4' x 10 ga kick plate, add	0200	1,584.00 lf	8.98 /lf	14,216
Floor grating, steel, painted, 3/4" x 1/8" bearing bars @ 1-3/16" O.C., cross bars @ 2" O.C., over 300 S.F., field fabricated from panels	0464	2,376.00 sf	32.31 /sf	76,764
				180,721
<i>A0102029X Other Roof Systems</i>				
Roof Walkway		792.00 lf	228.18 /lf	180,721
07300 Main Bldg Corrugated Roofing/ExpJts/Hatch				
<i>A01040101 Roof Covering</i>				
Anchor "U" Clip	0100	81,146.00 ea	4.16 /ea	337,479
Anchor bolts, J-type, 5/16" diameter x 12" long, galvanized, includes nut and washer	2200	81,146.00 ea	16.00 /ea	1,298,679
Steel roofing panels, attached to steel frame, corrugated or ribbed, galvanized & Painted, 20 gauge	0400	543,350.00 sf	11.22 /sf	6,094,581
				7,730,738
<i>A01040101 Roof Covering</i>				
<i>A01040104 Flashing and Trim</i>				
Expansion joint, Copper Sheet 22ga x 24"	1900	1,080.00 lf	72.62 /lf	78,430
				78,430
<i>A01040105 Roofing Openings & Supports</i>				
Roof Hatches, with curb, 1" fiberglass insulation, galvanized steel curb & cover, 2'-6" x 8'	1500	2.00 ea	2,804.61 /ea	5,609
				5,609
<i>A01040105 Roofing Openings & Supports</i>				
Main Bldg Corrugated Roofing/ExpJts/Hatch		543,350.00 sf	14.38 /sf	7,814,777
07600 Ridge Vent System Complete (manual ops)				
<i>A01040104 Flashing and Trim</i>				
Sheet metal flashing, stainless steel, flexible sheets, .018" thick, 26 gauge, including up to 4 bends	9100	4,400.00 sf	18.83 /sf	82,829
Coping, stainless steel, 26 ga., 16" wall	9985	2,200.00 lf	35.52 /lf	78,132
Drip edge, galvanized, mill finish, 8" wide	0500	2,200.00 lf	3.43 /lf	7,548
Ridge Vent	2300	1,100.00 lf	533.94 /lf	587,335
				755,844
<i>A01040104 Flashing and Trim</i>				
Ridge Vent System Complete (manual ops)		1.00 ls	755,844.46 /ls	755,844
07600 Clam Shell Door Flashing				
<i>A01040104 Flashing and Trim</i>				
Flashing, galvanized steel, .018", 26 ga.	0005	2,400.00 sf	47.55 /sf	114,128
Expansion joint, roof to wall joint with extruded aluminum cover	2500	2,200.00 lf	69.01 /lf	151,820
				265,948
<i>A01040104 Flashing and Trim</i>				
Clam Shell Door Flashing		2.00 ls	132,974.10 /ls	265,948
08100 Single Exterior Doors				
<i>A01030302 Solid Doors</i>				
Doors, fire, flush, "A" label, 3 hour, composite, 18 ga., 3'-0" x 7'-0"	0680	23.00 ea	1,430.27 /ea	32,896
Add for galvanizing, average cost per leaf	2025	23.00 leaf	65.57 /leaf	1,508
Add for baked enamel finish, average cost per leaf	2040	23.00 leaf	108.89 /leaf	2,505
Metal doors, rated, receive, sort and spread, per manhour	5000	11.50 mh	81.89 /mh	942
				37,851
<i>A01030302 Solid Doors</i>				
Single Exterior Doors		23.00 leaf	1,645.68 /leaf	37,851
08100 Double Leaf Exterior Doors				
<i>A01030302 Solid Doors</i>				
Doors, fire, flush, "A" label, 3 hour, composite, 18 ga., 3'-0" x 7'-0"	0680	2.00 ea	1,430.27 /ea	2,861
Add for galvanizing, average cost per leaf	2025	2.00 leaf	65.58 /leaf	131
Add for baked enamel finish, average cost per leaf	2040	2.00 leaf	108.89 /leaf	218
Metal doors, rated, receive, sort and spread, per manhour	5000	0.50 mh	81.88 /mh	41
				3,250
<i>A01030302 Solid Doors</i>				
Double Leaf Exterior Doors		2.00 leaf	1,625.21 /leaf	3,250
08115 Single Leaf Exterior Frames				
<i>A01030302 Solid Doors</i>				
Frames, steel, knock down, hollow metal, for welded frames, add	4900	23.00 ea	112.41 /ea	2,585
Steel frames, KD, 14 ga., "A" or "B" label, to 5-3/4" throat, to 3'-0" x 7'-0"	5375	23.00 ea	478.55 /ea	11,007
Steel frames, add for baked enamel finish	6400	23.00 ea	55.58 /ea	1,278
Steel frames, add for galvanizing	6500	23.00 ea	21.08 /ea	485
Door frames, receive, sort and spread, per manhour	9090	11.50 mh	81.90 /mh	942
				16,297
<i>A01030302 Solid Doors</i>				

DETAIL REPORT

Project: NASA Moffett Hangar 1
 Design Stage: Concept
 Project No.: 421240.01.40

Estimator: Edgerton, R
 Estimate No.: <Estimate Number>
 Rev #/Date: <Rev. No. / Date>

Description	Item	Takeoff Quantity	Total Cost/Unit	Total Amount
Single Leaf Exterior Frames		23.00 ea	708.57 /ea	16,297
08115 Double Leaf Exterior Frame				
<i>A01030302 Solid Doors</i>				
Frames, steel, knock down, hollow metal, for welded frames, add	4900	1.00 ea	112.40 /ea	112
Steel frames, KD, 14 ga, "A" or "B" label, to 8-3/4" throat, to 3'-0" x 7'-0"	6175	1.00 ea	664.05 /ea	664
Steel frames, KD, 14 ga, "A" or "B" label, to 8-3/4" throat, to 6'-0" x 7'-0"	6220	1.00 ea	773.79 /ea	774
Steel frames, add for baked enamel finish	6400	1.00 ea	55.59 /ea	56
Steel frames, add for galvanizing	6500	1.00 ea	21.09 /ea	21
Door frames, receive, sort and spread, per manhour	9090	0.50 mh	81.86 /mh	41
<i>A01030302 Solid Doors</i>			<i>/ea</i>	<i>1,668</i>
Double Leaf Exterior Frame		1.00 ea	1,667.85 /ea	1,668
08410 Roll-Up Utility Doors				
<i>A01040401 Overhead and Roll-up Doors</i>				
Doors, vertical coiling, motorized, steel, 14 gauge, 10' x 20', incl. frame and control panel	0100	12.00 ea	31,139.37 /ea	373,672
<i>A01040401 Overhead and Roll-up Doors</i>			<i>/ea</i>	<i>373,672</i>
Roll-Up Utility Doors		12.00 ea	31,139.37 /ea	373,672
08900 Corrugated Windows				
<i>A01030201 Windows</i>				
Corrugated Windows, Steel Frame	0100	42,780.00 sf	318.24 /sf	13,614,365
<i>A01030201 Windows</i>			<i>/sf</i>	<i>13,614,365</i>
Corrugated Windows		42,780.00 sf	318.24 /sf	13,614,365
08900 Flat Glass Windows				
<i>A01030201 Windows</i>				
Windows, steel, custom units, wire reinforced glass	2100	35,680.00 sf	77.07 /sf	2,749,845
<i>A01030201 Windows</i>			<i>/sf</i>	<i>2,749,845</i>
Flat Glass Windows		35,680.00 sf	77.07 /sf	2,749,845
09250 Interior Finishes				
<i>A01030102 Insulation and Vapor Barrier</i>				
Blanket insulation, for walls or ceilings, unfaced fiberglass, 3-1/2" thick, R13, 15" wide	0820	1,875.00 sf	1.17 /sf	2,195
<i>A01030102 Insulation and Vapor Barrier</i>			<i>/sf</i>	<i>2,195</i>
<i>A01050401 Compartments, Cubicles and Toilet Partitions</i>				
Partitions, toilet, cubicles, ceiling hung, stainless steel	0500	20.00 ea	1,796.64 /ea	35,933
<i>A01050401 Compartments, Cubicles and Toilet Partitions</i>			<i>/ea</i>	<i>35,933</i>
<i>A01060103 Gypsum Wallboard Finishes</i>				
3-5/8" Metal studs, galv, 20 ga., 16" oc, non load bearing, >10' ht.	2825	1,875.00 sf	3.59 /sf	6,740
Framing, 2x4 fire treated, trimmers/furring for door/window frames	4025	0.04 mbf	4,567.00 /mbf	183
18 to 16 ga x 1-1/2" channel bridging, studs 16" oc	6000	1.50 cdf	212.33 /cdf	319
Average cost, flate plate backing to 6" wide, 16 gauge	6022	30.00 lf	5.68 /lf	170
Studs, drive pins & studs, 1/4" & 3/8" diameter	6035	0.25 c	7.60 /c	2
Pack void between top track and flutes and seal both sides	7450	150.00 lf	6.97 /lf	1,046
Track gasketing, neoprene closed cell, 1/4" x 3/4"	7500	300.00 lf	5.48 /lf	1,643
Gypsum wallboard, on walls, fire resistant, taped & finished (level 4 finish), 5/8" thick	2150	3,750.00 sf	2.55 /sf	9,576
<i>A01060103 Gypsum Wallboard Finishes</i>			<i>/sf</i>	<i>19,678</i>
<i>A01060201 Room Finishes</i>				
Interior Finishes	3000	1,000.00 sf	88.87 /sf	88,867
<i>A01060201 Room Finishes</i>			<i>/sf</i>	<i>88,867</i>
Interior Finishes		1,875.00 sf	78.23 /sf	146,673
21310 Fire Sprinklers Toilet Rooms (1,000sf) and Utility Rooms (1,000sf)				
<i>A01080201 Pipes and Fittings</i>				
Pipe, fittings and valves, steel, black, grooved joint, 20" diameter, schedule 40, includes coupling & clevis type hanger 10' O.C.	1200	2.00 lf	539.29 /lf	1,079
Fire protection loops to 2.5" dia., including hangers & fittings	1225	1,100.00 sf	1.43 /sf	1,571
Sprinkler head distribution to 1.25" dia., including hangers/fittings	1250	1,100.00 sf	1.42 /sf	1,559
Backflow pvnr, OS&Y v,&4 tst cocks, rddc press, flg, iron, 6" pipe	5720	2.00 ea	10,423.19 /ea	20,846
<i>A01080201 Pipes and Fittings</i>			<i>/sf</i>	<i>25,055</i>
<i>A01080202 Valves and Hydrants</i>				
Valves, iron body, swing check, flanged, 125 lb., 6"	6070	2.00 ea	2,567.55 /ea	5,135
<i>A01080202 Valves and Hydrants</i>				<i>5,135</i>
<i>A01100201 Sprinkler Heads and Release Dev.</i>				
Pendant or upright heads, 135 deg to 286 deg F, 1/2" NPT, 1/2" orifice	3740	7.00 ea	84.43 /ea	591
Sprinkler System Components, valves, dry pipe air check type, 3" size	8000	1.00 ea	3,483.17 /ea	3,483
<i>A01100201 Sprinkler Heads and Release Dev.</i>				<i>4,074</i>
<i>A01100301 Sprinkler Heads & System</i>				
Single standpipe connection (FHV or FDC), polished brass, 2-1/2" x 3"	7180	8.00 ea	647.34 /ea	5,179
2-way standpipe connection (FHV/FDC), polishd brass, 2-1/2" x 2-1/2" x 6"	7330	2.00 ea	1,542.59 /ea	3,085
<i>A01100301 Sprinkler Heads & System</i>				<i>8,264</i>
Fire Sprinklers Toilet Rooms (1,000sf) and Utility Rooms (1,000sf)		2,000.00 sf	21.26 /sf	42,528
21310 HEF Fire Suppression and Alarm at Hangar				
<i>A01100201 Sprinkler Heads and Release Dev.</i>				
HEF Fire Suppression & Fire Alarm Allowance, based on historical project data	----	200,000.00 sqft	35.74 /sqft	7,148,876
<i>A01100201 Sprinkler Heads and Release Dev.</i>				<i>7,148,876</i>
HEF Fire Suppression and Alarm at Hangar		200,000.00 sf	35.74 /sf	7,148,876
22405 Commercial Plumbing, Conceptual				
<i>A01080101 Waterclosets</i>				
Water closet, bowl only, w/ flush valve, seat, wall hung	3100	13.00 ea	1,173.79 /ea	15,259
Rough in water supply, waste & vent for wall hung water closet	3200	13.00 ea	2,597.30 /ea	33,765
Carriers/supports, water closet, siphon jet, horizontal, adjustable, caulk, single, 4" pipe size	7040	13.00 ea	1,618.25 /ea	21,037
<i>A01080101 Waterclosets</i>			<i>/ea</i>	<i>70,061</i>
<i>A01080102 Urinals</i>				
Urinal, wall hung, vitreous china, with hanger & self-closing valve, siphon jet type	3100	3.00 ea	1,201.10 /ea	3,603
Urinal, wall hung, rough-in, supply, waste and vent	3300	3.00 ea	1,682.06 /ea	5,046
Carriers/supports, urinal, wall mounted, plate type system	6300	3.00 ea	664.06 /ea	1,992

DETAIL REPORT

Project: NASA Moffett Hangar 1
 Design Stage: Concept
 Project No.: 421240.01.40

Estimator: Edgerton, R
 Estimate No.: <Estimate Number>
 Rev #/Date: <Rev. No. / Date>

Description	Item	Takeoff Quantity	Total Cost/Unit	Total Amount
A01080102 Urinals			/ea	10,642
A01080103 Lavatories				
Lavatory, vanity top, vitreous china, white, single bowl, 20" x 16", includes trim	2900	6.00 ea	853.22 /ea	5,119
Lavatory, vanity top, rough-in, supply, waste and vent	3580	6.00 ea	1,460.16 /ea	8,761
Carriers/supports, lavatory, concealed arm, wall mounted, in stud or masonry, flat slab fixture	3700	6.00 ea	559.36 /ea	3,356
A01080103 Lavatories			/ea	17,236
A01080104 Sinks				
Service sink, faucet and drain, floor/corner mtd, 28"x28" PE on CI	6650	2.00 ea	2,030.43 /ea	4,061
Rough in water supply, waste & vent for floor mtd. service sinks	6790	2.00 ea	3,125.16 /ea	6,250
Fcts/flush valve, autmtc flush sensor and opertr for urinals wtrclsts	0972	6.00 ea	913.59 /ea	5,482
Faucets/fittings, lavatory faucet, automatic sensor and operator, with faucet head, residential	2810	6.00 ea	870.87 /ea	5,225
A01080104 Sinks			/ea	21,018
A01080106 Drinking Fountains & Coolers				
Carriers/supports, drinking fountain, wall mounted, plate type with studs, top back plate	0600	1.00 ea	289.13 /ea	289
Water cooler, wall mounted, non-recessed, dual height, 14.3 GPH	1040	1.00 ea	2,625.09 /ea	2,625
Water cooler, for supply, waste and vent, all coolers	9800	1.00 ea	973.23 /ea	973
A01080106 Drinking Fountains & Coolers			/ea	3,887
A01080201 Pipes and Fittings				
Cleanout, floor type, round or square, scoriated nickel bronze top, 3" pipe size	0120	12.00 ea	572.53 /ea	6,870
Cleanout tee, cast iron, B. & S., 4" pipe size, includes countersunk plug	0240	2.00 ea	870.62 /ea	1,741
3/4" copper type L w/ fittings & hangers 10' oc, wall hydrants	2450	100.00 lf	18.21 /lf	1,821
Water sply ms, dom/cornl, brz, flgd, compound, 8" dia, to 1,800 GPM	2700	1.00 ea	22,857.80 /ea	22,858
Backflow pvnter, OS&Y v.&4 tst cocks, rddc press, flg, iron, 3" pipe	5680	1.00 ea	5,628.96 /ea	5,629
Hydrant, wall type, moderate climate, bronze, anti-siphon,encased, 1" I.P.S. connection	0300	4.00 ea	1,368.76 /ea	5,475
Hydrant, wall type, non-freeze, bronze, exposed, 3/4" I.P.S connection, 4" to 9" thick wall	1100	2.00 ea	835.90 /ea	1,672
A01080201 Pipes and Fittings			/sf	46,066
A01080301 Waste Pipe and Fittings				
6" Cast iron single hub w/ fittings, extra heavy, buried	5000	500.00 lf	75.59 /lf	37,796
Trench for buried waste or drain pipe, avg.12" W, up to 24" D	6000	500.00 lf	2.90 /lf	1,448
Hand clean and trim trench for waste/drain lines	6010	500.00 lf	4.55 /lf	2,276
Backfill and compact piping trench, avg. 12" wide to, 24" deep	6015	500.00 lf	3.83 /lf	1,917
Bedding, sand, for waste/drain piping, to 6" deep	6025	9.26 cy	47.45 /cy	439
A01080301 Waste Pipe and Fittings			/sf	43,877
A01080303 Floor Drains				
Drain, floor, medium duty, cast iron, deep flange, 7" diameter top, 2" and 3" pipe size	2040	4.00 ea	460.60 /ea	1,842
Drain, floor, medium duty, cast iron, deep flange, 7" diameter top, for polished bronze top, add	2120	4.00 ea	166.41 /ea	666
Drain, floor, heavy duty with sediment bucket, cast iron, 12" diameter loose grate, 2", 3", 4", 5" and 6" pipe size	2420	2.00 ea	1,239.24 /ea	2,478
A01080303 Floor Drains			/ea	4,987
A01080603 Interceptors				
Interceptor, oil, fabricated steel, 100 GPM, 3" pipe size	4220	1.00 ea	22,492.92 /ea	22,493
A01080603 Interceptors			/ea	22,493
A01090105 Hot Water Supply System (Cent Plant)				
Comm'l water heater, 100 deg rise, elec, 50 gal., 9 kW, 37 GPH, 208V	4140	1.00 ea	6,735.13 /ea	6,735
A01090105 Hot Water Supply System (Cent Plant)			/ea	6,735
Commercial Plumbing, Conceptual		1,000.00 sf	247.00 /sf	247,002
23525 HVAC Restrooms & Electrical				
A0109039X Other Cooling generating Systems				
Fan coil A.C., direct expansion for use w/air cooled condensing unit, 5 ton cooling, includes filters and controls	1000	1.00 ea	3,131.78 /ea	3,132
A0109039X Other Cooling generating Systems			/sf	3,132
A01090401 Air Distribuion, Cooling and Heating				
Rectangular galv steel duct w/ fittings & supports, garage exhaust	4000	495.00 lb	10.90 /lb	5,397
Exhaust fans, centrifugal, axial or v-belt, avg. cost per cfm	9700	1,500.00 cfm	0.82 /cfm	1,237
A01090401 Air Distribuion, Cooling and Heating			/sf	6,634
A01090601 HVAC Controls				
Electric timeclock controls, shell equipment only	0010	1.00 ls	13,179.15 /ls	13,179
A01090601 HVAC Controls			/sf	13,179
A01090702 Air Side Testing and Balancing-Heating, Cooling and Exhaust Systems				
Test & balance, dryside	5000	8.00 hr	219.65 /hr	1,757
A01090702 Air Side Testing and Balancing-Heating, Cooling and Exhaust Systems			/sf	1,757
HVAC Restrooms & Electrical		1,500.00 sf	16.47 /sf	24,702
26022 Core & Shell Electrical, Conceptual				
A01110101 Main Transformers				
Transformer, dry-type, 3 phase 480 V primary 120/208 V secondary, 112.5 kVA	3900	1.00 ea	13,634.61 /ea	13,635
A01110101 Main Transformers			/ls	13,635
A01110103 Main Switchboards				
Main switchboards,w/ disconnect & CB, 3P, 4W, avg cost per amp	6000	1,000.00 amp	48.31 /amp	48,305
Distribution switchboards,120/208v or 277/480v, avg cost per amp	2000	1,000.00 amp	41.05 /amp	41,051
A01110103 Main Switchboards			/amp	89,356
A01110105 Panels				
Panelboards, 3 phase 4 wire, main lugs, 120/208 V, 225 amp, 42 circuits, NQOD, incl 20 A 1 pole plug-in breakers	1000	2.00 ea	5,742.96 /ea	11,486
Panelboards, 3 phase 4 wire, main lugs, 277/480 V, 225 amp, 36 circuits, NEHB, incl 20 A 1 pole plug-in breakers	1450	2.00 ea	8,143.53 /ea	16,287
A01110105 Panels			/ea	27,773
A01110107 Motor Circuit Breakers				

DETAIL REPORT

Project: NASA Moffett Hangar 1
 Design Stage: Concept
 Project No.: 421240.01.40

Estimator: Edgerton, R
 Estimate No.: <Estimate Number>
 Rev #/Date: <Rev. No. / Date>

Description	Item	Takeoff Quantity	Total Cost/Unit	Total Amount
A01110107 Motor Circuit Breakers				
Motor connections, flexible conduit and fittings, 1 phase, 115 volt, up to 1 HP motor	0020	2.00 ea	153.45 /ea	307
Motor connections, flexible conduit and fittings, 3 phase, 230 volt, 25 HP motor	0200	4.00 ea	464.86 /ea	1,859
Motor starter, combination, with fused switch, size 1, 10 HP, NEMA 1	1600	4.00 ea	2,140.71 /ea	8,563
Motor starter, magnetic FVNR, size 4, 480 volt, 100 HP, NEMA 12, incl enclosure & heaters	4000	4.00 ea	7,111.71 /ea	28,447
<i>A01110107 Motor Circuit Breakers</i>				39,176
A01110201 Branch Wiring				
Rigid galvanized steel conduit elbows, 1/2" diameter, to 15' high	2000	30.00 ea	60.58 /ea	1,817
Branch power, to 3/4" EMT w/ conductors, avg. cost/sf, core & shell	6010	3,000.00 sf	2.56 /sf	7,688
Switchboard instruments, 3 phase 4 wire, AC indicating, wattmeter	0300	2.00 ea	7,912.62 /ea	15,825
Switchboard instruments, ground fault protection, zero sequence	0600	2.00 ea	12,649.14 /ea	25,298
<i>A01110201 Branch Wiring</i>				50,629
A01110202 Lighting Equipment				
Lighting allowance, fixtures, raceway/wiring, core & shell	9010	3,000.00 sf	1.31 /sf	3,926
Lighting controls allowance, relay panels, core & shell	9110	3,000.00 sf	0.44 /sf	1,318
<i>A01110202 Lighting Equipment</i>				5,244
A01110203 Grounding Systems				
Building grounding system, average cost per sf	5000	3,000.00 sf	0.23 /sf	695
<i>A01110203 Grounding Systems</i>				695
Core & Shell Electrical, Conceptual		1,500.00 sf	151.01 /sf	226,508
26022 Electrical Service, 1200A				
<i>A01110101 Main Transformers</i>				
Transformer, oil-filled, 15 kV with taps, 480 V secondary 3 phase, 1500 kVA, pad mounted	0600	4.00 ea	75,258.24 /ea	301,033
Transformer, dry-type, 3 phase 480 V primary 120/208 V secondary, 225 kVA	4300	12.00 ea	22,898.63 /ea	274,784
<i>A01110101 Main Transformers</i>				575,816
<i>A01110103 Main Switchboards</i>				
Main switchboards,w/ disconnect & CB, 3P, 4W, avg cost per amp	6000	4,800.00 amp	48.31 /amp	231,863
Distribution switchboards,120/208v or 277/480v, avg cost per amp	2000	2,400.00 amp	41.05 /amp	98,523
<i>A01110103 Main Switchboards</i>				330,386
<i>A01110105 Panels</i>				
Panelboards, 3 phase 4 wire, main lugs, 120/208 V, 225 amp, 42 circuits, NQOD, incl 20 A 1 pole plug-in breakers	1000	24.00 ea	5,742.97 /ea	137,831
Panelboards, 3 phase 4 wire, main lugs, 277/480 V, 225 amp, 36 circuits, NEHB, incl 20 A 1 pole plug-in breakers	1450	24.00 ea	8,143.52 /ea	195,445
<i>A01110105 Panels</i>				333,276
<i>A01110107 Motor Circuit Breakers</i>				
Motor connections, flexible conduit and fittings, 3 phase, 230 volt, 25 HP motor	0200	4.00 ea	464.86 /ea	1,859
Motor starter, combination, with fused switch, size 1, 10 HP, NEMA 1	1600	4.00 ea	2,140.71 /ea	8,563
<i>A01110107 Motor Circuit Breakers</i>				10,422
<i>A0111019X Service and Distribution</i>				
Wire, copper, stranded, 600 volt, 600 kcmil, type XHHW, in raceway	3340	90.00 clf	3,550.47 /clf	319,542
Electrical Underground Ducts and Manholes, PVC, conduit with coupling, 4" diameter, schedule 40, installed by direct burial in slab or duct bank	1070	2,000.00 lf	23.03 /lf	46,052
Electrical Underground Ducts and Manholes, PVC, conduit with coupling, 6" diameter, schedule 40, installed by direct burial in slab or duct bank	1090	4,000.00 lf	42.49 /lf	169,955
Electrical Underground Ducts and Manholes, PVC, bell end and cap, 4" diameter, schedule 40, installed by direct burial in slab or duct bank	1370	40.00 ea	108.10 /ea	4,324
Electrical Underground Ducts and Manholes, PVC, bell end and cap, 6" diameter, schedule 40, installed by direct burial in slab or duct bank	1390	32.00 ea	160.12 /ea	5,124
Electrical Underground Ducts and Manholes, PVC, base spacer, 4" diameter, schedule 40, installed by direct burial in slab or duct bank	1470	400.00 ea	25.96 /ea	10,385
Electrical Underground Ducts and Manholes, PVC, base spacer, 6" diameter, schedule 40, installed by direct burial in slab or duct bank	1490	800.00 ea	32.12 /ea	25,698
<i>A0111019X Service and Distribution</i>				581,080
<i>A01110201 Branch Wiring</i>				
Cable terminations, indoor, insulation diameter range, 15 kV, .975" to 1.570", pad mount	0900	24.00 ea	475.00 /ea	11,400
Medium-cable single cable, copper, XLP shielding, ungrounded neutral, 15 kV, 1/0, in conduit, excl splicing & terminations	1800	70.00 clf	1,256.94 /clf	87,986
Switchboard instruments, 3 phase 4 wire, AC indicating, wattmeter	0300	4.00 ea	7,912.62 /ea	31,650
Switchboard instruments, ground fault protection, zero sequence	0600	4.00 ea	12,649.14 /ea	50,597
<i>A01110201 Branch Wiring</i>				181,633
Electrical Service, 1200A		4.00 svcs	503,153.39 /svcs	2,012,614
26024 Clam Shell Door Motors				
<i>A01040402 Hanger Doors</i>				
Motor connections, flexible conduit and fittings, 3 phase, 230 volt, 25 HP motor	0200	1.00 ea	3,611.59 /ea	3,612
Motor replacement, special fabrication to match existing on external	1600	1.00 ea	19,966.84 /ea	19,967
<i>A01040402 Hanger Doors</i>				23,579
Clam Shell Door Motors		1.00 ls	23,578.43 /ls	23,578
26024 Clam Shell Door Service				
<i>A01040402 Hanger Doors</i>				
Clam Shell Dppr Pivot Pin	0100	2.00 ea	38,187.36 /ea	76,375
Truck & Gear Box Service	0200	3.00 ea	4,097.73 /ea	12,293
Motor Service	1600	3.00 ea	6,355.29 /ea	19,066
<i>A01040402 Hanger Doors</i>				107,734
Clam Shell Door Service		3.00 ea	35,911.26 /ea	107,734
26024 400hz recepts				
<i>A01110107 Motor Circuit Breakers</i>				
400hz inverter	0220	4.00 ea	34,984.35 /ea	139,937
<i>A01110107 Motor Circuit Breakers</i>				139,937
<i>A0111019X Service and Distribution</i>				
Wire, copper, stranded, 600 volt, #8, type THWN-THHN, in raceway	1300	60.00 clf	197.77 /clf	11,866
<i>A0111019X Service and Distribution</i>				11,866

DETAIL REPORT

Project: NASA Moffett Hangar 1
 Design Stage: Concept
 Project No.: 421240.01.40

Estimator: Edgerton, R
 Estimate No.: <Estimate Number>
 Rev #/Date: <Rev. No. / Date>

Description	Item	Takeoff Quantity	Total Cost/Unit	Total Amount
A01110201 Branch Wiring				
Aluminum conduit, 1" diameter, to 15' H, incl 2 terminations, 2 elbows & 11 beam clamps per 100 LF	0700	1,500.00 lf	21.29 /lf	31,940
Outlet boxes, cast, FDC, 2 gang, 3/4" hub	1820	20.00 ea	209.07 /ea	4,181
400hz receptacle	3980	20.00 ea	259.33 /ea	5,187
<i>A01110201 Branch Wiring</i>			<i>/sf</i>	<i>41,308</i>
400hz receipts		4.00 area	48,278.06 /area	193,112
26024 DC receipts				
<i>A01110107 Motor Circuit Breakers</i>				
DC rectifier	0220	4.00 ea	20,400.55 /ea	81,602
<i>A01110107 Motor Circuit Breakers</i>			<i>/ea</i>	<i>81,602</i>
<i>A0111019X Service and Distribution</i>				
Wire, copper, stranded, 600 volt, #8, type THWN-THHN, in raceway	1300	60.00 clf	197.77 /clf	11,866
<i>A0111019X Service and Distribution</i>			<i>/fs</i>	<i>11,866</i>
<i>A01110201 Branch Wiring</i>				
Rigid galvanized steel conduit, 1" diameter, to 15' H, incl 2 terminations, 2 elbows & 11 beam clamps per 100 LF	1800	1,500.00 lf	23.60 /lf	35,405
Outlet boxes, cast, FDC, 2 gang, 3/4" hub	1820	20.00 ea	209.07 /ea	4,181
DC receptacle	3980	20.00 ea	259.33 /ea	5,187
<i>A01110201 Branch Wiring</i>			<i>/sf</i>	<i>44,773</i>
DC receipts		4.00 area	34,560.31 /area	138,241
26026 Metal Halide and HPS Hi Bay Lighting				
<i>A0111019X Service and Distribution</i>				
Wire, copper, stranded, 600 volt, #8, type THWN-THHN, in raceway	1300	200.00 clf	475.86 /clf	95,172
<i>A0111019X Service and Distribution</i>			<i>/fs</i>	<i>95,172</i>
<i>A01110201 Branch Wiring</i>				
Rigid galvanized steel conduit, 3/4" diameter, to 15' H, incl 2 terminations, 2 elbows & 11 beam clamps per 100 LF	1770	5,000.00 lf	54.56 /lf	272,795
<i>A01110201 Branch Wiring</i>			<i>/sf</i>	<i>272,795</i>
<i>A01110202 Lighting Equipment</i>				
High pressure sodium fixture, interior, recessed, square, 1000 W, incl lamps, and mounting hardware	0840	50.00 ea	3,906.50 /ea	195,325
Metal halide fixture, interior, vaporproof, pendent, 1000 W, incl lamps, and mounting hardware	3420	50.00 ea	5,181.50 /ea	259,075
<i>A01110202 Lighting Equipment</i>			<i>/fs</i>	<i>454,400</i>
Metal Halide and HPS Hi Bay Lighting		100.00 fixt	8,223.68 /fixt	822,368
26026 T8 interior lighting				
<i>A0111019X Service and Distribution</i>				
Wire, copper, stranded, 600 volt, #10, type THWN-THHN, in raceway	1250	50.00 clf	146.36 /clf	7,318
<i>A0111019X Service and Distribution</i>			<i>/fs</i>	<i>7,318</i>
<i>A01110201 Branch Wiring</i>				
Rigid galvanized steel conduit, 3/4" diameter, to 15' H, incl 2 terminations, 2 elbows & 11 beam clamps per 100 LF	1770	1,500.00 lf	18.71 /lf	28,062
<i>A01110201 Branch Wiring</i>			<i>/sf</i>	<i>28,062</i>
<i>A01110202 Lighting Equipment</i>				
Fluorescent fixture, interior, strip, pendent mounted, industrial, white porcelain enamel, rs, 2-32 w t8, 41, incl lamps, mounting hardware and connections	3110	100.00 ea	328.88 /ea	32,888
<i>A01110202 Lighting Equipment</i>			<i>/fs</i>	<i>32,888</i>
T8 interior lighting		100.00 fixt	682.68 /fixt	68,268
26026 Telecom horizontal				
<i>A01110201 Branch Wiring</i>				
Beam clamp and LV cable ring	5550	5,000.00 ea	30.58 /ea	152,912
<i>A01110201 Branch Wiring</i>			<i>/sf</i>	<i>152,912</i>
<i>A0111019X Other Communication & Alarm Systems</i>				
Unshielded twisted pair (UTP) cable, solid, plenum, #24, 4 pair, category 6	7242	300.00 clf	286.03 /clf	85,808
Unshielded twisted pair (UTP) jack, RJ-45, category 6	7316	200.00 ea	25.78 /ea	5,156
Voice/Data outlets, two jack opening, excl voice/data devices	0140	100.00 ea	27.60 /ea	2,760
<i>A0111019X Other Communication & Alarm Systems</i>			<i>/fs</i>	<i>93,725</i>
Telecom horizontal		100.00 outl	2,466.36 /outl	246,636
26030 Receptacles				
<i>A0111019X Service and Distribution</i>				
Wire, copper, stranded, 600 volt, #10, type THWN-THHN, in raceway	1250	100.00 clf	146.36 /clf	14,636
<i>A0111019X Service and Distribution</i>			<i>/fs</i>	<i>14,636</i>
<i>A01110201 Branch Wiring</i>				
Rigid galvanized steel conduit, 3/4" diameter, to 15' H, incl 2 terminations, 2 elbows & 11 beam clamps per 100 LF	1770	3,200.00 lf	18.71 /lf	59,865
Outlet boxes, cast, weatherproof receptacle cover, 1 gang	1600	80.00 ea	32.09 /ea	2,567
Outlet boxes, cast, FSC, 1 gang, 3/4" hub	1760	80.00 ea	145.51 /ea	11,641
Duplex receptacle, ground fault interrupting, 20 amp	2482	80.00 ea	113.77 /ea	9,101
<i>A01110201 Branch Wiring</i>			<i>/sf</i>	<i>83,174</i>
Receptacles		80.00 rcpt	1,222.62 /rcpt	97,810
26710 Com rooms				
<i>A01120103 Telephone Systems</i>				
Electrical Underground Ducts and Manholes, PVC, conduit with coupling, 4" diameter, schedule 40, installed by direct burial in slab or duct bank	1070	10,000.00 lf	23.03 /lf	230,260
Electrcl undgrnd ducts and manholes, hand holes, precast concrete, with concrete cover, 4'x4'x4" deep, excludes excavation, backfill and cast place concrete	1000	8.00 ea	4,228.71 /ea	33,830
<i>A01120103 Telephone Systems</i>			<i>/fs</i>	<i>264,090</i>
<i>A0112019X Other Communication & Alarm Systems</i>				
Com room rack allowance	3040	4.00 ea	11,880.04 /ea	47,520
Fiber optic connector	0300	96.00 ea	83.75 /ea	8,040
Fiber optics cable, outdoor, 62.5 microns, aerial/duct	1040	5,000.00 lf	3.00 /lf	14,976
<i>A0112019X Other Communication & Alarm Systems</i>			<i>/fs</i>	<i>70,536</i>
Com rooms		4.00 ea	83,656.50 /ea	334,626
26712 Public Address System				
<i>A01120104 Public Address Systems</i>				

DETAIL REPORT

Project NASA Moffett Hangar 1
 Design Stage: Concept
 Project No.: 421240.01.40

Estimator: Edgerton, R
 Estimate No.: <Estimate Number>
 Rev #/Date: <Rev. No. / Date>

Description	Item	Takeoff Quantity	Total Cost/Unit	Total Amount
<i>A01120104 Public Address Systems</i>				
PA interface to telecom	1100	4.00 ea	7,421.53 /ea	29,686
Public address system, conventional, industrial	0200	100.00 spkr	880.98 /spkr	88,098
<i>A01120104 Public Address Systems</i>				<u>117,784</u>
Public Address System		100.00 spkr	1,177.84 /spkr	117,784
32740 Infill Grout at Door Truck Rail				
<i>A01040402 Hanger Doors</i>				
Epoxy Rail Grout (Five Star DP Epoxy Grout)	7950	750.00 cf	623.31 /cf	467,478
<i>A01040402 Hanger Doors</i>				<u>467,478</u>
Infill Grout at Door Truck Rail		1,000.00 LF	467.48 /LF	467,478
A Option A: Basic Re-Skinning, Maintain Existing		1.00 Is	40,718,984.57 /Is	40,718,985
Hangar Use				

DETAIL REPORT

Project: NASA Moffett Hangar 1
 Design Stage: Concept
 Project No.: 421240.01.40

Estimator: Edgerton, R
 Estimate No.: <Estimate Number>
 Rev #/Date: <Rev. No. / Date>

Description	Item	Takeoff Quantity	Total Cost/Unit	Total Amount
B Option B: Re-Skinning with Upgrades (Geotechnical, Structural and Slab				
0221 Study on the effect of soil improvements on the ground water contamina				
* unassigned *				
Study on the effect of soil improvements on the ground water contamination	---	1.00 ls	178,721.89 /ls	178,722
				178,722
* unassigned *				
Study on the effect of soil improvements on the ground water contamina		90,000.00 sf	1.99 /sf	178,722
0390 Clean & Patch Concrete				
<i>A01060101 Concrete Wall Finishes</i>				
Patching concrete, walls, epoxy grout, 1/2" deep, including chipping, cleaning and epoxy grout	2150	22,000.00 sf	46.85 /sf	1,030,777
				1,030,777
<i>A01060101 Concrete Wall Finishes</i>				
Clean & Patch Concrete		22,000.00 sf	46.85 /sf	1,030,777
05126 Seismic Safety Upgrades to Steel Structure				
<i>A01020201 Structural Frame</i>				
Bracing, angles, single or double, field fabricated	7625	70,000.00 lb	15.72 /lb	1,100,099
Bracing, add for shear tabs, clip angles, plates, stiffeners	7680	7,000.00 lb	2.90 /lb	20,275
Shop or field priming columns or column bracing, red oxide, 2 coats	8050	19,250.00 sf	0.90 /sf	17,377
				1,137,751
<i>A01020201 Structural Frame</i>				
Seismic Safety Upgrades to Steel Structure		77,000.00 lb	14.78 /lb	1,137,751
05300 Redwood Deck Substitution				
<i>A01020203 Roof Decks and Slabs</i>				
Rent crawler mounted, lattice boom crane, cable, 200 ton, 70' boom	1400	25.00 day	4,446.60 /day	111,165
Metal decking composite galv non-cellular 2" 20 ga	5300	196,180.00 sf	5.38 /sf	1,054,835
Sheet metal edge closure form, to 12", w/2 bends, 18 ga	7100	500.00 lf	8.18 /lf	4,091
				1,170,090
<i>A01020203 Roof Decks and Slabs</i>				
<i>A01030102 Insulation and Vapor Barrier</i>				
Vapor Retarders, building paper, asphalt felt sheathing paper, 15#	0400	196.18 sq	33.76 /sq	6,623
				6,623
<i>A01030102 Insulation and Vapor Barrier</i>				
<i>A01040101 Roof Covering</i>				
Rolling Mill Setup Fee	0500	1.00 ls	195,572.60 /ls	195,573
				195,573
<i>A01040101 Roof Covering</i>				
Redwood Deck Substitution		196,180.00 sf	7.00 /sf	1,372,286
05400 Pivot Pin Enclosure Rehab				
<i>A01160101 Substructure & Superstructure</i>				
Pivot Pin enclosure	0100	1.00 ls	35,144.38 /ls	35,144
				35,144
<i>A01160101 Substructure & Superstructure</i>				
Pivot Pin Enclosure Rehab			/unit	35,144
05517 Roof Walkway				
<i>A0102029X Other Roof Systems</i>				
Railing, industrial, welded, steel pipe, 2 rails, 3'-6" high, posts @ 5' O.C., 1-1/2" dia x 42" H, shop fabricated	0020	1,584.00 lf	56.65 /lf	89,740
Railing, industrial, welded, steel, shop fabricated, for 4" x 10 ga kick plate, add	0200	1,584.00 lf	8.98 /lf	14,216
Floor grating, steel, painted, 3/4" x 1/8" bearing bars @ 1-3/16" O.C., cross bars @ 2" O.C., over 300 S.F., field fabricated from panels	0464	2,376.00 sf	32.31 /sf	76,764
				180,721
<i>A0102029X Other Roof Systems</i>				
Roof Walkway		792.00 lf	228.18 /lf	180,721
07300 Main Bldg Corrugated Roofing/ExpJts/Hatch				
<i>A01040101 Roof Covering</i>				
Anchor "U" Clip	0100	81,146.00 ea	4.16 /ea	337,479
Anchor bolts, J-type, 5/16" diameter x 12" long, galvanized, includes nut and washer	2200	81,146.00 ea	16.00 /ea	1,298,679
Steel roofing panels, attached to steel frame, corrugated or ribbed, galvanized, 20 gauge	0400	543,350.00 sf	11.22 /sf	6,094,581
				7,730,738
<i>A01040101 Roof Covering</i>				
<i>A01040104 Flashing and Trim</i>				
Expansion joint, Copper Sheet 22ga x 24"	1900	1,080.00 lf	72.62 /lf	78,430
				78,430
<i>A01040104 Flashing and Trim</i>				
<i>A01040105 Roofing Openings & Supports</i>				
Roof Hatches, with curb, 1" fiberglass insulation, galvanized steel curb & cover, 2'-6" x 8'	1500	2.00 ea	2,804.61 /ea	5,609
				5,609
<i>A01040105 Roofing Openings & Supports</i>				
Main Bldg Corrugated Roofing/ExpJts/Hatch		543,350.00 sf	14.38 /sf	7,814,777
07600 Ridge Vent System Complete (manual ops)				
<i>A01040104 Flashing and Trim</i>				
Sheet metal flashing, stainless steel, flexible sheets, .018" thick, 26 gauge, including up to 4 bends	9100	4,400.00 sf	18.83 /sf	82,829
Coping, stainless steel, 26 ga., 16" wall	9985	2,200.00 lf	35.52 /lf	78,132
Drip edge, galvanized, mill finish, 8" wide	0500	2,200.00 lf	3.43 /lf	7,548
Ridge Vent	2300	1,100.00 lf	540.11 /lf	594,122
				762,632
<i>A01040104 Flashing and Trim</i>				
Ridge Vent System Complete (manual ops)		1.00 ls	762,631.57 /ls	762,632
07600 Clam Shell Door Flashing				
<i>A01040104 Flashing and Trim</i>				
Flashing, galvanized steel, .018", 26 ga.	0005	2,400.00 sf	47.55 /sf	114,128
Expansion joint, roof to wall joint with extruded aluminum cover	2500	2,200.00 lf	69.01 /lf	151,820
				265,948
<i>A01040104 Flashing and Trim</i>				
Clam Shell Door Flashing		2.00 ls	132,974.08 /ls	265,948
08100 Single Exterior Doors				
<i>A01030302 Solid Doors</i>				
Doors, fire, flush, "A" label, 3 hour, composite, 18 ga., 3'-0" x 7'-0"	0680	23.00 ea	1,430.27 /ea	32,896
Add for galvanizing, average cost per leaf	2025	23.00 leaf	65.57 /leaf	1,508
Add for baked enamel finish, average cost per leaf	2040	23.00 leaf	108.90 /leaf	2,505
Metal doors, rated, receive, sort and spread, per manhour	5000	11.50 mh	81.89 /mh	942
				37,851
<i>A01030302 Solid Doors</i>				
Single Exterior Doors		23.00 leaf	1,645.68 /leaf	37,851
08100 Double Leaf Exterior Doors				
<i>A01030302 Solid Doors</i>				

DETAIL REPORT

Project: NASA Moffett Hangar 1
 Design Stage: Concept
 Project No.: 421240.01.40

Estimator: Edgerton, R
 Estimate No.: <Estimate Number>
 Rev #/Date: <Rev. No. / Date>

Description	Item	Takeoff Quantity	Total Cost/Unit	Total Amount
A01030302 Solid Doors				
Doors, fire, flush, "A" label, 3 hour, composite, 18 ga., 3'-0" x 7'-0"	0680	2.00 ea	1,430.26 /ea	2,861
Add for galvanizing, average cost per leaf	2025	2.00 leaf	65.57 /leaf	131
Add for baked enamel finish, average cost per leaf	2040	2.00 leaf	108.90 /leaf	218
Metal doors, rated, receive, sort and spread, per manhour	5000	0.50 mh	81.86 /mh	41
				<u>3,250</u>
Double Leaf Exterior Doors		2.00 leaf	1,625.19 /leaf	3,250
08115 Single Leaf Exterior Frames				
<i>A01030302 Solid Doors</i>				
Frames, steel, knock down, hollow metal, for welded frames, add	4900	23.00 ea	112.41 /ea	2,585
Steel frames, KD, 14 ga, "A" or "B" label, to 5-3/4" throat, to 3'-0" x 7'-0"	5375	23.00 ea	478.55 /ea	11,007
Steel frames, add for baked enamel finish	6400	23.00 ea	55.58 /ea	1,278
Steel frames, add for galvanizing	6500	23.00 ea	21.08 /ea	485
Door frames, receive, sort and spread, per manhour	9090	11.50 mh	81.90 /mh	942
				<u>16,297</u>
Single Leaf Exterior Frames		23.00 ea	708.57 /ea	16,297
08115 Double Leaf Exterior Frame				
<i>A01030302 Solid Doors</i>				
Frames, steel, knock down, hollow metal, for welded frames, add	4900	1.00 ea	112.44 /ea	112
Steel frames, KD, 14 ga, "A" or "B" label, to 8-3/4" throat, to 3'-0" x 7'-0"	6175	1.00 ea	664.01 /ea	664
Steel frames, KD, 14 ga, "A" or "B" label, to 8-3/4" throat, to 6'-0" x 7'-0"	6220	1.00 ea	773.83 /ea	774
Steel frames, add for baked enamel finish	6400	1.00 ea	55.58 /ea	56
Steel frames, add for galvanizing	6500	1.00 ea	21.08 /ea	21
Door frames, receive, sort and spread, per manhour	9090	0.50 mh	81.88 /mh	41
				<u>1,668</u>
Double Leaf Exterior Frame		1.00 ea	1,667.88 /ea	1,668
08410 Roll-Up Utility Doors				
<i>A01040401 Overhead and Roll-up Doors</i>				
Doors, vertical coiling, motorized, steel, 14 gauge, 10' x 20', incl. frame and control panel	0100	12.00 ea	31,139.37 /ea	373,672
				<u>373,672</u>
Roll-Up Utility Doors		12.00 ea	31,139.37 /ea	373,672
08900 Corrugated Windows				
<i>A01030201 Windows</i>				
Corrugated Windows, Steel Frame	0100	42,780.00 sf	318.24 /sf	13,614,365
				<u>13,614,365</u>
Corrugated Windows		42,780.00 sf	318.24 /sf	13,614,365
08900 Flat Glass Windows				
<i>A01030201 Windows</i>				
Windows, steel, custom units, wire reinforced glass	2100	35,680.00 sf	77.07 /sf	2,749,845
				<u>2,749,845</u>
Flat Glass Windows		35,680.00 sf	77.07 /sf	2,749,845
09250 Interior Finishes				
<i>A01030102 Insulation and Vapor Barrier</i>				
Blanket insulation, for walls or ceilings, unfaced fiberglass, 3-1/2" thick, R13, 15" wide	0820	1,875.00 sf	1.17 /sf	2,195
				<u>2,195</u>
<i>A01030102 Insulation and Vapor Barrier</i>			/sf	2,195
<i>A01050401 Compartments, Cubicles and Toilet Partitions</i>				
Partitions, toilet, cubicles, ceiling hung, stainless steel	0500	20.00 ea	1,796.64 /ea	35,933
				<u>35,933</u>
<i>A01050401 Compartments, Cubicles and Toilet Partitions</i>			/ea	35,933
<i>A01060103 Gypsum Wallboard Finishes</i>				
3-5/8" Metal studs, galv, 20 ga., 16" oc, non load bearing, >10' ht.	2825	1,875.00 sf	3.59 /sf	6,740
Framing, 2x4 fire treated, trimmers/furring for door/window frames	4025	0.04 mbf	4,567.30 /mbf	183
18 to 16 ga x 1-1/2" channel bridging, studs 16" oc	6000	1.50 cdf	212.33 /cdf	319
Average cost, flate plate backing to 6" wide, 16 gauge	6022	30.00 lf	5.68 /lf	170
Studs, drive pins & studs, 1/4" & 3/8" diameter	6035	0.25 c	7.64 /c	2
Pack void between top track and flutes and seal both sides	7450	150.00 lf	6.97 /lf	1,046
Track gasketing, neoprene closed cell, 1/4" x 3/4"	7500	300.00 lf	5.48 /lf	1,643
Gypsum wallboard, on walls, fire resistant, taped & finished (level 4 finish), 5/8" thick	2150	3,750.00 sf	2.55 /sf	9,576
				<u>19,678</u>
<i>A01060103 Gypsum Wallboard Finishes</i>			/sf	19,678
<i>A01060201 Room Finishes</i>				
Interior Finishes	3000	1,000.00 sf	94.29 /sf	94,290
				<u>94,290</u>
<i>A01060201 Room Finishes</i>			/sf	94,290
Interior Finishes		1,875.00 unit	81.12 /unit	152,095
21310 Fire Sprinklers Toilet Rooms (1,000sf) and Utility Rooms (1,000sf)				
<i>A01080201 Pipes and Fittings</i>				
Pipe, fittings and valves, steel, black, grooved joint, 20" diameter, schedule 40, includes coupling & clevis type hanger 10' O.C.	1200	2.00 lf	539.29 /lf	1,079
Fire protection loops to 2.5" dia., including hangers & fittings	1225	1,100.00 sf	1.43 /sf	1,571
Sprinkler head distribution to 1.25" dia., including hangers/fittings	1250	1,100.00 sf	1.42 /sf	1,559
Backflow pvnt. OS&Y v.&4 1st cocks, rddc press, flg, iron, 6" pipe	5720	2.00 ea	10,423.18 /ea	20,846
				<u>25,065</u>
<i>A01080201 Pipes and Fittings</i>			/sf	25,065
<i>A01080202 Valves and Hydrants</i>				
Valves, iron body, swing check, flanged, 125 lb., 6"	6070	2.00 ea	2,567.55 /ea	5,135
				<u>5,135</u>
<i>A01080202 Valves and Hydrants</i>			/ea	5,135
<i>A01100201 Sprinkler Heads and Release Dev.</i>				
Pendant or upright heads, 135 deg to 286 deg F, 1/2" NPT, 1/2" orifice	3740	7.00 ea	84.43 /ea	591
Sprinkler System Components, valves, dry pipe air check type, 3" size	8000	1.00 ea	3,483.22 /ea	3,483
				<u>4,074</u>
<i>A01100201 Sprinkler Heads and Release Dev.</i>			/ea	4,074
<i>A01100301 Sprinkler Heads & System</i>				
Single standpipe connection (FHV or FDC), polished brass, 2-1/2" x 3"	7180	8.00 ea	647.33 /ea	5,179
2-way standpipe connection (FHV/FDC), polished brass, 2-1/2" x 2-1/2" x 6"	7330	2.00 ea	1,542.58 /ea	3,085
				<u>8,264</u>
<i>A01100301 Sprinkler Heads & System</i>			/ea	8,264
Fire Sprinklers Toilet Rooms (1,000sf) and Utility Rooms (1,000sf)		2,000.00 sf	21.26 /sf	42,528
21310 HEF Fire Suppression and Alarm at Hangar				
<i>A01100201 Sprinkler Heads and Release Dev.</i>				
HEF Fire Suppression & Fire Alarm Allowance, based on historical project data	----	200,000.00 sqft	35.74 /sqft	7,148,876

Description	Item	Takeoff Quantity	Total Cost/Unit	Total Amount
<i>A01100201 Sprinkler Heads and Release Dev.</i>				<u>7,148,876</u>
HEF Fire Suppression and Alarm at Hangar		200,000.00 sf	35.74 /sf	7,148,876
22405 Commercial Plumbing, Conceptual				
<i>A01080101 Waterclosets</i>				
Water closet, bowl only, w/ flush valve, seat, wall hung	3100	13.00 ea	1,173.79 /ea	15,259
Rough in water supply, waste & vent for wall hung water closet	3200	13.00 ea	2,597.30 /ea	33,765
Carriers/supports, water closet, siphon jet, horizontal, adjustable, caulk, single, 4" pipe size	7040	13.00 ea	1,618.25 /ea	21,037
<i>A01080101 Waterclosets</i>				<u>70,061</u>
<i>A01080102 Urinals</i>				
Urinal, wall hung, vitreous china, with hanger & self-closing valve, siphon jet type	3100	3.00 ea	1,201.10 /ea	3,603
Urinal, wall hung, rough-in, supply, waste and vent	3300	3.00 ea	1,682.04 /ea	5,046
Carriers/supports, urinal, wall mounted, plate type system	6300	3.00 ea	664.07 /ea	1,992
<i>A01080102 Urinals</i>				<u>10,642</u>
<i>A01080103 Lavatories</i>				
Lavatory, vanity top, vitreous china, white, single bowl, 20" x 16", includes trim	2900	6.00 ea	853.21 /ea	5,119
Lavatory, vanity top, rough-in, supply, waste and vent	3580	6.00 ea	1,460.17 /ea	8,761
Carriers/supports, lavatory, concealed arm, wall mounted, in stud or masonry, flat slab fixture	3700	6.00 ea	559.35 /ea	3,356
<i>A01080103 Lavatories</i>				<u>17,236</u>
<i>A01080104 Sinks</i>				
Service sink, faucet and drain, floor/corner mtd, 28"x28" PE on CI	6650	2.00 ea	2,030.43 /ea	4,061
Rough in water supply, waste & vent for floor mtd. service sinks	6790	2.00 ea	3,125.16 /ea	6,250
Fcts/f, flush valve, autmtc flush sensor and opertr for urinals wtrclsts	0972	6.00 ea	913.59 /ea	5,482
Faucets/fittings, lavatory faucet, automatic sensor and operator, with faucet head, residential	2810	6.00 ea	870.86 /ea	5,225
<i>A01080104 Sinks</i>				<u>21,018</u>
<i>A01080106 Drinking Fountains & Coolers</i>				
Carriers/supports, drinking fountain, wall mounted, plate type with studs, top back plate	0600	1.00 ea	289.14 /ea	289
Water cooler, wall mounted, non-recessed, dual height, 14.3 GPH	1040	1.00 ea	2,625.09 /ea	2,625
Water cooler, for supply, waste and vent, all coolers	9800	1.00 ea	973.22 /ea	973
<i>A01080106 Drinking Fountains & Coolers</i>				<u>3,887</u>
<i>A01080201 Pipes and Fittings</i>				
Cleanout, floor type, round or square, scoriated nickel bronze top, 3" pipe size	0120	12.00 ea	572.54 /ea	6,870
Cleanout tee, cast iron, B. & S., 4" pipe size, includes countersunk plug	0240	2.00 ea	870.61 /ea	1,741
3/4" copper type L w/ fittings & hangers 10' oc, wall hydrants	2450	100.00 lf	18.21 /lf	1,821
Water sply ms, dom/coml, brz, flgd, compound, 8" dia, to 1,800 GPM	2700	1.00 ea	22,857.77 /ea	22,858
Backflow pvnr, OS&Y v,&4 tst cocks, rddc press, fig, iron, 3" pipe	5680	1.00 ea	5,628.95 /ea	5,629
Hydrant, wall type, moderate climate, bronze, anti-siphon,encased, 1" I.P.S. connection	0300	4.00 ea	1,368.77 /ea	5,475
Hydrant, wall type, non-freeze, bronze, exposed, 3/4" I.P.S connection, 4" to 9" thick wall	1100	2.00 ea	835.91 /ea	1,672
<i>A01080201 Pipes and Fittings</i>				<u>46,066</u>
<i>A01080301 Waste Pipe and Fittings</i>				
6" Cast iron single hub w/ fittings, extra heavy, buried	5000	500.00 lf	75.59 /lf	37,796
Trench for buried waste or drain pipe, avg. 12" W, up to 24" D	6000	500.00 lf	2.90 /lf	1,448
Hand clean and trim trench for waste/drain lines	6010	500.00 lf	4.55 /lf	2,276
Backfill and compact piping trench, avg. 12" wide to, 24" deep	6015	500.00 lf	3.83 /lf	1,917
Bedding, sand, for waste/drain piping, to 6" deep	6025	9.26 cy	47.45 /cy	439
<i>A01080301 Waste Pipe and Fittings</i>				<u>43,877</u>
<i>A01080303 Floor Drains</i>				
Drain, floor, medium duty, cast iron, deep flange, 7" diameter top, 2" and 3" pipe size	2040	4.00 ea	460.61 /ea	1,842
Drain, floor, medium duty, cast iron, deep flange, 7" diameter top, for polished bronze top, add	2120	4.00 ea	166.41 /ea	666
Drain, floor, heavy duty with sediment bucket, cast iron, 12" diameter loose grate, 2", 3", 4", 5" and 6" pipe size	2420	2.00 ea	1,239.24 /ea	2,478
<i>A01080303 Floor Drains</i>				<u>4,987</u>
<i>A01080603 Interceptors</i>				
Interceptor, oil, fabricated steel, 100 GPM, 3" pipe size	4220	1.00 ea	22,492.91 /ea	22,493
<i>A01080603 Interceptors</i>				<u>22,493</u>
<i>A01090105 Hot Water Supply System (Cent Plant)</i>				
Comm1 water heater, 100 deg rise, elec, 50 gal., 9 kW, 37 GPH, 208V	4140	1.00 ea	6,735.13 /ea	6,735
<i>A01090105 Hot Water Supply System (Cent Plant)</i>				<u>6,735</u>
Commercial Plumbing, Conceptual		1,000.00 sf	247.00 /sf	247,002
23525 HVAC Restrooms & Electrical				
<i>A0109039X Other Cooling generating Systems</i>				
Fan coil A.C., direct expansion for use w/air cooled condensing unit, 5 ton cooling, includes filters and controls	1000	1.00 ea	3,131.76 /ea	3,132
<i>A0109039X Other Cooling generating Systems</i>				<u>3,132</u>
<i>A01090401 Air Distribution, Cooling and Heating</i>				
Rectangular galv steel duct w/ fittings & supports, garage exhaust	4000	495.00 lb	10.90 /lb	5,397
Exhaust fans, centrifugal, axial or v-belt, avg. cost per cfm	9700	1,500.00 cfm	0.82 /cfm	1,237
<i>A01090401 Air Distribution, Cooling and Heating</i>				<u>6,634</u>
<i>A01090601 HVAC Controls</i>				
Electric timeclock controls, shell equipment only	0010	1.00 ls	13,179.15 /ls	13,179
<i>A01090601 HVAC Controls</i>				<u>13,179</u>
<i>A01090702 Air Side Testing and Balancing-Heating, Cooling and Exhaust Systems</i>				
Test & balance, dryside	5000	8.00 hr	219.65 /hr	1,757
<i>A01090702 Air Side Testing and Balancing-Heating, Cooling and Exhaust Systems</i>				<u>1,757</u>
HVAC Restrooms & Electrical		1,500.00 sf	16.47 /sf	24,702
26022 Electrical Service, 1200A				
<i>A0110101 Main Transformers</i>				
Transformer, oil-filled, 15 kV with taps, 480 V secondary 3 phase, 1500 kVA, pad mounted	0600	4.00 ea	75,258.23 /ea	301,033

DETAIL REPORT

Project: NASA Moffett Hangar 1
 Design Stage: Concept
 Project No.: 421240.01.40

Estimator: Edgerton, R
 Estimate No.: <Estimate Number>
 Rev #/Date: <Rev. No. / Date>

Description	Item	Takeoff Quantity	Total Cost/Unit	Total Amount
A01110101 Main Transformers				
Transformer, dry-type, 3 phase 480 V primary 120/208 V secondary, 225 kVA	4300	12.00 ea	22,898.63 /ea	274,784
				575,816
A01110103 Main Switchboards				
Main switchboards,w/ disconnect & CB, 3P, 4W, avg cost per amp	6000	4,800.00 amp	48.31 /amp	231,863
Distribution switchboards,120/208v or 277/480v, avg cost per amp	2000	2,400.00 amp	41.05 /amp	98,523
				330,386
A01110105 Panels				
Panelboards, 3 phase 4 wire, main lugs, 120/208 V, 225 amp, 42 circuits, NQOD, incl 20 A 1 pole plug-in breakers	1000	24.00 ea	5,742.97 /ea	137,831
Panelboards, 3 phase 4 wire, main lugs, 277/480 V, 225 amp, 36 circuits, NEHB, incl 20 A 1 pole plug-in breakers	1450	24.00 ea	8,143.52 /ea	195,445
				333,276
A01110107 Motor Circuit Breakers				
Motor connections, flexible conduit and fittings, 3 phase, 230 volt, 25 HP motor	0200	4.00 ea	464.86 /ea	1,859
Motor starter, combination, with fused switch, size 1, 10 HP, NEMA 1	1600	4.00 ea	2,140.71 /ea	8,563
				10,422
A0111019X Service and Distribution				
Wire, copper, stranded, 600 volt, 600 kcmil, type XHHW, in raceway	3340	90.00 cdf	3,550.47 /cdf	319,542
Electrical Underground Ducts and Manholes, PVC, conduit with coupling, 4" diameter, schedule 40, installed by direct burial in slab or duct bank	1070	2,000.00 lf	23.03 /lf	46,052
Electrical Underground Ducts and Manholes, PVC, conduit with coupling, 6" diameter, schedule 40, installed by direct burial in slab or duct bank	1090	4,000.00 lf	42.49 /lf	169,955
Electrical Underground Ducts and Manholes, PVC, bell end and cap, 4" diameter, schedule 40, installed by direct burial in slab or duct bank	1370	40.00 ea	108.11 /ea	4,324
Electrical Underground Ducts and Manholes, PVC, bell end and cap, 6" diameter, schedule 40, installed by direct burial in slab or duct bank	1390	32.00 ea	160.12 /ea	5,124
Electrical Underground Ducts and Manholes, PVC, base spacer, 4" diameter, schedule 40, installed by direct burial in slab or duct bank	1470	400.00 ea	25.96 /ea	10,385
Electrical Underground Ducts and Manholes, PVC, base spacer, 6" diameter, schedule 40, installed by direct burial in slab or duct bank	1490	800.00 ea	32.12 /ea	25,698
				581,080
A01110201 Branch Wiring				
Cable terminations, indoor, insulation diameter range, 15 kV, .975" to 1.570", pad mount	0900	24.00 ea	475.00 /ea	11,400
Medium-cable single cable, copper, XLP shielding, ungrounded neutral, 15 kV, 1/0, in conduit, excl splicing & terminations	1800	70.00 cdf	1,256.94 /cdf	87,986
Switchboard instruments, 3 phase 4 wire, AC indicating, wattmeter	0300	4.00 ea	7,912.61 /ea	31,650
Switchboard instruments, ground fault protection, zero sequence	0600	4.00 ea	12,649.14 /ea	50,597
				181,633
Electrical Service, 1200A		4.00 svcs	503,153.39 /svcs	2,012,614
26024 Clam Shell Door Motors				
<i>A01040402 Hanger Doors</i>				
Motor connections, flexible conduit and fittings, 3 phase, 230 volt, 25 HP motor	0200	1.00 ea	464.87 /ea	465
Motor replacement, special fabrication to match existing on external	1600	1.00 ea	19,966.82 /ea	19,967
				20,432
Clam Shell Door Motors		1.00 ea	20,431.69 /ea	20,432
26024 Clam Shell Door Service				
<i>A01040402 Hanger Doors</i>				
Clam Shell Pivot Pins	0100	2.00 ea	38,187.36 /ea	76,375
Truck & Gear Box Service	0200	3.00 ea	4,097.73 /ea	12,293
Motor Service	1600	3.00 ea	6,355.28 /ea	19,066
				107,734
Clam Shell Door Service		3.00 ea	35,911.25 /ea	107,734
26024 400hz receipts				
<i>A01110107 Motor Circuit Breakers</i>				
400hz inverter	0220	4.00 ea	34,984.36 /ea	139,937
				139,937
<i>A0111019X Service and Distribution</i>				
Wire, copper, stranded, 600 volt, #8, type THWN-THHN, in raceway	1300	60.00 cdf	197.77 /cdf	11,866
				11,866
<i>A01110201 Branch Wiring</i>				
400hz receptacle	3980	20.00 ea	259.33 /ea	5,187
				5,187
<i>A01120201 General Construction Items</i>				
Aluminum conduit, 1" diameter, to 15' H, incl 2 terminations, 2 elbows & 11 beam clamps per 100 LF	0700	1,500.00 lf	21.29 /lf	31,940
Outlet boxes, cast, FDC, 2 gang, 3/4" hub	1820	20.00 ea	209.07 /ea	4,181
				36,122
400hz receipts		4.00 area	48,278.07 /area	193,112
26024 DC receipts				
<i>A01110107 Motor Circuit Breakers</i>				
DC rectifier	0220	4.00 ea	20,400.54 /ea	81,602
				81,602
<i>A0111019X Service and Distribution</i>				
Wire, copper, stranded, 600 volt, #8, type THWN-THHN, in raceway	1300	60.00 cdf	197.77 /cdf	11,866
				11,866
<i>A01110201 Branch Wiring</i>				
DC receptacle	3980	20.00 ea	259.33 /ea	5,187
				5,187
<i>A01120201 General Construction Items</i>				
Rigid galvanized steel conduit, 1" diameter, to 15' H, incl 2 terminations, 2 elbows & 11 beam clamps per 100 LF	1800	1,500.00 lf	23.60 /lf	35,405
Outlet boxes, cast, FDC, 2 gang, 3/4" hub	1820	20.00 ea	209.07 /ea	4,181
				39,586
DC receipts		4.00 area	34,560.31 /area	138,241

DETAIL REPORT

Project: NASA Moffett Hangar 1
 Design Stage: Concept
 Project No.: 421240.01.40

Estimator: Edgerton, R
 Estimate No.: <Estimate Number>
 Rev #/Date: <Rev. No. / Date>

Description	Item	Takeoff Quantity	Total Cost/Unit	Total Amount
26026 Metal Halide and HPS HI Bay Lighting				
<i>A0111019X Service and Distribution</i>				
Wire, copper, stranded, 600 volt, #8, type THWN-THHN, in raceway	1300	200.00 cfl	475.86 /cfl	95,172
				95,172
<i>A01110202 Lighting Equipment</i>				
High pressure sodium fixture, interior, recessed, square, 1000 W, incl lamps, and mounting hardware	0840	50.00 ea	3,906.50 /ea	195,325
Metal halide fixture, interior, vaporproof, pendent, 1000 W, incl lamps, and mounting hardware	3420	50.00 ea	5,181.51 /ea	259,075
				454,400
<i>A01120201 General Construction Items</i>				
Rigid galvanized steel conduit, 3/4" diameter, to 15' H, incl 2 terminations, 2 elbows & 11 beam clamps per 100 LF	1770	5,000.00 lf	54.56 /lf	272,795
				272,795
Metal Halide and HPS HI Bay Lighting		100.00 fixt	8,223.68 /fixt	822,368
26026 T8 Interior Lighting				
<i>A0111019X Service and Distribution</i>				
Wire, copper, stranded, 600 volt, #10, type THWN-THHN, in raceway	1250	50.00 cfl	146.36 /cfl	7,318
				7,318
<i>A01110202 Lighting Equipment</i>				
Fluorescent fixture, interior, strip, pendent mounted, industrial, white porcelain enamel, rs, 2-32 w t8, 4" incl lamps, mounting hardware and connections	3110	100.00 ea	328.88 /ea	32,888
				32,888
<i>A01120201 General Construction Items</i>				
Rigid galvanized steel conduit, 3/4" diameter, to 15' H, incl 2 terminations, 2 elbows & 11 beam clamps per 100 LF	1770	1,500.00 lf	18.71 /lf	28,062
				28,062
T8 Interior Lighting		100.00 fixt	682.68 /fixt	68,268
26026 Telecom Horizontal				
<i>A0112019X Other Communication & Alarm Systems</i>				
Unshielded twisted pair (UTP) cable, solid, plenum, #24, 4 pair, category 6	7242	300.00 cfl	286.03 /cfl	85,808
Unshielded twisted pair (UTP) jack, RJ-45, category 6	7316	200.00 ea	25.78 /ea	5,156
Voice/Data outlets, two jack opening, excl voice/data devices	0140	100.00 ea	27.60 /ea	2,760
				93,725
<i>A01120201 General Construction Items</i>				
Beam clamp and LV cable ring	5550	5,000.00 ea	30.58 /ea	152,912
				152,912
Telecom Horizontal		100.00 outl	2,466.36 /outl	246,636
26030 Receptacles				
<i>A0111019X Service and Distribution</i>				
Wire, copper, stranded, 600 volt, #10, type THWN-THHN, in raceway	1250	100.00 cfl	146.36 /cfl	14,636
				14,636
<i>A01110201 Branch Wiring</i>				
Duplex receptacle, ground fault interrupting, 20 amp	2482	80.00 ea	113.77 /ea	9,101
				9,101
<i>A01120201 General Construction Items</i>				
Rigid galvanized steel conduit, 3/4" diameter, to 15' H, incl 2 terminations, 2 elbows & 11 beam clamps per 100 LF	1770	3,200.00 lf	18.71 /lf	59,865
Outlet boxes, cast, weatherproof receptacle cover, 1 gang	1600	80.00 ea	32.09 /ea	2,567
Outlet boxes, cast, FSC, 1 gang, 3/4" hub	1760	80.00 ea	145.51 /ea	11,641
				74,073
Receptacles		80.00 rcpt	1,222.62 /rcpt	97,810
26710 Com Rooms				
<i>A01120103 Telephone Systems</i>				
Electrical Underground Ducts and Manholes, PVC, conduit with coupling, 4" diameter, schedule 40, installed by direct burial in slab or duct bank	1070	10,000.00 lf	23.03 /lf	230,260
Electrical underground ducts and manholes, hand holes, precast concrete, with concrete cover, 4'x4'x4" deep, excludes excavation, backfill and cast place concrete	1000	8.00 ea	4,228.71 /ea	33,830
				264,090
<i>A0112019X Other Communication & Alarm Systems</i>				
Com room rack allowance	3040	4.00 ea	11,880.03 /ea	47,520
Fiber optic connector	0300	96.00 ea	83.75 /ea	8,040
Fiber optics cable, outdoor, 62.5 microns, aerial/duct	1040	5,000.00 lf	3.00 /lf	14,976
				70,536
Com Rooms		4.00 ea	83,656.49 /ea	334,626
26712 Public Address System				
<i>A01120104 Public Address Systems</i>				
PA interface to telecom	1100	4.00 ea	7,421.54 /ea	29,686
Public address system, conventional, industrial	0200	100.00 spkr	880.98 /spkr	88,098
				117,784
Public Address System			/sf	117,784
31260 Underpinning & Soil Mixing				
<i>A01102023 Underpinning</i>				
Concrete pressure grouting, cement and sand, 1:1 mix, maximum	0100	28,274.40 cf	105.33 /cf	2,978,012
				2,978,012
Underpinning & Soil Mixing		240.00 ea	12,408.38 /ea	2,978,012
32740 Infill Grout at Door Truck Rail				
<i>A01040402 Hanger Doors</i>				
Epoxy Rail Grout (Five Star DP Epoxy Grout)	7950	750.00 cf	623.31 /cf	467,478
				467,478
Infill Grout at Door Truck Rail		1,000.00 LF	467.48 /LF	467,478
33630 Trench Floor Drains and Connections				
<i>A01080303 Floor Drains</i>				
Drain, trench, polyester polymer for cement concrete encasement, 12" internal width, with heavy duty galvanized grate	6770	2,200.00 lf	264.10 /lf	581,025

DETAIL REPORT

Project NASA Moffett Hangar 1
 Design Stage: Concept
 Project No.: 421240.01.40

Estimator: Edgerton, R
 Estimate No.: <Estimate Number>
 Rev #/Date: <Rev. No. / Date>

Description	Item	Takeoff Quantity	Total Cost/Unit	Total Amount
<i>A01080303 Floor Drains</i>				
Public Sanitary Utility Sewerage Piping, piping polyvinyl chloride pipe, B & S, 13' lengths, 12" diameter, SDR 35, excludes excavation or backfill	2160	500.00 lf	34.54 /lf	17,270
				598,295
<i>A01080303 Floor Drains</i>			/ea	
Trench Floor Drains and Connections		2,200.00 lf	271.95 /lf	598,295
				598,295
B Option B: Re-Skinning with Upgrades (Geotechnical, Structural and Slab		1.00 ls	45,394,318.56 /ls	45,394,319

DETAIL REPORT

Project: NASA Moffett Hangar 1
 Design Stage: Concept
 Project No.: 421240.01.40

Estimator: Edgerton, R
 Estimate No.: <Estimate Number>
 Rev #/Date: <Rev. No. / Date>

Description	Item	Takeoff Quantity	Total Cost/Unit	Total Amount
C Option C: Re-Skinning with Upgrades (Geotechnical, Structural and Slab				
0221 Study on the effect of soil improvements on the ground water contamina				
* unassigned *				
Study on the effect of soil improvements on the ground water contamination	---	1.00 ls	178,721.90 /ls	178,722
				178,722
* unassigned *				
Study on the effect of soil improvements on the ground water contamina		90,000.00 sf	1.99 /sf	178,722
0390 Clean & Patch Concrete				
<i>A01060101 Concrete Wall Finishes</i>				
Patching concrete, walls, epoxy grout, 1/2" deep, including chipping, cleaning and epoxy grout	2150	22,000.00 sf	46.85 /sf	1,030,777
				1,030,777
<i>A01060101 Concrete Wall Finishes</i>				
Clean & Patch Concrete		22,000.00 sf	46.85 /sf	1,030,777
05126 Seismic Safety Upgrades to Steel Structure				
<i>A01020201 Structural Frame</i>				
Bracing, angles, single or double, field fabricated	7625	70,000.00 lb	15.72 /lb	1,100,099
Bracing, add for shear tabs, clip angles, plates, stiffeners	7680	7,000.00 lb	2.90 /lb	20,275
Shop or field priming columns or column bracing, red oxide, 2 coats	8050	19,250.00 sf	0.90 /sf	17,377
				1,137,751
<i>A01020201 Structural Frame</i>				
Seismic Safety Upgrades to Steel Structure		77,000.00 lb	14.78 /lb	1,137,751
05300 Redwood Deck Substitution				
<i>A01020203 Roof Decks and Slabs</i>				
Rent crawler mounted, lattice boom crane, cable, 200 ton, 70' boom	1400	25.00 day	4,446.60 /day	111,165
Metal decking composite galv non-cellular 2" 20 ga	5300	196,180.00 sf	5.38 /sf	1,054,835
Sheet metal edge closure form, to 12", w/2 bends, 18 ga	7100	500.00 lf	8.18 /lf	4,091
				1,170,090
<i>A01020203 Roof Decks and Slabs</i>				
<i>A01030102 Insulation and Vapor Barrier</i>				
Vapor Retarders, building paper, asphalt felt sheathing paper, 15#	0400	196.18 sq	33.76 /sq	6,623
				6,623
<i>A01030102 Insulation and Vapor Barrier</i>				
<i>A01040101 Roof Covering</i>				
Rolling Mill Setup Fee	0500	1.00 ls	195,572.60 /ls	195,573
				195,573
<i>A01040101 Roof Covering</i>				
Redwood Deck Substitution		196,180.00 sf	7.00 /sf	1,372,286
05400 Pivot Pin Enclosure Rehab				
<i>A01160101 Substructure & Superstructure</i>				
Pivot Pin enclosure	0100	1.00 ls	35,144.38 /ls	35,144
				35,144
<i>A01160101 Substructure & Superstructure</i>				
Pivot Pin Enclosure Rehab			/unit	35,144
05517 Roof Walkway				
<i>A0102029X Other Roof Systems</i>				
Railing, industrial, welded, steel pipe, 2 rails, 3'-6" high, posts @ 5' O.C., 1-1/2" dia x 42" H, shop fabricated	0020	1,584.00 lf	56.65 /lf	89,740
Railing, industrial, welded, steel, shop fabricated, for 4' x 10 ga kick plate, add	0200	1,584.00 lf	8.98 /lf	14,216
Floor grating, steel, painted, 3/4" x 1/8" bearing bars @ 1-3/16" O.C., cross bars @ 2" O.C., over 300 S.F., field fabricated from panels	0464	2,376.00 sf	32.31 /sf	76,764
				180,721
<i>A0102029X Other Roof Systems</i>				
Roof Walkway		792.00 lf	228.18 /lf	180,721
07300 Main Bldg Corrugated Roofing/ExpJts/Hatch				
<i>A01040101 Roof Covering</i>				
Anchor "U" Clip	0100	81,146.00 ea	4.16 /ea	337,479
Anchor bolts, J-type, 5/16" diameter x 12" long, galvanized, includes nut and washer	2200	81,146.00 ea	16.00 /ea	1,298,679
Steel roofing panels, attached to steel frame, corrugated or ribbed, galvanized, 20 gauge	0400	543,350.00 sf	11.22 /sf	6,094,581
				7,730,739
<i>A01040101 Roof Covering</i>				
<i>A01040104 Flashing and Trim</i>				
Expansion joint, Copper Sheet 22ga x 24"	1900	1,080.00 lf	72.62 /lf	78,429
				78,429
<i>A01040104 Flashing and Trim</i>				
<i>A01040105 Roofing Openings & Supports</i>				
Roof Hatches, with curb, 1" fiberglass insulation, galvanized steel curb & cover, 2'-6" x 8'	1500	2.00 ea	2,804.62 /ea	5,609
				5,609
<i>A01040105 Roofing Openings & Supports</i>				
Main Bldg Corrugated Roofing/ExpJts/Hatch		543,350.00 sf	14.38 /sf	7,814,777
07600 Ridge Vent System Complete (manual ops)				
<i>A01040104 Flashing and Trim</i>				
Sheet metal flashing, stainless steel, flexible sheets, .018" thick, 26 gauge, including up to 4 bends	9100	4,400.00 sf	18.83 /sf	82,829
Coping, stainless steel, 26 ga., 16" wall	9985	2,200.00 lf	35.52 /lf	78,132
Drip edge, galvanized, mill finish, 8" wide	0500	2,200.00 lf	3.43 /lf	7,548
Ridge Vent	2300	1,100.00 lf	540.11 /lf	594,122
				762,632
<i>A01040104 Flashing and Trim</i>				
Ridge Vent System Complete (manual ops)		1.00 ls	762,631.56 /ls	762,632
07600 Clam Shell Door Flashing				
<i>A01040104 Flashing and Trim</i>				
Flashing, galvanized steel, .018", 26 ga.	0005	2,400.00 sf	47.55 /sf	114,128
Expansion joint, roof to wall joint with extruded aluminum cover	2500	2,200.00 lf	69.01 /lf	151,820
				265,948
<i>A01040104 Flashing and Trim</i>				
Clam Shell Door Flashing		2.00 ls	132,974.09 /ls	265,948
08100 Single Exterior Doors				
<i>A01030302 Solid Doors</i>				
Doors, fire, flush, "A" label, 3 hour, composite, 18 ga., 3'-0" x 7'-0"	0680	23.00 ea	1,430.27 /ea	32,896
Add for galvanizing, average cost per leaf	2025	23.00 leaf	65.57 /leaf	1,508
Add for baked enamel finish, average cost per leaf	2040	23.00 leaf	108.89 /leaf	2,505
Metal doors, rated, receive, sort and spread, per manhour	5000	11.50 mh	81.90 /mh	942
				37,851
<i>A01030302 Solid Doors</i>				
Single Exterior Doors		23.00 leaf	1,645.68 /leaf	37,851
08100 Double Leaf Exterior Doors				
<i>A01030302 Solid Doors</i>				

DETAIL REPORT

Project: NASA Moffett Hangar 1
 Design Stage: Concept
 Project No.: 421240.01.40

Estimator: Edgerton, R
 Estimate No.: <Estimate Number>
 Rev #/Date: <Rev. No. / Date>

Description	Item	Takeoff Quantity	Total Cost/Unit	Total Amount
A01030302 Solid Doors				
Doors, fire, flush, "A" label, 3 hour, composite, 18 ga., 3'-0" x 7'-0"	0680	2.00 ea	1,430.28 /ea	2,861
Add for galvanizing, average cost per leaf	2025	2.00 leaf	65.56 /leaf	131
Add for baked enamel finish, average cost per leaf	2040	2.00 leaf	108.89 /leaf	218
Metal doors, rated, receive, sort and spread, per manhour	5000	0.50 mh	81.90 /mh	41
				<u>3,250</u>
Double Leaf Exterior Doors		2.00 leaf	1,625.20 /leaf	3,250
08115 Single Leaf Exterior Frames				
<i>A01030302 Solid Doors</i>				
Frames, steel, knock down, hollow metal, for welded frames, add	4900	23.00 ea	112.41 /ea	2,585
Steel frames, KD, 14 ga, "A" or "B" label, to 5-3/4" throat, to 3'-0" x 7'-0"	5375	23.00 ea	478.55 /ea	11,007
Steel frames, add for baked enamel finish	6400	23.00 ea	55.58 /ea	1,278
Steel frames, add for galvanizing	6500	23.00 ea	21.08 /ea	485
Door frames, receive, sort and spread, per manhour	9090	11.50 mh	81.89 /mh	942
				<u>16,297</u>
Single Leaf Exterior Frames		23.00 ea	708.57 /ea	16,297
08115 Double Leaf Exterior Frame				
<i>A01030302 Solid Doors</i>				
Frames, steel, knock down, hollow metal, for welded frames, add	4900	1.00 ea	112.41 /ea	112
Steel frames, KD, 14 ga, "A" or "B" label, to 8-3/4" throat, to 3'-0" x 7'-0"	6175	1.00 ea	664.03 /ea	664
Steel frames, KD, 14 ga, "A" or "B" label, to 8-3/4" throat, to 6'-0" x 7'-0"	6220	1.00 ea	773.82 /ea	774
Steel frames, add for baked enamel finish	6400	1.00 ea	55.57 /ea	56
Steel frames, add for galvanizing	6500	1.00 ea	21.08 /ea	21
Door frames, receive, sort and spread, per manhour	9090	0.50 mh	81.88 /mh	41
				<u>1,668</u>
Double Leaf Exterior Frame		1.00 ea	1,667.85 /ea	1,668
08410 Roll-Up Utility Doors				
<i>A01040401 Overhead and Roll-up Doors</i>				
Doors, vertical coiling, motorized, steel, 14 gauge, 10' x 20', incl. frame and control panel	0100	12.00 ea	31,139.37 /ea	373,672
				<u>373,672</u>
Roll-Up Utility Doors		12.00 ea	31,139.37 /ea	373,672
08900 Corrugated Windows				
<i>A01030201 Windows</i>				
Corrugated Windows, Steel Frame	0100	42,780.00 sf	318.24 /sf	13,614,365
				<u>13,614,365</u>
Corrugated Windows		42,780.00 sf	318.24 /sf	13,614,365
08900 Flat Glass Windows				
<i>A01030201 Windows</i>				
Windows, steel, custom units, wire reinforced glass	2100	35,680.00 sf	77.07 /sf	2,749,845
				<u>2,749,845</u>
Flat Glass Windows		35,680.00 sf	77.07 /sf	2,749,845
09250 Interior Finishes				
<i>A01030102 Insulation and Vapor Barrier</i>				
Blanket insulation, for walls or ceilings, unfaced fiberglass, 3-1/2" thick, R13, 15" wide	0820	1,875.00 sf	1.17 /sf	2,195
				<u>2,195</u>
Interior Finishes				2,195
<i>A01050401 Compartments, Cubicles and Toilet Partitions</i>				
Partitions, toilet, cubicles, ceiling hung, stainless steel	0500	20.00 ea	1,796.64 /ea	35,933
				<u>35,933</u>
Interior Finishes				35,933
<i>A01060103 Gypsum Wallboard Finishes</i>				
3-5/8" Metal studs, galv, 20 ga., 16" oc, non load bearing, >10' ht.	2825	1,875.00 sf	3.59 /sf	6,740
Framing, 2x4 fire treated, trimmers/furring for door/window frames	4025	0.04 mbf	4,567.80 /mbf	183
18 to 16 ga x 1-1/2" channel bridging, studs 16" oc	6000	1.50 cdf	212.33 /cdf	318
Average cost, flate plate backing to 6" wide, 16 gauge	6022	3.00 lf	5.68 /lf	170
Studs, drive pins & studs, 1/4" & 3/8" diameter	6035	0.25 c	7.80 /c	2
Pack void between top track and flutes and seal both sides	7450	150.00 lf	6.97 /lf	1,046
Track gasketing, neoprene closed cell, 1/4" x 3/4"	7500	300.00 lf	5.48 /lf	1,643
Gypsum wallboard, on walls, fire resistant, taped & finished (level 4 finish), 5/8" thick	2150	3,750.00 sf	2.55 /sf	9,576
				<u>19,678</u>
Interior Finishes				19,678
<i>A01060201 Room Finishes</i>				
Interior Finishes	3000	1,000.00 sf	94.29 /sf	94,290
				<u>94,290</u>
Interior Finishes		1,875.00 unit	81.12 /unit	152,095
21310 Fire Sprinklers Toilet Rooms (1,000sf) and Utility Rooms (1,000sf)				
<i>A01080201 Pipes and Fittings</i>				
Pipe, fittings and valves, steel, black, grooved joint, 20" diameter, schedule 40, includes coupling & clevis type hanger 10' O.C.	1200	2.00 lf	539.30 /lf	1,079
Fire protection loops to 2.5" dia., including hangers & fittings	1225	1,100.00 sf	1.43 /sf	1,571
Sprinkler head distribution to 1.25" dia., including hangers/fittings	1250	1,100.00 sf	1.42 /sf	1,559
Backflow pvnt. OS&Y v.&4 1st cocks, rddc press, fig, iron, 6" pipe	5720	2.00 ea	10,423.20 /ea	20,846
				<u>25,055</u>
Pipes and Fittings				25,055
<i>A01080202 Valves and Hydrants</i>				
Valves, iron body, swing check, flanged, 125 lb., 6"	6070	2.00 ea	2,567.55 /ea	5,135
				<u>5,135</u>
Valves and Hydrants				5,135
<i>A01100201 Sprinkler Heads and Release Dev.</i>				
Pendant or upright heads, 135 deg to 286 deg F, 1/2" NPT, 1/2" orifice	3740	7.00 ea	84.43 /ea	591
Sprinkler System Components, valves, dry pipe air check type, 3" size	8000	1.00 ea	3,483.17 /ea	3,483
				<u>4,074</u>
Sprinkler Heads and System				4,074
<i>A01100301 Sprinkler Heads & System</i>				
Single standpipe connection (FHV or FDC), polished brass, 2-1/2" x 3"	7180	8.00 ea	647.34 /ea	5,179
2-way standpipe connection (FHV/FDC), polshd brass, 2-1/2" x 2-1/2" x 6"	7330	2.00 ea	1,542.57 /ea	3,085
				<u>8,264</u>
Sprinkler Heads & System				8,264
Fire Sprinklers Toilet Rooms (1,000sf) and Utility Rooms (1,000sf)		2,000.00 sf	21.26 /sf	42,528
21310 HEF Fire Suppression and Alarm at Hangar				
<i>A01100201 Sprinkler Heads and Release Dev.</i>				
HEF Fire Suppression & Fire Alarm Allowance, based on historical project data	----	200,000.00 sqft	35.74 /sqft	7,148,876

DETAIL REPORT

Project: NASA Moffett Hangar 1
 Design Stage: Concept
 Project No.: 421240.01.40

Estimator: Edgerton, R
 Estimate No.: <Estimate Number>
 Rev #/Date: <Rev. No. / Date>

Description	Item	Takeoff Quantity	Total Cost/Unit	Total Amount
<i>A01100201 Sprinkler Heads and Release Dev.</i>				<i>7,148,876</i>
HEF Fire Suppression and Alarm at Hangar		200,000.00 sf	35.74 /sf	7,148,876
22405 Commercial Plumbing, Conceptual				
<i>A01080101 Waterclosets</i>				
Water closet, bowl only, w/ flush valve, seat, wall hung	3100	13.00 ea	1,173.80 /ea	15,259
Rough in water supply, waste & vent for wall hung water closet	3200	13.00 ea	2,597.30 /ea	33,765
Carriers/supports, water closet, siphon jet, horizontal, adjustable, caulk, single, 4" pipe size	7040	13.00 ea	1,618.25 /ea	21,037
<i>A01080101 Waterclosets</i>				<i>70,062</i>
<i>A01080102 Urinals</i>				
Urinal, wall hung, vitreous china, with hanger & self-closing valve, siphon jet type	3100	3.00 ea	1,201.10 /ea	3,603
Urinal, wall hung, rough-in, supply, waste and vent	3300	3.00 ea	1,682.05 /ea	5,046
Carriers/supports, urinal, wall mounted, plate type system	6300	3.00 ea	664.05 /ea	1,992
<i>A01080102 Urinals</i>				<i>10,642</i>
<i>A01080103 Lavatories</i>				
Lavatory, vanity top, vitreous china, white, single bowl, 20" x 16", includes trim	2900	6.00 ea	853.21 /ea	5,119
Lavatory, vanity top, rough-in, supply, waste and vent	3580	6.00 ea	1,460.17 /ea	8,761
Carriers/supports, lavatory, concealed arm, wall mounted, in stud or masonry, flat slab fixture	3700	6.00 ea	559.36 /ea	3,356
<i>A01080103 Lavatories</i>				<i>17,236</i>
<i>A01080104 Sinks</i>				
Service sink, faucet and drain, floor/corner mtd, 28"x28" PE on CI	6650	2.00 ea	2,030.43 /ea	4,061
Rough in water supply, waste & vent for floor mtd. service sinks	6790	2.00 ea	3,125.15 /ea	6,250
Fcts/f, flush valve, autmtc flush sensor and opertr for urinals wtrclsts	0972	6.00 ea	913.59 /ea	5,482
Faucets/fittings, lavatory faucet, automatic sensor and operator, with faucet head, residential	2810	6.00 ea	870.87 /ea	5,225
<i>A01080104 Sinks</i>				<i>21,018</i>
<i>A01080106 Drinking Fountains & Coolers</i>				
Carriers/supports, drinking fountain, wall mounted, plate type with studs, top back plate	0600	1.00 ea	289.15 /ea	289
Water cooler, wall mounted, non-recessed, dual height, 14.3 GPH	1040	1.00 ea	2,625.11 /ea	2,625
Water cooler, for supply, waste and vent, all coolers	9800	1.00 ea	973.19 /ea	973
<i>A01080106 Drinking Fountains & Coolers</i>				<i>3,887</i>
<i>A01080201 Pipes and Fittings</i>				
Cleanout, floor type, round or square, scoriated nickel bronze top, 3" pipe size	0120	12.00 ea	572.54 /ea	6,870
Cleanout tee, cast iron, B. & S., 4" pipe size, includes countersunk plug	0240	2.00 ea	870.61 /ea	1,741
3/4" copper type L w/ fittings & hangers 10' oc, wall hydrants	2450	100.00 lf	18.21 /lf	1,821
Water sply ms, dom/coml, brz, flgd, compound, 8" dia, to 1,800 GPM	2700	1.00 ea	22,857.77 /ea	22,858
Backflow pvnr, OS&Y v,&4 tst cocks, rddc press, fig, iron, 3" pipe	5680	1.00 ea	5,628.94 /ea	5,629
Hydrant, wall type, moderate climate, bronze, anti-siphon,encased, 1" I.P.S. connection	0300	4.00 ea	1,368.77 /ea	5,475
Hydrant, wall type, non-freeze, bronze, exposed, 3/4" I.P.S connection, 4" to 9" thick wall	1100	2.00 ea	835.90 /ea	1,672
<i>A01080201 Pipes and Fittings</i>				<i>46,066</i>
<i>A01080301 Waste Pipe and Fittings</i>				
6" Cast iron single hub w/ fittings, extra heavy, buried	5000	500.00 lf	75.59 /lf	37,796
Trench for buried waste or drain pipe, avg. 12" W, up to 24" D	6000	500.00 lf	2.90 /lf	1,448
Hand clean and trim trench for waste/drain lines	6010	500.00 lf	4.55 /lf	2,276
Backfill and compact piping trench, avg. 12" wide to, 24" deep	6015	500.00 lf	3.83 /lf	1,917
Bedding, sand, for waste/drain piping, to 6" deep	6025	9.26 cy	47.45 /cy	439
<i>A01080301 Waste Pipe and Fittings</i>				<i>43,877</i>
<i>A01080303 Floor Drains</i>				
Drain, floor, medium duty, cast iron, deep flange, 7" diameter top, 2" and 3" pipe size	2040	4.00 ea	460.61 /ea	1,842
Drain, floor, medium duty, cast iron, deep flange, 7" diameter top, for polished bronze top, add	2120	4.00 ea	166.41 /ea	666
Drain, floor, heavy duty with sediment bucket, cast iron, 12" diameter loose grate, 2", 3", 4", 5" and 6" pipe size	2420	2.00 ea	1,239.23 /ea	2,478
<i>A01080303 Floor Drains</i>				<i>4,987</i>
<i>A01080603 Interceptors</i>				
Interceptor, oil, fabricated steel, 100 GPM, 3" pipe size	4220	1.00 ea	22,492.91 /ea	22,493
<i>A01080603 Interceptors</i>				<i>22,493</i>
<i>A01090105 Hot Water Supply System (Cent Plant)</i>				
Comm1 water heater, 100 deg rise, elec, 50 gal., 9 kW, 37 GPH, 208V	4140	1.00 ea	6,735.14 /ea	6,735
<i>A01090105 Hot Water Supply System (Cent Plant)</i>				<i>6,735</i>
Commercial Plumbing, Conceptual		1,000.00 sf	247.00 /sf	247,002
26022 Electrical Service, 1200A				
<i>A01110101 Main Transformers</i>				
Transformer, oil-filled, 15 kV with taps, 480 V secondary 3 phase, 1500 kVA, pad mounted	0600	4.00 ea	75,258.23 /ea	301,033
Transformer, dry-type, 3 phase 480 V primary 120/208 V secondary, 225 kVA	4300	12.00 ea	22,898.63 /ea	274,784
<i>A01110101 Main Transformers</i>				<i>575,816</i>
<i>A01110103 Main Switchboards</i>				
Main switchboards,w/ disconnect & CB, 3P, 4W, avg cost per amp	6000	4,800.00 amp	48.31 /amp	231,863
Distribution switchboards,120/208v or 277/480v, avg cost per amp	2000	2,400.00 amp	41.05 /amp	98,523
<i>A01110103 Main Switchboards</i>				<i>330,386</i>
<i>A01110105 Panels</i>				
Panelboards, 3 phase 4 wire, main lugs, 120/208 V, 225 amp, 42 circuits, NQOD, incl 20 A 1 pole plug-in breakers	1000	24.00 ea	5,742.97 /ea	137,831
Panelboards, 3 phase 4 wire, main lugs, 277/480 V, 225 amp, 36 circuits, NEHB, incl 20 A 1 pole plug-in breakers	1450	24.00 ea	8,143.52 /ea	195,445
<i>A01110105 Panels</i>				<i>333,276</i>
<i>A01110107 Motor Circuit Breakers</i>				
Motor connections, flexible conduit and fittings, 3 phase, 230 volt, 25 HP motor	0200	4.00 ea	464.86 /ea	1,859
Motor starter, combination, with fused switch, size 1, 10 HP, NEMA 1	1600	4.00 ea	2,140.71 /ea	8,563

DETAIL REPORT

Project: NASA Moffett Hangar 1
 Design Stage: Concept
 Project No.: 421240.01.40

Estimator: Edgerton, R
 Estimate No.: <Estimate Number>
 Rev #/Date: <Rev. No. / Date>

Description	Item	Takeoff Quantity	Total Cost/Unit	Total Amount
A01110107 Motor Circuit Breakers				
			/ea	10,422
A0111019X Service and Distribution				
Wire, copper, stranded, 600 volt, 600 kcmil, type XHHW, in raceway	3340	90.00 clf	3,550.47 /clf	319,542
Electrical Underground Ducts and Manholes, PVC, conduit with coupling, 4" diameter, schedule 40, installed by direct burial in slab or duct bank	1070	2,000.00 lf	23.03 /lf	46,052
Electrical Underground Ducts and Manholes, PVC, conduit with coupling, 6" diameter, schedule 40, installed by direct burial in slab or duct bank	1090	4,000.00 lf	42.49 /lf	169,955
Electrical Underground Ducts and Manholes, PVC, bell end and cap, 4" diameter, schedule 40, installed by direct burial in slab or duct bank	1370	40.00 ea	108.11 /ea	4,324
Electrical Underground Ducts and Manholes, PVC, bell end and cap, 6" diameter, schedule 40, installed by direct burial in slab or duct bank	1390	32.00 ea	160.12 /ea	5,124
Electrical Underground Ducts and Manholes, PVC, base spacer, 4" diameter, schedule 40, installed by direct burial in slab or duct bank	1470	400.00 ea	25.96 /ea	10,385
Electrical Underground Ducts and Manholes, PVC, base spacer, 6" diameter, schedule 40, installed by direct burial in slab or duct bank	1490	800.00 ea	32.12 /ea	25,698
				<u>581,080</u>
A01110201 Branch Wiring				
Cable terminations, indoor, insulation diameter range, 15 kv, .975" to 1.570", pad mount	0900	24.00 ea	475.00 /ea	11,400
Medium-cable single cable, copper, XLP shielding, ungrounded neutral, 15 kv, 1/0, in conduit, excl splicing & terminations	1800	70.00 clf	1,256.94 /clf	87,986
Switchboard instruments, 3 phase 4 wire, AC indicating, wattmeter	0300	4.00 ea	7,912.61 /ea	31,650
Switchboard instruments, ground fault protection, zero sequence	0600	4.00 ea	12,649.14 /ea	50,597
				<u>181,633</u>
Electrical Service, 1200A		4.00 svcs	503,153.39 /svcs	2,012,614
26024 Clam Shell Door Motors				
A01040402 Hanger Doors				
Motor connections, flexible conduit and fittings, 3 phase, 230 volt, 25 HP motor	0200	1.00 ea	464.86 /ea	465
Motor replacement, special fabrication to match existing on external	1600	1.00 ea	19,966.83 /ea	19,967
				<u>20,432</u>
Clam Shell Door Motors		1.00 ea	20,431.69 /ea	20,432
26024 Clam Shell Door Service				
A01040402 Hanger Doors				
Clam Shell Door Pivot Pin	0100	2.00 ea	37,091.73 /ea	74,183
Truck & Gear Box Service	0200	3.00 ea	4,097.72 /ea	12,293
Motor Service	1600	3.00 ea	6,355.30 /ea	19,066
				<u>105,543</u>
Clam Shell Door Service		4.00 ea	26,385.63 /ea	105,543
26024 400hz recepts				
A01110107 Motor Circuit Breakers				
400hz inverter	0220	4.00 ea	34,984.36 /ea	139,937
				<u>139,937</u>
A0111019X Service and Distribution				
Wire, copper, stranded, 600 volt, #8, type THWN-THHN, in raceway	1300	60.00 clf	197.77 /clf	11,866
				<u>11,866</u>
A01110201 Branch Wiring				
400hz receptacle	3980	20.00 ea	259.33 /ea	5,187
				<u>5,187</u>
A01120201 General Construction Items				
Aluminum conduit, 1" diameter, to 15' H, incl 2 terminations, 2 elbows & 11 beam clamps per 100 LF	0700	1,500.00 lf	21.29 /lf	31,940
Outlet boxes, cast, FDC, 2 gang, 3/4" hub	1820	20.00 ea	209.07 /ea	4,181
				<u>36,122</u>
400hz recepts		4.00 area	48,278.06 /area	193,112
26024 DC recepts				
A01110107 Motor Circuit Breakers				
DC rectifier	0220	4.00 ea	20,400.54 /ea	81,602
				<u>81,602</u>
A0111019X Service and Distribution				
Wire, copper, stranded, 600 volt, #8, type THWN-THHN, in raceway	1300	60.00 clf	197.77 /clf	11,866
				<u>11,866</u>
A01110201 Branch Wiring				
DC receptacle	3980	20.00 ea	259.33 /ea	5,187
				<u>5,187</u>
A01120201 General Construction Items				
Rigid galvanized steel conduit, 1" diameter, to 15' H, incl 2 terminations, 2 elbows & 11 beam clamps per 100 LF	1800	1,500.00 lf	23.60 /lf	35,405
Outlet boxes, cast, FDC, 2 gang, 3/4" hub	1820	20.00 ea	209.07 /ea	4,181
				<u>39,586</u>
DC recepts		4.00 area	34,560.31 /area	138,241
26026 Metal Halide and HPS Hi Bay Lighting				
A0111019X Service and Distribution				
Wire, copper, stranded, 600 volt, #8, type THWN-THHN, in raceway	1300	200.00 clf	475.86 /clf	95,172
				<u>95,172</u>
A01110202 Lighting Equipment				
High pressure sodium fixture, interior, recessed, square, 1000 W, incl lamps, and mounting hardware	0840	50.00 ea	3,906.50 /ea	195,325
Metal halide fixture, interior, vaporproof, pendant, 1000 W, incl lamps, and mounting hardware	3420	50.00 ea	5,181.50 /ea	259,075
				<u>454,400</u>
A01120201 General Construction Items				
Rigid galvanized steel conduit, 3/4" diameter, to 15' H, incl 2 terminations, 2 elbows & 11 beam clamps per 100 LF	1770	5,000.00 lf	54.56 /lf	272,795
				<u>272,795</u>
Metal Halide and HPS Hi Bay Lighting		100.00 fixt	8,223.68 /fixt	822,368
26026 T8 interior lighting				
A0111019X Service and Distribution				
Wire, copper, stranded, 600 volt, #10, type THWN-THHN, in raceway	1250	50.00 clf	146.36 /clf	7,318

DETAIL REPORT

Project: NASA Moffett Hangar 1
 Design Stage: Concept
 Project No.: 421240.01.40

Estimator: Edgerton, R
 Estimate No.: <Estimate Number>
 Rev #/Date: <Rev. No. / Date>

Description	Item	Takeoff Quantity	Total Cost/Unit	Total Amount
A0111019X Service and Distribution				
			/fs	7,318
A01110202 Lighting Equipment				
Fluorescent fixture,interior,strip,pendent mounted,industrial,white porcelain enamel,rs, 2-32 w t8,41,incl lamps,mounting hardware and connections	3110	100.00 ea	328.88 /ea	32,888
A01110202 Lighting Equipment				
			/fs	32,888
A01120201 General Construction Items				
Rigid galvanized steel conduit, 3/4" diameter, to 15' H, incl 2 terminations, 2 elbows & 11 beam clamps per 100 LF	1770	1,500.00 lf	18.71 /lf	28,062
A01120201 General Construction Items				
T8 interior lighting		100.00 fixt	682.68 /fixt	68,268
26026 Telecom horizontal				
A0112019X Other Communication & Alarm Systems				
Unshielded twisted pair (UTP) cable, solid, plenum, #24, 4 pair, category 6	7242	300.00 clf	286.03 /clf	85,808
Unshielded twisted pair (UTP) jack, RJ-45, category 6	7316	200.00 ea	25.78 /ea	5,156
Voice/Data outlets, two jack opening, excl voice/data devices	0140	100.00 ea	27.60 /ea	2,760
A0112019X Other Communication & Alarm Systems				
			/fs	93,725
A01120201 General Construction Items				
Beam clamp and LV cable ring	5550	5,000.00 ea	30.58 /ea	152,912
A01120201 General Construction Items				
Telecom horizontal		100.00 outl	2,466.36 /outl	246,636
26030 Receptacles				
A01110201 Branch Wiring				
Wire, copper, stranded, 600 volt, #10, type THWN-THHN, in raceway	1250	100.00 clf	146.36 /clf	14,636
Duplex receptacle, ground fault interrupting, 20 amp	2482	80.00 ea	113.77 /ea	9,101
A01110201 Branch Wiring				
			/sf	23,737
A01120201 General Construction Items				
Rigid galvanized steel conduit, 3/4" diameter, to 15' H, incl 2 terminations, 2 elbows & 11 beam clamps per 100 LF	1770	3,200.00 lf	18.71 /lf	59,865
Outlet boxes, cast, weatherproof receptacle cover, 1 gang	1600	80.00 ea	32.09 /ea	2,567
Outlet boxes, cast, FSC, 1 gang, 3/4" hub	1760	80.00 ea	145.51 /ea	11,641
A01120201 General Construction Items				
Receptacles		80.00 rcpt	1,222.62 /rcpt	97,810
26710 Com rooms				
A01120103 Telephone Systems				
Electrical Underground Ducts and Manholes, PVC, conduit with coupling, 4" diameter, schedule 40, installed by direct burial in slab or duct bank	1070	10,000.00 lf	23.03 /lf	230,260
Electrcl undgrnd ducts and manholes,hand holes,precast concrete,with concrete cover,4'x4'x4'deep,excludes excavation,backfill and cast place concrete	1000	8.00 ea	4,228.71 /ea	33,830
A01120103 Telephone Systems				
			/fs	264,090
A0112019X Other Communication & Alarm Systems				
Com room rack allowance	3040	4.00 ea	11,880.03 /ea	47,520
Fiber optic connector	0300	96.00 ea	83.75 /ea	8,040
Fiber optics cable, outdoor, 62.5 microns, aerial/duct	1040	5,000.00 lf	3.00 /lf	14,976
A0112019X Other Communication & Alarm Systems				
			/fs	70,536
Com rooms		4.00 ea	83,656.50 /ea	334,626
26712 Public Address System				
A01120104 Public Address Systems				
PA interface to telecom	1100	4.00 ea	7,421.53 /ea	29,686
Public address system, conventional, industrial	0200	100.00 spkr	880.98 /spkr	88,098
A01120104 Public Address Systems				
			/sf	117,784
Public Address System				117,784
31260 Underpinning & Soil Mixing				
A01010203 Underpinning				
Concrete pressure grouting, cement and sand, 1:1 mix, maximum	0100	28,274.40 cf	105.33 /cf	2,978,019
A01010203 Underpinning				
			/ea	2,978,019
Underpinning & Soil Mixing		240.00 ea	12,408.41 /ea	2,978,019
32740 Infill Grout at Door Truck Rail				
A01040402 Hanger Doors				
Epoxy Rail Grout (Five Star DP Epoxy Grout)	7950	750.00 cf	623.31 /cf	467,478
A01040402 Hanger Doors				
			/ea	467,478
Infill Grout at Door Truck Rail		1,000.00 LF	467.48 /LF	467,478
33630 Trench Floor Drains and Connections				
A01080303 Floor Drains				
Drain, trench, polyester polymer for cement concrete encasement, 12" internal width, with heavy duty galvanized grate	6770	2,200.00 lf	264.10 /lf	581,025
Public Sanitary Utility Sewerage Piping, piping polyvinyl chloride pipe, B & S, 13' lengths, 12" diameter, SDR 35, excludes excavation or backfill	2160	500.00 lf	34.54 /lf	17,270
A01080303 Floor Drains				
			/ea	598,295
Trench Floor Drains and Connections		2,200.00 lf	271.95 /lf	598,295
C Option C: Re-Skinning with Upgrades (Geotechnical, Structural and Slab		1.00 ls	45,367,433.45 /ls	45,367,433

DETAIL REPORT

Project: NASA Moffett Hangar 1
 Design Stage: Concept
 Project No.: 421240.01.40

Estimator: Edgerton, R
 Estimate No.: <Estimate Number>
 Rev #/Date: <Rev. No. / Date>

Description	Item	Takeoff Quantity	Total Cost/Unit	Total Amount
D Option D: Adaptive Re-Use, Re-Skinning with Upgrades (Geotechnical, St				
0221 Study on the effect of soil improvements on the ground water contamina				
* unassigned *				
Study on the effect of soil improvements on the ground water contamination	---	1.00 ls	178,721.90 /ls	178,722
				178,722
* unassigned *				
Study on the effect of soil improvements on the ground water contamina		90,000.00 sf	1.99 /sf	178,722
0390 Clean & Patch Concrete				
<i>A01060101 Concrete Wall Finishes</i>				
Patching concrete, walls, epoxy grout, 1/2" deep, including chipping, cleaning and epoxy grout	2150	22,000.00 sf	46.85 /sf	1,030,777
				1,030,777
<i>A01060101 Concrete Wall Finishes</i>				
Clean & Patch Concrete		22,000.00 sf	46.85 /sf	1,030,777
05126 Seismic Safety Upgrades to Steel Structure				
<i>A01020201 Structural Frame</i>				
Bracing, angles, single or double, field fabricated	7625	70,000.00 lb	15.72 /lb	1,100,099
Bracing, add for shear tabs, clip angles, plates, stiffeners	7680	7,000.00 lb	2.90 /lb	20,275
Shop or field priming columns or column bracing, red oxide, 2 coats	8050	19,250.00 sf	0.90 /sf	17,377
				1,137,751
<i>A01020201 Structural Frame</i>				
Seismic Safety Upgrades to Steel Structure		77,000.00 lb	14.78 /lb	1,137,751
05300 Redwood Deck Substitution				
<i>A01020203 Roof Decks and Slabs</i>				
Rent crawler mounted, lattice boom crane, cable, 200 ton, 70' boom	1400	25.00 day	4,446.60 /day	111,165
Metal decking composite galv non-cellular 2" 20 ga	5300	196,180.00 sf	5.38 /sf	1,054,835
Sheet metal edge closure form, to 12", w/2 bends, 18 ga	7100	500.00 lf	8.18 /lf	4,091
				1,170,090
<i>A01020203 Roof Decks and Slabs</i>				
<i>A01030102 Insulation and Vapor Barrier</i>				
Vapor Retarders, building paper, asphalt felt sheathing paper, 15#	0400	196.18 sq	33.76 /sq	6,623
				6,623
<i>A01030102 Insulation and Vapor Barrier</i>				
<i>A01040101 Roof Covering</i>				
Rolling Mill Setup Fee	0500	1.00 ls	195,572.60 /ls	195,573
				195,573
<i>A01040101 Roof Covering</i>				
Redwood Deck Substitution		196,180.00 sf	7.00 /sf	1,372,286
05400 Pivot Pin Enclosure Rehab				
<i>A01160101 Substructure & Superstructure</i>				
Pivot Pin enclosure	0100	1.00 ls	35,144.38 /ls	35,144
				35,144
<i>A01160101 Substructure & Superstructure</i>				
Pivot Pin Enclosure Rehab			/unit	35,144
05517 Roof Walkway				
<i>A0102029X Other Roof Systems</i>				
Railing, industrial, welded, steel pipe, 2 rails, 3'-6" high, posts @ 5' O.C., 1-1/2" dia x 42" H, shop fabricated	0020	1,584.00 lf	56.65 /lf	89,740
Railing, industrial, welded, steel, shop fabricated, for 4" x 10 ga kick plate, add	0200	1,584.00 lf	8.98 /lf	14,216
Floor grating, steel, painted, 3/4" x 1/8" bearing bars @ 1-3/16" O.C., cross bars @ 2" O.C., over 300 S.F., field fabricated from panels	0464	2,376.00 sf	32.31 /sf	76,764
				180,721
<i>A0102029X Other Roof Systems</i>				
Roof Walkway		792.00 lf	228.18 /lf	180,721
07300 Main Bldg Corrugated Roofing/ExpJts/Hatch				
<i>A01040101 Roof Covering</i>				
Anchor "U" Clip	0100	81,146.00 ea	4.16 /ea	337,479
Anchor bolts, J-type, 5/16" diameter x 12" long, galvanized, includes nut and washer	2200	81,146.00 ea	16.00 /ea	1,298,679
Steel roofing panels, attached to steel frame, corrugated or ribbed, galvanized, 20 gauge	0400	543,350.00 sf	11.22 /sf	6,094,581
				7,730,739
<i>A01040101 Roof Covering</i>				
<i>A01040104 Flashing and Trim</i>				
Expansion joint, Copper Sheet 22ga x 24"	1900	1,080.00 lf	72.62 /lf	78,429
				78,429
<i>A01040104 Flashing and Trim</i>				
<i>A01040105 Roofing Openings & Supports</i>				
Roof Hatches, with curb, 1" fiberglass insulation, galvanized steel curb & cover, 2'-6" x 8'	1500	2.00 ea	2,804.61 /ea	5,609
				5,609
<i>A01040105 Roofing Openings & Supports</i>				
Main Bldg Corrugated Roofing/ExpJts/Hatch		543,350.00 sf	14.38 /sf	7,814,777
07600 Ridge Vent System Complete (manual ops)				
<i>A01040104 Flashing and Trim</i>				
Sheet metal flashing, stainless steel, flexible sheets, .018" thick, 26 gauge, including up to 4 bends	9100	4,400.00 sf	18.83 /sf	82,829
Coping, stainless steel, 26 ga., 16" wall	9985	2,200.00 lf	35.52 /lf	78,132
Drip edge, galvanized, mill finish, 8" wide	0500	2,200.00 lf	3.43 /lf	7,548
Ridge Vent	2300	1,100.00 lf	540.11 /lf	594,122
				762,632
<i>A01040104 Flashing and Trim</i>				
Ridge Vent System Complete (manual ops)		1.00 ls	762,631.59 /ls	762,632
07600 Clam Shell Door Flashing				
<i>A01040104 Flashing and Trim</i>				
Flashing, galvanized steel, .018", 26 ga.	0005	2,400.00 sf	47.55 /sf	114,128
Expansion joint, roof to wall joint with extruded aluminum cover	2500	2,200.00 lf	69.01 /lf	151,820
				265,948
<i>A01040104 Flashing and Trim</i>				
Clam Shell Door Flashing		2.00 ls	132,974.08 /ls	265,948
08100 Single Exterior Doors				
<i>A01030302 Solid Doors</i>				
Doors, fire, flush, "A" label, 3 hour, composite, 18 ga., 3'-0" x 7'-0"	0680	23.00 ea	1,430.27 /ea	32,896
Add for galvanizing, average cost per leaf	2025	23.00 leaf	65.57 /leaf	1,508
Add for baked enamel finish, average cost per leaf	2040	23.00 leaf	108.90 /leaf	2,505
Metal doors, rated, receive, sort and spread, per manhour	5000	11.50 mh	81.90 /mh	942
				37,851
<i>A01030302 Solid Doors</i>				
Single Exterior Doors		23.00 leaf	1,645.68 /leaf	37,851
08100 Double Leaf Exterior Doors				
<i>A01030302 Solid Doors</i>				

DETAIL REPORT

Project: NASA Moffett Hangar 1
 Design Stage: Concept
 Project No.: 421240.01.40

Estimator: Edgerton, R
 Estimate No.: <Estimate Number>
 Rev #/Date: <Rev. No. / Date>

Description	Item	Takeoff Quantity	Total Cost/Unit	Total Amount
A01030302 Solid Doors				
Doors, fire, flush, "A" label, 3 hour, composite, 18 ga., 3'-0" x 7'-0"	0680	1.00 ea	1,430.25 /ea	1,430
Add for galvanizing, average cost per leaf	2025	1.00 leaf	65.59 /leaf	66
Add for baked enamel finish, average cost per leaf	2040	1.00 leaf	108.88 /leaf	109
Metal doors, rated, receive, sort and spread, per manhour	5000	0.50 mh	81.92 /mh	41
				<u>1,646</u>
Double Leaf Exterior Doors		1.00 leaf	1,645.68 /leaf	1,646
08115 Single Leaf Exterior Frames				
<i>A01030302 Solid Doors</i>				
Frames, steel, knock down, hollow metal, for welded frames, add	4900	23.00 ea	112.41 /ea	2,585
Steel frames, KD, 14 ga, "A" or "B" label, to 8-3/4" throat, to 3'-0" x 7'-0"	5375	23.00 ea	478.55 /ea	11,007
Steel frames, add for baked enamel finish	6400	23.00 ea	55.58 /ea	1,278
Steel frames, add for galvanizing	6500	23.00 ea	21.08 /ea	485
Door frames, receive, sort and spread, per manhour	9090	11.50 mh	81.90 /mh	942
				<u>16,297</u>
Single Leaf Exterior Frames		23.00 ea	708.57 /ea	16,297
08115 Double Leaf Exterior Frame				
<i>A01030302 Solid Doors</i>				
Frames, steel, knock down, hollow metal, for welded frames, add	4900	1.00 ea	112.38 /ea	112
Steel frames, KD, 14 ga, "A" or "B" label, to 8-3/4" throat, to 3'-0" x 7'-0"	6175	1.00 ea	664.06 /ea	664
Steel frames, KD, 14 ga, "A" or "B" label, to 8-3/4" throat, to 6'-0" x 7'-0"	6220	1.00 ea	773.82 /ea	774
Steel frames, add for baked enamel finish	6400	1.00 ea	55.58 /ea	56
Steel frames, add for galvanizing	6500	1.00 ea	21.10 /ea	21
Door frames, receive, sort and spread, per manhour	9090	0.50 mh	81.86 /mh	41
				<u>1,668</u>
Double Leaf Exterior Frame		1.00 ea	1,667.87 /ea	1,668
08410 Roll-Up Utility Doors				
<i>A01040401 Overhead and Roll-up Doors</i>				
Doors, vertical coiling, motorized, steel, 14 gauge, 10' x 20', incl. frame and control panel	0100	12.00 ea	31,139.37 /ea	373,672
				<u>373,672</u>
Roll-Up Utility Doors		12.00 ea	31,139.37 /ea	373,672
08900 Corrugated Windows				
<i>A01030201 Windows</i>				
Corrugated Windows, Steel Frame	0100	42,780.00 sf	318.24 /sf	13,614,365
				<u>13,614,365</u>
Corrugated Windows		42,780.00 sf	318.24 /sf	13,614,365
08900 Flat Glass Windows				
<i>A01030201 Windows</i>				
Windows, steel, custom units, wire reinforced glass	2100	35,680.00 sf	77.07 /sf	2,749,845
				<u>2,749,845</u>
Flat Glass Windows		35,680.00 sf	77.07 /sf	2,749,845
09050 Catwalk Rehab for Beacon Service				
<i>A0102019X Other Floor Construction</i>				
Floor grating, steel, painted, 1-1/2" x 3/16" bearing bars @ 1-3/16" O.C., cross bars @ 4" O.C., up to 300 S.F., field fabricated from panels	0432	3,000.00 sf	45.00 /sf	134,994
				<u>134,994</u>
Catwalk Rehab for Beacon Service				134,994
09250 Interior Finishes				
<i>A01030102 Insulation and Vapor Barrier</i>				
Blanket insulation, for walls or ceilings, unfaced fiberglass, 3-1/2" thick, R13, 15" wide	0820	15,000.00 sf	1.17 /sf	17,559
				<u>17,559</u>
<i>A01030102 Insulation and Vapor Barrier</i>				
<i>A01050401 Compartments, Cubicles and Toilet Partitions</i>				
Partitions, toilet, cubicles, ceiling hung, stainless steel	0500	160.00 ea	1,796.65 /ea	287,463
				<u>287,463</u>
<i>A01050401 Compartments, Cubicles and Toilet Partitions</i>				
<i>A01060103 Gypsum Wallboard Finishes</i>				
3-5/8" Metal studs, galv, 20 ga., 16" oc, non load bearing, >10' ht.	2825	15,000.00 sf	3.59 /sf	53,917
Framing, 2x4 fire treated, trimmers/lurring for door/window frames	4025	0.32 mbf	4,567.66 /mbf	1,462
18 to 16 ga x 1-1/2" channel bridging, studs 16" oc	6000	12.00 clf	212.32 /clf	2,548
Average cost, flate plate backing to 6" wide, 16 gauge	6022	240.00 lf	5.68 /lf	1,362
Studs, drive pins & studs, 1/4" & 3/8" diameter	6035	2.00 c	7.70 /c	15
Pack void between top track and flutes and seal both sides	7450	1,200.00 lf	6.97 /lf	8,368
Track gasketing, neoprene closed cell, 1/4" x 3/4"	7500	2,400.00 lf	5.48 /lf	13,145
Gypsum wallboard, on walls, fire resistant, taped & finished (level 4 finish), 5/8" thick	2150	30,000.00 sf	2.55 /sf	76,606
				<u>157,423</u>
<i>A01060103 Gypsum Wallboard Finishes</i>				
<i>A01060201 Room Finishes</i>				
Interior Finishes	3000	8,000.00 sf	94.29 /sf	754,316
				<u>754,316</u>
Interior Finishes		1,875.00 unit	648.94 /unit	1,216,762
21310 Fire Sprinklers, Conceptual				
<i>A01100301 Sprinkler Heads & System</i>				
Single standpipe connection (FHV or FDC), polished brass, 2-1/2" x 3"	7180	24.00 ea	647.33 /ea	15,536
Pendant or upright heads	3740	1,333.00 ea	162.13 /ea	216,121
Recessed heads, 135 deg to 286 deg F, 1/2" NPT, 1/2" orifice	4840	133.00 ea	250.25 /ea	33,283
Sprinkler System Components, valves, dry pipe air check type, 3" size	8000	6.00 ea	3,483.18 /ea	20,899
Fire pumps, diesel, 750 GPM, 50 psi, 44 HP, 5" pump, including controller, fittings and relief valve	0200	4.00 ea	58,054.82 /ea	232,219
Fire ps, incl contrlr, elec, 750 GPM, 100 psi, 66 HP, 3,550 RPM, 4" P	3400	8.00 ea	39,578.93 /ea	316,631
Fire pump, incl controller, elec, for jockey pump 1", 3 HP, add	5000	2.00 ea	4,963.81 /ea	9,928
Pipe, fittings and valves, steel, black, grooved joint, 20" diameter, schedule 40, includes coupling & clevis type hanger 10' O.C.	1200	24.00 lf	539.29 /lf	12,943
Fire protection loops to 2.5" dia., including hangers & fittings	1225	330.000.00 sf	1.43 /sf	471,363
Sprinkler head distribution to 1.25" dia., including hangers/fittings	1250	330,000.00 sf	1.42 /sf	467,668
Backflow pvnr, OS&Y v, & 4 1st cocks, rddc press, fig, iron, 6" pipe	5720	6.00 ea	10,423.18 /ea	62,539
Valves, iron body, swing check, flanged, 125 lb., 6"	6070	24.00 ea	2,567.56 /ea	61,621
Underground Storage Tanks, fiberglass, double wall, U.L. listed, 12,000 gal cap, incl. manways & holddown straps	3120	6.00 ea	60,122.54 /ea	360,735
Day tank, diesel, double wall stl, 500 gal capacity w/cradles&fittings	3300	1.00 ea	5,072.92 /ea	5,073
				<u>2,286,560</u>
<i>A01100301 Sprinkler Heads & System</i>				
Fire Sprinklers, Conceptual		231,000.00 sf	9.90 /sf	2,286,560

DETAIL REPORT

Project: NASA Moffett Hangar 1
 Design Stage: Concept
 Project No.: 421240.01.40

Estimator: Edgerton, R
 Estimate No.: <Estimate Number>
 Rev #/Date: <Rev. No. / Date>

Description	Item	Takeoff Quantity	Total Cost/Unit	Total Amount
22405 Commercial Plumbing, Conceptual				
<i>A01080101 Waterclosets</i>				
Water closet, bowl only, w/ flush valve, seat, wall hung	3100	214.00 ea	1,173.80 /ea	251,192
Rough in water supply, waste & vent for wall hung water closet	3200	214.00 ea	2,597.30 /ea	555,822
Carriers/supports, water closet, siphon jet, horizontal, adjustable, caulk, single, 4" pipe size	7040	214.00 ea	1,618.25 /ea	346,306
<i>A01080101 Waterclosets</i>				1,153,320
<i>A01080102 Urinals</i>				
Urinal, wall hung, vitreous china, with hanger & self-closing valve, siphon jet type	3100	44.00 ea	1,201.10 /ea	52,849
Urinal, wall hung, rough-in, supply, waste and vent	3300	44.00 ea	1,682.05 /ea	74,010
Carriers/supports, urinal, wall mounted, plate type system	6300	44.00 ea	664.06 /ea	29,219
<i>A01080102 Urinals</i>				156,077
<i>A01080103 Lavatories</i>				
Lavatory, vanity top, vitreous china, white, single bowl, 20" x 16", includes trim	2900	110.00 ea	853.21 /ea	93,853
Lavatory, vanity top, rough-in, supply, waste and vent	3580	110.00 ea	1,460.17 /ea	160,618
Carriers/supports, lavatory, concealed arm, wall mounted, in stud or masonry, flat slab fixture	3700	110.00 ea	559.36 /ea	61,529
<i>A01080103 Lavatories</i>				316,001
<i>A01080104 Sinks</i>				
Service sink, faucet and drain, floor/corner mtd, 28"x28" PE on CI	6650	3.00 ea	2,030.44 /ea	6,091
Rough in water supply, waste & vent for floor mtd. service sinks	6790	3.00 ea	3,125.16 /ea	9,375
Fcts/f.flush valve, autmtc flush sensor and opertr for urinals wtrclsts	0972	291.00 ea	913.59 /ea	265,855
Faucets/fittings, lavatory faucet, automatic sensor and operator, with faucet head, residential	2810	64.00 ea	870.86 /ea	55,735
<i>A01080104 Sinks</i>				337,057
<i>A01080106 Drinking Fountains & Coolers</i>				
Carriers/supports, drinking fountain, wall mounted, plate type with studs, top back plate	0600	4.00 ea	289.15 /ea	1,157
Water cooler, wall mounted, non-recessed, dual height, 14.3 GPH	1040	4.00 ea	2,625.08 /ea	10,500
Water cooler, for supply, waste and vent, all coolers	9800	4.00 ea	973.22 /ea	3,893
<i>A01080106 Drinking Fountains & Coolers</i>				15,550
<i>A01080201 Pipes and Fittings</i>				
Cleanout, floor type, round or square, scoriated nickel bronze top, 3" pipe size	0120	186.00 ea	572.54 /ea	106,492
Cleanout tee, cast iron, B. & S., 4" pipe size, includes countersunk plug	0240	4.00 ea	870.61 /ea	3,482
3/4" copper type L w/ fittings & hangers 10' oc, wall hydrants	2450	200.00 lf	18.21 /lf	3,641
Water sply ms, dom/coml, brz, flgd, compound, 8" dia, to 1,800 GPM	2700	1.00 ea	22,857.77 /ea	22,858
Backflow pvnr, OS&Y v,&4 tst cocks, rddc press, fig, iron, 3" pipe	5680	1.00 ea	5,628.96 /ea	5,629
Hydrant, wall type, moderate climate, bronze, anti-siphon, encased, 1" I.P.S. connection	0300	6.00 ea	1,368.77 /ea	8,213
Hydrant, wall type, non-freeze, bronze, exposed, 3/4" I.P.S connection, 4" to 9" thick wall	1100	4.00 ea	835.90 /ea	3,344
<i>A01080201 Pipes and Fittings</i>				153,659
<i>A01080301 Waste Pipe and Fittings</i>				
6" Cast iron single hub w/ fittings, extra heavy, buried	5000	500.00 lf	75.59 /lf	37,796
Trench for buried waste or drain pipe, avg. 12" W, up to 24" D	6000	500.00 lf	2.90 /lf	1,448
Hand clean and trim trench for waste/drain lines	6010	500.00 lf	4.55 /lf	2,276
Backfill and compact piping trench, avg. 12" wide to, 24" deep	6015	500.00 lf	3.83 /lf	1,917
Bedding, sand, for waste/drain piping, to 6" deep	6025	9.26 cy	47.45 /cy	439
<i>A01080301 Waste Pipe and Fittings</i>				43,877
<i>A01080303 Floor Drains</i>				
Drain, floor, medium duty, cast iron, deep flange, 7" diameter top, 2" and 3" pipe size	2040	6.00 ea	460.60 /ea	2,764
Drain, floor, medium duty, cast iron, deep flange, 7" diameter top, for polished bronze top, add	2120	6.00 ea	166.41 /ea	998
Drain, floor, heavy duty with sediment bucket, cast iron, 12" diameter loose grate, 2", 3", 4", 5" and 6" pipe size	2420	2.00 ea	1,239.25 /ea	2,479
<i>A01080303 Floor Drains</i>				6,241
<i>A01080603 Interceptors</i>				
Interceptor, oil, fabricated steel, 100 GPM, 3" pipe size	4220	1.00 ea	22,492.90 /ea	22,493
<i>A01080603 Interceptors</i>				22,493
<i>A01090105 Hot Water Supply System (Cent Plant)</i>				
Comm'l water heater, 100 deg rise, elec, 50 gal., 9 kW, 37 GPH, 208V	4140	2.00 ea	6,735.15 /ea	13,470
<i>A01090105 Hot Water Supply System (Cent Plant)</i>				13,470
Commercial Plumbing, Conceptual		2,500.00 sf	887.10 /sf	2,217,744
23525 HVAC Garage Exhaust, Conceptual				
<i>A01090401 Air Distribution, Cooling and Heating</i>				
Rectangular galv steel duct w/ fittings & supports, garage exhaust	4000	94,050.00 lb	10.90 /lb	1,025,425
Garage exhaust fans, centrifugal, axial or v-belt, avg. cost per cfm	9700	285,000.00 cfm	0.82 /cfm	234,966
<i>A01090401 Air Distribution, Cooling and Heating</i>				1,260,391
<i>A01090601 HVAC Controls</i>				
Electric timeclock controls, shell equipment only	0010	1.00 ls	13,179.14 /ls	13,179
<i>A01090601 HVAC Controls</i>				13,179
HVAC Garage Exhaust, Conceptual		231,000.00 sf	5.51 /sf	1,273,570
26022 Electrical Service, 1200A				
<i>A01110101 Main Transformers</i>				
Transformer, oil-filled, 15 kV with taps, 480 V secondary 3 phase, 1500 kVA, pad mounted	0600	4.00 ea	75,258.24 /ea	301,033
Transformer, dry-type, 3 phase 480 V primary 120/208 V secondary, 225 kVA	4300	12.00 ea	22,898.62 /ea	274,783
<i>A01110101 Main Transformers</i>				575,816
<i>A01110103 Main Switchboards</i>				
Main switchboards,w/ disconnect & CB, 3P, 4W, avg cost per amp	6000	4,800.00 amp	48.31 /amp	231,863
Distribution switchboards,120/208v or 277/480v, avg cost per amp	2000	2,400.00 amp	41.05 /amp	98,523
<i>A01110103 Main Switchboards</i>				330,386
<i>A01110105 Panels</i>				
Panelboards, 3 phase 4 wire, main lugs, 120/208 V, 225 amp, 42 circuits, NQOD, incl 20 A 1 pole plug-in breakers	1000	24.00 ea	5,742.97 /ea	137,831

DETAIL REPORT

Project: NASA Moffett Hangar 1
 Design Stage: Concept
 Project No.: 421240.01.40

Estimator: Edgerton, R
 Estimate No.: <Estimate Number>
 Rev #/Date: <Rev. No. / Date>

Description	Item	Takeoff Quantity	Total Cost/Unit	Total Amount
A01110105 Panels				
Panelboards, 3 phase 4 wire, main lugs, 277/480 V, 225 amp, 36 circuits, NEHB, incl 20 A 1 pole plug-in breakers	1450	24.00 ea	8,143.52 /ea	195,445
				333,276
A01110107 Motor Circuit Breakers				
Motor connections, flexible conduit and fittings, 3 phase, 230 volt, 25 HP motor	0200	4.00 ea	464.86 /ea	1,859
Motor starter, combination, with fused switch, size 1, 10 HP, NEMA 1	1600	4.00 ea	2,140.70 /ea	8,563
				10,422
A0111019X Service and Distribution				
Wire, copper, stranded, 600 volt, 600 kcmil, type XHHW, in raceway	3340	90.00 cft	3,550.47 /cft	319,542
Electrical Underground Ducts and Manholes, PVC, conduit with coupling, 4" diameter, schedule 40, installed by direct burial in slab or duct bank	1070	2,000.00 lf	23.03 /lf	46,052
Electrical Underground Ducts and Manholes, PVC, conduit with coupling, 6" diameter, schedule 40, installed by direct burial in slab or duct bank	1090	4,000.00 lf	42.49 /lf	169,955
Electrical Underground Ducts and Manholes, PVC, bell end and cap, 4" diameter, schedule 40, installed by direct burial in slab or duct bank	1370	40.00 ea	108.11 /ea	4,324
Electrical Underground Ducts and Manholes, PVC, bell end and cap, 6" diameter, schedule 40, installed by direct burial in slab or duct bank	1390	32.00 ea	160.12 /ea	5,124
Electrical Underground Ducts and Manholes, PVC, base spacer, 4" diameter, schedule 40, installed by direct burial in slab or duct bank	1470	400.00 ea	25.96 /ea	10,385
Electrical Underground Ducts and Manholes, PVC, base spacer, 6" diameter, schedule 40, installed by direct burial in slab or duct bank	1490	800.00 ea	32.12 /ea	25,698
				581,080
A01110201 Branch Wiring				
Cable terminations, indoor, insulation diameter range, 15 kV, .975" to 1.570", pad mount	0900	24.00 ea	475.00 /ea	11,400
Medium-cable single cable, copper, XLP shielding, ungrounded neutral, 15 kV, 1/0, in conduit, excl splicing & terminations	1800	70.00 cft	1,256.94 /cft	87,986
Switchboard instruments, 3 phase 4 wire, AC indicating, wattmeter	0300	4.00 ea	7,912.61 /ea	31,650
Switchboard instruments, ground fault protection, zero sequence	0600	4.00 ea	12,649.14 /ea	50,597
				181,633
Electrical Service, 1200A		4.00 svcs	503,153.39 /svcs	2,012,614
26024 Clam Shell Door Motors				
<i>A01040402 Hanger Doors</i>				
Motor connections, flexible conduit and fittings, 3 phase, 230 volt, 25 HP motor	0200	1.00 ea	464.86 /ea	465
Motor replacement, special fabrication to match existing on external	1600	1.00 ea	19,966.85 /ea	19,967
				20,432
Clam Shell Door Motors		1.00 ea	20,431.71 /ea	20,432
26024 Clam Shell Door Service				
<i>A01040402 Hanger Doors</i>				
Clam Shell Pivot Pins	0100	2.00 ea	38,187.36 /ea	76,375
Truck & Gear Box Service	0200	3.00 ea	4,097.72 /ea	12,293
Motor Service	1600	3.00 ea	6,355.29 /ea	19,066
				107,734
Clam Shell Door Service		3.00 sf	35,911.25 /sf	107,734
26026 T5HO interior lighting				
<i>A0111019X Service and Distribution</i>				
Wire, copper, stranded, 600 volt, #8, type THWN-THHN, in raceway	1300	200.00 cft	475.86 /cft	95,172
				95,172
<i>A01110202 Lighting Equipment</i>				
Fluorescent fixture, interior, pendant mounted, 6-54 W, T5HO, 2' W x 4' L, incl lamps, mounting hardware and connections	2952	100.00 ea	1,522.03 /ea	152,203
				152,203
<i>A01120201 General Construction Items</i>				
Rigid galvanized steel conduit, 3/4" diameter, to 15' H, incl 2 terminations, 2 elbows & 11 beam clamps per 100 LF	1770	5,000.00 lf	54.56 /lf	272,795
				272,795
T5HO interior lighting		100.00 fixt	5,201.71 /fixt	520,171
26026 Metal Halide and HPS HI Bay Lighting				
<i>A0111019X Service and Distribution</i>				
Wire, copper, stranded, 600 volt, #8, type THWN-THHN, in raceway	1300	200.00 cft	475.86 /cft	95,172
				95,172
<i>A01110202 Lighting Equipment</i>				
High pressure sodium fixture, interior, recessed, square, 1000 W, incl lamps, and mounting hardware	0840	50.00 ea	3,906.50 /ea	195,325
Metal halide fixture, interior, vaporproof, pendant, 1000 W, incl lamps, and mounting hardware	3420	50.00 ea	5,181.50 /ea	259,075
				454,400
<i>A01120201 General Construction Items</i>				
Rigid galvanized steel conduit, 3/4" diameter, to 15' H, incl 2 terminations, 2 elbows & 11 beam clamps per 100 LF	1770	5,000.00 lf	54.56 /lf	272,795
				272,795
Metal Halide and HPS HI Bay Lighting		100.00 fixt	8,223.68 /fixt	822,368
26026 T8 interior lighting				
<i>A0111019X Service and Distribution</i>				
Wire, copper, stranded, 600 volt, #10, type THWN-THHN, in raceway	1250	50.00 cft	146.36 /cft	7,318
				7,318
<i>A01110202 Lighting Equipment</i>				
Fluorescent fixture, interior, strip, pendant mounted, industrial, white porcelain enamel, 2-32 w t8, 41, incl lamps, mounting hardware and connections	3110	100.00 ea	328.88 /ea	32,888
				32,888
<i>A01120201 General Construction Items</i>				
Rigid galvanized steel conduit, 3/4" diameter, to 15' H, incl 2 terminations, 2 elbows & 11 beam clamps per 100 LF	1770	1,500.00 lf	18.71 /lf	28,062
				28,062
T8 interior lighting		100.00 fixt	682.68 /fixt	68,268

DETAIL REPORT

Project: NASA Moffett Hangar 1
 Design Stage: Concept
 Project No.: 421240.01.40

Estimator: Edgerton, R
 Estimate No.: <Estimate Number>
 Rev #/Date: <Rev. No. / Date>

Description	Item	Takeoff Quantity	Total Cost/Unit	Total Amount
A0112019X Other Communication & Alarm Systems				
Unshielded twisted pair (UTP) cable, solid, plenum, #24, 4 pair, category 6	7242	300.00 cf	286.03 /cf	85,808
Unshielded twisted pair (UTP) jack, RJ-45, category 6	7316	200.00 ea	25.78 /ea	5,156
Voice/Data outlets, two jack opening, excl voice/data devices	0140	100.00 ea	27.60 /ea	2,760
				<u>93,725</u>
A01120201 General Construction Items				
Beam clamp and LV cable ring	5550	5,000.00 ea	30.58 /ea	152,912
Telecom horizontal				<u>152,912</u>
		100.00 outl	2,466.36 /outl	246,636
26030 Receptacles				
A0111019X Service and Distribution				
Wire, copper, stranded, 600 volt, #10, type THWN-THHN, in raceway	1250	100.00 cf	146.36 /cf	14,636
				<u>14,636</u>
A01110201 Branch Wiring				
Duplex receptacle, ground fault interrupting, 20 amp	2482	80.00 ea	113.77 /ea	9,101
				<u>9,101</u>
A01120201 General Construction Items				
Rigid galvanized steel conduit, 3/4" diameter, to 15' H, incl 2 terminations, 2 elbows & 11 beam clamps per 100 LF	1770	3,200.00 lf	18.71 /lf	59,865
Outlet boxes, cast, weatherproof receptacle cover, 1 gang	1600	80.00 ea	32.09 /ea	2,567
Outlet boxes, cast, FSC, 1 gang, 3/4" hub	1760	80.00 ea	145.51 /ea	11,641
				<u>74,073</u>
Receptacles		80.00 rcpt	1,222.62 /rcpt	97,810
26710 T5HO Lighting control				
A01110103 Main Switchboards				
Lighting contactors, 3 pole, electrically held, 600 volt, 30 amp, NEMA 1	0200	16.00 ea	940.74 /ea	15,052
Misc lighting control panel and processor	1000	4.00 ea	3,106.82 /ea	12,427
				<u>27,479</u>
T5HO Lighting control			/sf	27,479
26710 Com rooms				
A01120103 Telephone Systems				
Electrical Underground Ducts and Manholes, PVC, conduit with coupling, 4" diameter, schedule 40, installed by direct burial in slab or duct bank	1070	10,000.00 lf	23.03 /lf	230,260
Electrol undrgrnd ducts and manholes,hand holes,precast concrete,with concrete cover,4'x4'x4'deep,excludes excavation,backfill and cast place concrete	1000	8.00 ea	4,228.71 /ea	33,830
				<u>264,090</u>
A0112019X Other Communication & Alarm Systems				
Com room rack allowance	3040	4.00 ea	11,880.04 /ea	47,520
Fiber optic connector	0300	96.00 ea	83.75 /ea	8,040
Fiber optics cable, outdoor, 62.5 microns, aerial/duct	1040	5,000.00 lf	3.00 /lf	14,976
				<u>70,536</u>
Com rooms		4.00 ea	83,656.49 /ea	334,626
26712 AV system				
A01120107 Television Systems				
AV system - raceways and outlets only	1800	80.00 ottl	1,758.57 /ottl	140,685
				<u>140,685</u>
AV system			/sf	140,685
26712 Public Address System				
A01120104 Public Address Systems				
PA interface to telecom	1100	4.00 ea	7,421.54 /ea	29,686
Public address system, conventional, industrial	0200	100.00 spkr	880.98 /spkr	88,098
				<u>117,784</u>
Public Address System			/sf	117,784
31260 Underpinning & Soil Mixing				
A01010203 Underpinning				
Concrete pressure grouting, cement and sand, 1:1 mix, maximum	0100	28,274.40 cf	105.33 /cf	2,978,019
				<u>2,978,019</u>
Underpinning & Soil Mixing		240.00 ea	12,408.41 /ea	2,978,019
32740 Infill Grout at Door Truck Rail				
A01040402 Hanger Doors				
Epoxy Rail Grout (Five Star DP Epoxy Grout)	7950	750.00 cf	623.31 /cf	467,478
				<u>467,478</u>
Infill Grout at Door Truck Rail		1,000.00 LF	467.48 /LF	467,478
33630 Trench Floor Drains and Connections				
A01080303 Floor Drains				
Drain, trench, polyester polymer for cement concrete encasement, 12" internal width, with heavy duty galvanized grate	6770	2,200.00 lf	264.10 /lf	581,025
Public Sanitary Utility Sewerage Piping, piping polyvinyl chloride pipe, B & S, 13' lengths, 12" diameter, SDR 35, excludes excavation or backfill	2160	500.00 lf	34.54 /lf	17,270
				<u>598,295</u>
Trench Floor Drains and Connections		2,200.00 lf	271.95 /lf	598,295
D Option D: Adaptive Re-Use, Re-Skinning with Upgrades (Geotechnical, St		1.00 ls	45,264,130.18 /ls	45,264,130

DETAIL REPORT

Project NASA Moffett Hangar 1
 Design Stage: Concept
 Project No.: 421240.01.40

Estimator: Edgerton, R
 Estimate No.: <Estimate Number>
 Rev #/Date: <Rev. No. / Date>

Description	Item	Takeoff Quantity	Total Cost/Unit	Total Amount
E1 Option E1: Layaway Plan after Re-Skinning (Annual Cost 2011 \$)				
33630				
<i>A01120201 General Construction Items</i>				
Annual Electrical Power for Infrared Heaters	0200	1.00 ls	2,108.67 /ls	2,109
Annual Maintenance & Clearing of Infrared Heaters	0600	1.00 ls	9,061.37 /ls	9,061
Clamshell Door Maintenance	5700	1.00 ls	3,775.96 /ls	3,776
Ground Maintenance & Rodent Control	0050	25,000.00 sy	8.64 /sy	215,927
Roof Inspection	0250	1.00 ls	64,763.92 /ls	64,764
Maintain HEF System & Basic Utilities	----	1.00 lsum	9,772.89 /lsum	9,773
Clean & Maintain Trench Drains	----	2,000.00 lf	2.44 /lf	4,886
<i>A01120201 General Construction Items</i>				<u>310,296</u>
33630				
E1 Option E1: Layaway Plan after Re-Skinning (Annual Cost 2011 \$)		1.00 yr	310,295.94 /yr	310,296

DETAIL REPORT

Project NASA Moffett Hangar 1
 Design Stage: Concept
 Project No.: 421240.01.40

Estimator: Edgerton, R
 Estimate No.: <Estimate Number>
 Rev #/Date: <Rev. No. / Date>

Description	Item	Takeoff Quantity	Total Cost/Unit	Total Amount
E2 Option E2: Layaway Plan without Re-Skinning (Annual Cost 2011 \$)				
33630				
<i>A01120201 General Construction Items</i>				
Clamshell Door Maintenance	5700	1.00 ls	3,775.95 /ls	3,776
Ground Maintenance & Rodent Control	0050	25,000.00 sy	8.64 /sy	215,927
Bird Monitoring/Mitigation and repairs on exposed structure	----	1.00 lsum	12,378.53 /lsum	12,379
Steel Connection Inspections Annual	----	1.00 lsum	17,410.25 /lsum	17,410
Protection, Inspection, and Maintenance of 6 Electrical Vaults	----	6.00 each	1,722.83 /each	10,337
Clean & Maintain Trench Drains	----	2,000.00 lf	2.44 /lf	4,886
<i>A01120201 General Construction Items</i>				<u>264,715</u>
33630				264,715
E2 Option E2: Layaway Plan without Re-Skinning		1.00 yr	264,714.86 /yr	264,715
(Annual Cost 2011 \$)				

Description	Item	Takeoff Quantity	Total Cost/Unit	Total Amount
F Option F: Building Demolition				
01400 Testing & Inspection				
<i>A0116029X Other Hazardous Selective Building Demolition</i>				
Soil testing, maximum	5150	450.00 ea	957.68 /ea	430,958
Earthwork inspection technician, per day	5550	90.00 day	650.17 /day	58,515
Steel Haz-Mat inspection technician, per day	5790	90.00 day	650.17 /day	58,515
Steel Coating Tests	5860	450.00 ea	790.75 /ea	355,837
				903,826
<i>A0116029X Other Hazardous Selective Building Demolition</i>				
Testing & Inspection		1.00 ls	903,825.58 /ls	903,826
02221 Utility Removal				
<i>A0116029X Other Hazardous Selective Building Demolition</i>				
Temporary Fencing, chain link, rented up to 12 months, 6' high, 11 ga, over 1000'	0250	5,000.00 lf	10.83 /lf	54,153
Minor site demolition, hydrants, fire, remove and reset, excludes hauling	0950	20.00 ea	2,125.64 /ea	42,513
Minor site demolition, pipe, sewer/water, 12" diameter, remove, excludes excavation, hauling	2900	500.00 lf	12.70 /lf	6,349
Minor site demolition, pipe, sewer/water, 15" to 18" diameter, remove, excludes excavation, hauling	2930	500.00 lf	32.32 /lf	16,162
				119,177
<i>A0116029X Other Hazardous Selective Building Demolition</i>				
Utility Removal		1,000.00 lf	119.18 /lf	119,177
02225 Structural Framing Demo				
<i>A01160102 Exterior Closure Demolition</i>				
Structural Steel Salvage	0390	-40,000,000.00 lb	0.46 /lb	(18,267,155)
Framing demo, steel framing,	2520	40,000,000.00 lb	0.43 /lb	17,304,986
				(962,169)
<i>A01160102 Exterior Closure Demolition</i>				
Structural Framing Demo		40,000,000.00 lb	(0.02) /lb	(962,168)
02225 Concrete Demo				
<i>A0116019X Other Non-Hazardous Selective Building Demolition</i>				
Bldg. footings and foundations demolition, floors, concrete slab on grade, concrete, rod reinforced, 6" thick, excludes disposal costs and dump fees	0440	385,000.00 sf	9.69 /sf	3,729,113
Demo Material handling, loading & trucking, machine loading truck, includes 2 mile haul, cost to be added to demolition cost.	3080	10,462.96 cy	28.63 /cy	299,597
				4,028,710
<i>A0116019X Other Non-Hazardous Selective Building Demolition</i>				
Concrete Demo		385,000.00 sf	10.46 /sf	4,028,710
02790 Security Fence				
<i>A01030109 Exterior Fencing</i>				
Fence, chain link industrial, galvanized steel, 6 ga. wire, 2-1/2" posts @ 10' OC, 8' high, includes excavation, in concrete, excludes barbed wire	0920	4,000.00 lf	63.98 /lf	255,925
				255,925
<i>A01030109 Exterior Fencing</i>				
Security Fence			/unit	255,925
13280 PCB Abatement				
<i>A01160102 Exterior Closure Demolition</i>				
Bulk PCB Removal, from beams, incl. disp. tools & 4 suits & resp./day/worker	0160	400,000.00 sf	76.27 /sf	30,508,940
PCB waste Packaging, Handling & Disposal, collect and bag bulk material, 2 cy SuperSacks	0200	800.00 ea	779.72 /ea	623,773
PCB waste Packaging, Handling & Disposal, haul SuperSacks to Rail and load	3000	800.00 ea	268.08 /ea	214,467
PCB waste Packaging, Handling & Disposal, disposal charges, Incl. haul, Arlington, OR via Rail Car.	5000	2,000.00 tn	351.44 /tn	702,888
				32,050,067
<i>A01160102 Exterior Closure Demolition</i>				
PCB Abatement		40,000,000.00 lb	0.80 /lb	32,050,067
26022 Xfmr Demo				
<i>A0116029X Other Hazardous Selective Building Demolition</i>				
Switchboard instruments, 3 phase 4 wire, AC indicating, wattmeter	0300	3.00 ea	33.64 /ea	101
Switchboard instruments, ground fault protection, zero sequence	0600	3.00 ea	99.59 /ea	299
Transformer, dry-type, 3 phase 480 V primary 120/208 V secondary, 112.5 kVA	3900	2.00 ea	767.20 /ea	1,534
Transformer, dry-type, 3 phase 480 V primary 120/208 V secondary, 225 kVA	4300	2.00 ea	1,057.39 /ea	2,115
Main switchboards,w/ disconnect & CB, 3P, 4W, avg cost per amp	6000	4,200.00 amp	6.73 /amp	28,261
				32,310
<i>A0116029X Other Hazardous Selective Building Demolition</i>				
Xfmr Demo		325,000.00 sf	0.10 /sf	32,310
31315 Contaminated Soil Removal				
<i>A0116029X Other Hazardous Selective Building Demolition</i>				
Mobilization or demobilization, dozer, loader, backhoe or excavator, 70 H.P. to 150 H.P., up to 50 miles	0020	25.00 ea	408.65 /ea	10,216
Soils for earthwork, common borrow, spread with 200 H.P. dozer, includes load at pit and haul, 2 miles round trip, excludes compaction	0200	36,611.00 cy	41.07 /cy	1,503,538
Excavating, bulk bank measure, 2 C.Y. capacity = 130 C.Y./hour, backhoe, hydraulic, crawler mounted, excluding truck loading	0260	36,611.11 bcy	2.67 /bcy	97,726
Backfill, bulk, 6" to 12" lifts, dozer backfilling, compaction with sheepfoot roller	1700	36,611.00 ecy	71.43 /ecy	2,615,129
Hauling, excavated or borrow material, loose cubic yards, 20 mile round trip, 0.5 loads/hour, 20 C.Y. dump trailer, highway haulers, excludes loading	1255	36,611.11 lcy	102.08 /lcy	3,737,286
				7,963,895
<i>A0116029X Other Hazardous Selective Building Demolition</i>				
Contaminated Soil Removal		36,611.11 cy	217.53 /cy	7,963,895
F Option F: Building Demolition		1.00 ls	44,391,740.70 /ls	44,391,741

Description	Item	Takeoff Quantity	Total Cost/Unit	Total Amount
Z01 Substitution 1: Redwood Roof Deck				
05300 Redwood Deck Substitution				
<i>A01020203 Roof Decks and Slabs</i>				
Rent crawler mounted, lattice boom crane, cable, 200 ton, 70' boom	1400	-25.00 day	4,446.60 /day	(111,165)
Metal decking composite galv non-cellular 2" 20 ga	5300	-196,180.00 sf	5.38 /sf	(1,054,835)
Sheet metal edge closure form, to 12", w/2 bends, 18 ga	7100	-500.00 lf	8.18 /lf	(4,091)
				(1,170,090)
Redwood Deck Substitution		196,180.00 sf	(5.96) /sf	(1,170,090)
06120 Redwood Deck Replacement				
<i>A01020201 Structural Frame</i>				
Rent crawler mounted, lattice boom crane, cable, 200 ton	1400	25.00 day	4,446.60 /day	111,165
Mobilization or demobilization, crane, crawler-mounted, over 75 ton	2300	2.00 ea	7,334.35 /ea	14,669
Redwood Deck, 2" x 6"	6070	392.36 mbf	11,077.33 /mbf	4,346,299
				4,472,133
Redwood Deck Replacement		196,180.00 sf	22.80 /sf	4,472,133
Z01 Substitution 1: Redwood Roof Deck		1.00 ls	3,302,042.53 /ls	3,302,043

DETAIL REPORT

Project: NASA Moffett Hangar 1
 Design Stage: Concept
 Project No.: 421240.01.40

Estimator: Edgerton, R
 Estimate No.: <Estimate Number>
 Rev #/Date: <Rev. No. / Date>

Description	Item	Takeoff Quantity	Total Cost/Unit	Total Amount
Z02 Substitution 2: Panelized Roof Deck Installation				
07300 Main Bldg Corrugated Roofing/ExpJts/Hatch				
<i>A01040101 Roof Covering</i>				
Anchor "U" Clip	0100	-81,146.00 ea	4.16 /ea	(337,479)
Anchor bolts, J-type, 5/16" diameter x 12" long, galvanized, includes nut and washer	2200	-81,146.00 ea	16.00 /ea	(1,298,679)
Steel roofing panels, attached to steel frame, corrugated or ribbed, galvanized, 20 gauge	0400	-543,350.00 sf	11.22 /sf	(6,094,581)
<i>A01040101 Roof Covering</i>				<u>(7,730,739)</u>
Main Bldg Corrugated Roofing/ExpJts/Hatch		543,350.00 sf	(14.23) /sf	(7,730,739)
07300 Main Bldg Corrugated Roofing/ExpJts/Hatch				
<i>A01040101 Roof Covering</i>				
Anchor "U" Clip	0100	81,146.00 ea	4.16 /ea	337,479
Anchor bolts, J-type, 5/16" diameter x 12" long, galvanized, includes nut and washer	2200	81,146.00 ea	16.00 /ea	1,298,679
Steel roofing panels, attached to steel frame, corrugated or ribbed, galvanized, 20 gauge	0400	543,350.00 sf	9.55 /sf	5,190,991
<i>A01040101 Roof Covering</i>				<u>6,827,149</u>
Main Bldg Corrugated Roofing/ExpJts/Hatch		543,350.00 sf	12.57 /sf	6,827,149
Z02 Substitution 2: Panelized Roof Deck Installation		1.00 ls	(903,589.39) /ls	(903,589)

DETAIL REPORT

Project NASA Moffett Hangar 1
 Design Stage: Concept
 Project No.: 421240.01.40

Estimator: Edgerton, R
 Estimate No.: <Estimate Number>
 Rev #/Date: <Rev. No. / Date>

Description	Item	Takeoff Quantity	Total Cost/Unit	Total Amount
Z03 Substitution 3: U.S. Corrugated Glass				
08900 Corrugated Windows				
<i>A01030201 Windows</i>				
Corrugated Windows, Steel Frame	0100	-42,780.00 sf	318.24 /sf	(13,614,365)
<i>A01030201 Windows</i>			/sf	(13,614,365)
Corrugated Windows		42,780.00 sf	(318.24) /sf	(13,614,365)
08900 Corrugated Windows				
<i>A01030201 Windows</i>				
Corrugated Windows (U.S. MANUFACTURE), Steel Frame	0100	42,780.00 sf	390.69 /sf	16,713,845
<i>A01030201 Windows</i>			/sf	16,713,845
Corrugated Windows		42,780.00 sf	390.69 /sf	16,713,845
Z03 Substitution 3: U.S. Corrugated Glass		1.00 ls	3,099,479.91 /ls	3,099,480

DETAIL REPORT

Description	Item	Takeoff Quantity	Total Cost/Unit	Total Amount
Z04 Substitution 4: Flat Glass in Lieu of Corrugated Glass				
08900 Flat Glass Windows				
<i>A01030201 Windows</i>				
Windows, steel, custom units, wire reinforced glass	2100	42,780.00 sf	77.07 /sf	3,297,039
<i>A01030201 Windows</i>				
Flat Glass Windows		42,780.00 sf	77.07 /sf	3,297,039
08900 Corrugated Windows				
<i>A01030201 Windows</i>				
Corrugated Windows, Steel Frame	0100	-42,780.00 sf	318.24 /sf	(13,614,365)
<i>A01030201 Windows</i>				
Corrugated Windows		42,780.00 sf	(318.24) /sf	(13,614,365)
Z04 Substitution 4: Flat Glass in Lieu of Corrugated Glass		1.00 ls	(10,317,325.94) /ls	(10,317,326)
Glass				

DETAIL REPORT

Description	Item	Takeoff Quantity	Total Cost/Unit	Total Amount
Z05 Substitution 5 - Corrugated Fiberglass in Lieu of Corrugated Glass				
08900 Fiberglass Windows				
<i>A01030201 Windows</i>				
Corrugated Windows Steel Frame w/FiberGlass infill	2100	42,780.00 sf	37.12 /sf	1,587,966
<i>A01030201 Windows</i>			/sf	1,587,966
Fiberglass Windows		42,780.00 sf	37.12 /sf	1,587,966
08900 Corrugated Windows				
<i>A01030201 Windows</i>				
Corrugated Windows, Steel Frame	0100	-42,780.00 sf	318.24 /sf	(13,614,365)
<i>A01030201 Windows</i>			/sf	(13,614,365)
Corrugated Windows		42,780.00 sf	(318.24) /sf	(13,614,365)
Z05 Substitution 5 - Corrugated Fiberglass in Lieu of Corrugated Glass		1.00 ls	(12,026,399.23) /ls	(12,026,399)

Description	Item	Takeoff Quantity	Total Cost/Unit	Total Amount
Z06 Substitution 6: Translucent Panels for Window Openings				
08900 Corrugated Windows				
<i>A01030201 Windows</i>				
Corrugated Windows, Steel Frame	0100	-42,780.00 sf	318.24 /sf	(13,614,365)
<i>A01030201 Windows</i>				
Corrugated Windows		42,780.00 sf	(318.24) /sf	(13,614,365)
08900 Flat Glass Windows				
<i>A01030201 Windows</i>				
Windows, steel, custom units, wire reinforced glass	2100	-35,680.00 sf	77.07 /sf	(2,749,845)
<i>A01030201 Windows</i>				
Flat Glass Windows		35,680.00 sf	(77.07) /sf	(2,749,845)
08900 Translucent Panel Windows				
<i>A01030201 Windows</i>				
Skyroofs, translucent panels, 2-3/4" thick	0100	78,460.00 sf	63.87 /sf	5,010,886
<i>A01030201 Windows</i>				
Translucent Panel Windows		78,460.00 sf	63.87 /sf	5,010,886
Z06 Substitution 6: Translucent Panels for Window Openings		1.00 ls	(11,353,324.55) /ls	(11,353,325)

Project NASA Moffett Hangar 1
 Design Stage: Concept
 Project No.: 421240.01.40

Estimator: Edgerton, R
 Estimate No.: <Estimate Number>
 Rev #/Date: <Rev. No. / Date>

Description	Item	Takeoff Quantity	Total Cost/Unit	Total Amount
Z07 Substitution 7: Custom Panel Profiles				
08900				
A01040101 Roof Covering				
Rolling Mill Setup Fee	0500	1.00 ls	195,572.61 /ls	195,573
A01040101 Roof Covering			/sf	195,573
08900				195,573
Z07 Substitution 7: Custom Panel Profiles		1.00 ea	195,572.61 /ea	195,573

DETAIL REPORT

Project NASA Moffett Hangar 1
 Design Stage: Concept
 Project No.: 421240.01.40

Estimator: Edgerton, R
 Estimate No.: <Estimate Number>
 Rev #/Date: <Rev. No. / Date>

Description	Item	Takeoff Quantity	Total Cost/Unit	Total Amount
Z08a Substitution 8a: 30% Concrete Slab Removal				
02225 Concrete Demo				
<i>A0116019X Other Non-Hazardous Selective Building Demolition</i>				
Bldg. footings and foundations demolition, floors, concrete slab on grade, concrete, rod reinforced, 6" thick, excludes disposal costs and dump fees	0440	69,300.00 sf	9.69 /sf	671,240
Demo Material handling, loading & trucking, machine loading truck, includes 2 mile haul, cost to be added to demolition cost.	3080	3,138.89 cy	28.63 /cy	89,879
				761,119
<i>A0116019X Other Non-Hazardous Selective Building Demolition</i>				
Concrete Demo		69,300.00 sf	10.98 /sf	761,119
03330 New Hangar Floor and Ramp Area				
<i>A01020103 Floor Decks and Slabs</i>				
Concret fnshng,floors,basic fnshng for unspcf fltwrk,bull float,manual float&broom finish,inclds edging and joints,excluds placing,striking off&ensldtng	0150	69,300.00 sf	1.08 /sf	75,065
Concrete finishing, floor, hardener, non-metallic, medium service, 0.75 psf, add	2350	69,300.00 sf	1.69 /sf	117,301
				192,366
<i>A01020103 Floor Decks and Slabs</i>				
New Hangar Floor and Ramp Area		231,000.00 sf	0.83 /sf	192,366
03330 New Hangar Floor and Ramp Area				
<i>A01010302 Structural Slab on Grade</i>				
Aggregate, sand, washed, for concrete, loaded at the pit, includes material only	0950	427.78 cy	48.16 /cy	20,603
Aggregate, stone, 3/4" to 1-1/2", includes material only	1050	855.56 cy	74.34 /cy	63,602
Underslab vapor barrier, visqueen membrane to 6 mil	1200	69,300.00 sf	0.34 /sf	23,285
Concrete, ready mix, regular weight, slabs/mats, 5000 psi	0405	3,927.00 cy	245.10 /cy	962,521
Curing, sprayed membrane curing compound	0300	693.00 csf	24.86 /csf	17,225
Fine grading, fine grade for slab on grade, machine	1100	7,700.00 sy	2.17 /sy	16,716
				1,103,952
<i>A01010302 Structural Slab on Grade</i>				
New Hangar Floor and Ramp Area		69,300.00 sf	15.93 /sf	1,103,952
03330 New Hangar Floor and Ramp Area				
<i>A01010205 Raft Foundations</i>				
C.I.P. concrete forms, mat foundation, plywood, 1 use, includes erecting, bracing, stripping and cleaning	0020	6,750.00 sfca	23.06 /sfca	155,629
Structural concrete, placing, foundation mat, pumped, over 20 C.Y., includes strike off & consolidation, excludes material	2950	3,927.00 cy	16.28 /cy	63,934
				219,563
<i>A01010205 Raft Foundations</i>				
New Hangar Floor and Ramp Area		231,000.00 sf	0.95 /sf	219,563
31315 Contaminated Soil Removal				
<i>A0116029X Other Hazardous Selective Building Demolition</i>				
Mobilization or demobilization, dozer, loader, backhoe or excavator, 70 H.P. to 150 H.P., up to 50 miles	0020	8.00 ea	3,129.20 /ea	25,034
Soils for earthwork, common borrow, spread with 200 H.P. dozer, includes load at pit and haul, 2 miles round trip, excludes compaction	0200	10,983.30 cy	41.07 /cy	451,061
Excavating, bulk bank measure, 2 C.Y. capacity = 130 C.Y./hour, backhoe, hydraulic, crawler mounted, excluding truck loading	0260	10,983.33 bcy	2.67 /bcy	29,318
Backfill, bulk, 6" to 12" lifts, dozer backfilling, compaction with sheepsfoot roller	1700	10,983.30 ecy	71.43 /ecy	784,539
Hauling, excavated or borrow material, loose cubic yards, 20 mile round trip, 0.5 loads/hour, 20 C.Y. dump trailer, highway haulers, excludes loading	1255	10,983.33 lcy	102.08 /lcy	1,121,186
				2,411,137
<i>A0116029X Other Hazardous Selective Building Demolition</i>				
Contaminated Soil Removal		10,983.00 cy	219.53 /cy	2,411,137
Z08a Substitution 8a: 30% Concrete Slab Removal		1.00 Is	4,688,137.46 /Is	4,688,137

Description	Item	Takeoff Quantity	Total Cost/Unit	Total Amount
Z08b Substitution 8b: 60% Concrete Slab Removal				
02225 Concrete Demo				
<i>A0116019X Other Non-Hazardous Selective Building Demolition</i>				
Bldg. footings and foundations demolition, floors, concrete slab on grade, concrete, rod reinforced, 6" thick, excludes disposal costs and dump fees	0440	138,600.00 sf	9.69 /sf	1,342,481
Demo Material handling, loading & trucking, machine loading truck, includes 2 mile haul, cost to be added to demolition cost.	3080	6,277.78 cy	28.63 /cy	179,758
				1,522,239
<i>A0116019X Other Non-Hazardous Selective Building Demolition</i>				
Concrete Demo		138,600.00 sf	10.98 /sf	1,522,239
03330 New Hangar Floor and Ramp Area				
<i>A01010302 Structural Slab on Grade</i>				
Aggregate, sand, washed, for concrete, loaded at the pit, includes material only	0950	855.56 cy	48.16 /cy	41,207
Aggregate, stone, 3/4" to 1-1/2", includes material only	1050	1,711.11 cy	74.34 /cy	127,204
Underlayment vapor barrier, visqueen membrane to 6 mil	1200	138,600.00 sf	0.34 /sf	46,570
Concrete, ready mix, regular weight, slabs/mats, 5000 psi	0405	7,854.00 cy	245.10 /cy	1,925,042
Curing, sprayed membrane curing compound	0300	1,386.00 csf	24.86 /csf	34,451
Fine grading, fine grade for slab on grade, machine	1100	15,400.00 sy	2.17 /sy	33,431
				2,207,904
New Hangar Floor and Ramp Area		138,600.00 sf	15.93 /sf	2,207,904
03330 New Hangar Floor and Ramp Area				
<i>A01010205 Raft Foundations</i>				
C.I.P. concrete forms, mat foundation, plywood, 1 use, includes erecting, bracing, stripping and cleaning	0020	13,500.00 sfca	23.06 /sfca	311,258
Structural concrete, placing, foundation mat, pumped, over 20 C.Y., includes strike off & consolidation, excludes material	2950	7,854.00 cy	16.28 /cy	127,867
				439,126
<i>A01010205 Raft Foundations</i>				
New Hangar Floor and Ramp Area		231,000.00 sf	1.90 /sf	439,126
31315 Contaminated Soil Removal				
<i>A0116029X Other Hazardous Selective Building Demolition</i>				
Mobilization or demobilization, dozer, loader, backhoe or excavator, 70 H.P. to 150 H.P., up to 50 miles	0020	10.00 ea	3,129.20 /ea	31,292
Soils for earthwork, common borrow, spread with 200 H.P. dozer, includes load at pit and haul, 2 miles round trip, excludes compaction	0200	21,966.60 cy	41.07 /cy	902,123
Excavating, bulk bank measure, 2 C.Y. capacity = 130 C.Y./hour, backhoe, hydraulic, crawler mounted, excluding truck loading	0260	21,966.67 bcy	2.67 /bcy	58,636
Backfill, bulk, 6" to 12" lifts, dozer backfilling, compaction with sheepsfoot roller	1700	21,966.60 ecy	71.43 /ecy	1,569,078
Hauling, excavated or borrow material, loose cubic yards, 20 mile round trip, 0.5 loads/hour, 20 C.Y. dump trailer, highway haulers, excludes loading	1255	21,966.67 lcy	102.08 /lcy	2,242,371
				4,803,499
<i>A0116029X Other Hazardous Selective Building Demolition</i>				
Contaminated Soil Removal		21,966.00 cy	218.68 /cy	4,803,499
Z08b Substitution 8b: 60% Concrete Slab Removal		1.00 ls	8,972,767.94 /ls	8,972,768

DETAIL REPORT

Project: NASA Moffett Hangar 1
 Design Stage: Concept
 Project No.: 421240.01.40

Estimator: Edgerton, R
 Estimate No.: <Estimate Number>
 Rev #/Date: <Rev. No. / Date>

Description	Item	Takeoff Quantity	Total Cost/Unit	Total Amount
Z08c Substitution 8c: 100% Concrete Slab Removal				
02225 Concrete Demo				
<i>A0116019X Other Non-Hazardous Selective Building Demolition</i>				
Bldg. footings and foundations demolition, floors, concrete slab on grade, concrete, rod reinforced, 6" thick, excludes disposal costs and dump fees	0440	231,000.00 sf	9.69 /sf	2,237,468
Demo Material handling, loading & trucking, machine loading truck, includes 2 mile haul, cost to be added to demolition cost.	3080	10,462.96 cy	28.63 /cy	299,597
				2,537,064
<i>A0116019X Other Non-Hazardous Selective Building Demolition</i>			/sf	
Concrete Demo		231,000.00 sf	10.98 /sf	2,537,064
03330 New Hangar Floor and Ramp Area				
<i>A01010302 Structural Slab on Grade</i>				
Aggregate, sand, washed, for concrete, loaded at the pit, includes material only	0950	1,425.93 cy	48.16 /cy	68,678
Aggregate, stone, 3/4" to 1-1/2", includes material only	1050	2,851.85 cy	74.34 /cy	212,007
Under slab vapor barrier, visqueen membrane to 6 mil	1200	231,000.00 sf	0.34 /sf	77,616
Concrete, ready mix, regular weight, slabs/mats, 5000 psi	0405	13,090.00 cy	245.10 /cy	3,208,403
Curing, sprayed membrane curing compound	0300	2,310.00 csf	24.86 /csf	57,418
Fine grading, fine grade for slab on grade, machine	1100	25,666.67 sy	2.17 /sy	55,719
				3,679,841
<i>A01010302 Structural Slab on Grade</i>			/sf	
New Hangar Floor and Ramp Area		231,000.00 sf	15.93 /sf	3,679,841
03330 New Hangar Floor and Ramp Area				
<i>A01010205 Raft Foundations</i>				
C.I.P. concrete forms, mat foundation, plywood, 1 use, includes erecting, bracing, stripping and cleaning	0020	22,500.00 sfca	23.06 /sfca	518,764
Structural concrete, placing, foundation mat, pumped, over 20 C.Y., includes strike off & consolidation, excludes material	2950	13,090.00 cy	16.28 /cy	213,112
				731,876
<i>A01010205 Raft Foundations</i>			/sf	
New Hangar Floor and Ramp Area		231,000.00 sf	3.17 /sf	731,876
31315 Contaminated Soil Removal				
<i>A0116029X Other Hazardous Selective Building Demolition</i>				
Mobilization or demobilization, dozer, loader, backhoe or excavator, 70 H.P. to 150 H.P., up to 50 miles	0020	25.00 ea	408.65 /ea	10,216
Soils for earthwork, common borrow, spread with 200 H.P. dozer, includes load at pit and haul, 2 miles round trip, excludes compaction	0200	36,611.00 cy	41.07 /cy	1,503,538
Excavating, bulk bank measure, 2 C.Y. capacity = 130 C.Y./hour, backhoe, hydraulic, crawler mounted, excluding truck loading	0260	36,611.11 bcy	2.67 /bcy	97,726
Backfill, bulk, 6" to 12" lifts, dozer backfilling, compaction with sheepsfoot roller	1700	36,611.00 ecy	71.43 /ecy	2,615,129
Hauling, excavated or borrow material, loose cubic yards, 20 mile round trip, 0.5 loads/hour, 20 C.Y. dump trailer, highway haulers, excludes loading	1255	36,611.11 lcy	102.08 /lcy	3,737,286
				7,963,895
<i>A0116029X Other Hazardous Selective Building Demolition</i>			/sf	
Contaminated Soil Removal		36,611.11 cy	217.53 /cy	7,963,895
Z08c Substitution 8c: 100% Concrete Slab Removal		1.00 Is	14,912,676.00 /Is	14,912,676

Description	Item	Takeoff Quantity	Total Cost/Unit	Total Amount
Z09 Substitution 9: Thin Film PV Install				
26030 Thin Film Photovoltaic Install on Roof Panels				
<i>A01110103 Main Switchboards</i>				
Switchgear 277/480v, avg cost per amp	2000	5,000.00 amp	79.64 /amp	398,212
<i>A01110103 Main Switchboards</i>			/amp	398,212
<i>A01110105 Panels</i>				
Thin Film Photovoltaic Panels	1000	2,354,000.00 watt	10.54 /watt	24,818,961
<i>A01110105 Panels</i>			/ea	24,818,961
<i>A01110201 Branch Wiring</i>				
Branch power raceway, to 3/4" EMT w/ conductors, avg, S/sf	6020	198,500.00 sf	3.84 /sf	763,052
<i>A01110201 Branch Wiring</i>			/sf	763,052
Thin Film Photovoltaic Install on Roof Panels		2,354,000.00 watt	11.04 /watt	25,980,225
Z09 Substitution 9: Thin Film PV Install		2,354,000.00 watt	11.04 /watt	25,980,225

Project NASA Moffett Hangar 1
 Design Stage: Concept
 Project No.: 421240.01.40

Estimator: Edgerton, R
 Estimate No.: <Estimate Number>
 Rev #/Date: <Rev. No. / Date>

Description	Item	Takeoff Quantity	Total Cost/Unit	Total Amount
Z10 Substitution 10: Std Profile Metal Panels				
26030				
<i>A01040101 Roof Covering</i>				
Steel roofing panels, attached to steel frame, corrugated or ribbed, Galv NO PAINT, 20 gauge	0400	-543,350.00 sf	1.40 /sf	(761,934)
<i>A01040101 Roof Covering</i>			/sf	<u>(761,934)</u>
Z10 Substitution 10: Std Profile Metal Panels		1.00 Is	(761,933.89) /Is	(761,934)

DETAIL REPORT

Project NASA Moffett Hangar 1
 Design Stage: Concept
 Project No.: 421240.01.40

Estimator: Edgerton, R
 Estimate No.: <Estimate Number>
 Rev #/Date: <Rev. No. / Date>

Description	Item	Takeoff Quantity	Total Cost/Unit	Total Amount
Z11 Substitution 11: 1.98 mils Zinc Coat Metal Panels				
26030				
<i>A01040101 Roof Covering</i>				
Steel roofing panels, attached to steel frame, corrugated or ribbed, 1.98 mils Zinc Coat, 20 gauge	0400	543,350.00 sf	5.61 /sf	3,047,735
<i>A01040101 Roof Covering</i>			/sf	<u>3,047,735</u>
26030				3,047,735
Z11 Substitution 11: 1.98 mils Zinc Coat Metal Panels		1.00 Is	3,047,735.44 /Is	3,047,735

DETAIL REPORT

Project NASA Moffett Hangar 1
 Design Stage: Concept
 Project No.: 421240.01.40

Estimator: Edgerton, R
 Estimate No.: <Estimate Number>
 Rev #/Date: <Rev. No. / Date>

Description	Item	Takeoff Quantity	Total Cost/Unit	Total Amount
Z12 Substitution 12: 3.24 mils Zinc Coat Metal Panels				
26030				
<i>A01040101 Roof Covering</i>				
Steel roofing panels, attached to steel frame, corrugated or ribbed, 3.24 mils Zinc Coat, 20 gauge	0400	543,350.00 sf	8.41 /sf	4,571,603
				<u>4,571,603</u>
<i>A01040101 Roof Covering</i>				
				<u>4,571,603</u>
26030				
Z12 Substitution 12: 3.24 mils Zinc Coat Metal Panels		1.00 Is	4,571,603.18 /Is	4,571,603

DETAIL REPORT

Project NASA Moffett Hangar 1
 Design Stage: Concept
 Project No.: 421240.01.40

Estimator: Edgerton, R
 Estimate No.: <Estimate Number>
 Rev #/Date: <Rev. No. / Date>

Description	Item	Takeoff Quantity	Total Cost/Unit	Total Amount
Z13 Substitution 13 - Infrared Heat Strips at Roof Crown				
26026 Infrared Heaters				
<i>A01090505 Electric Heating</i>				
Electric heating, infra-red heat	5550	2,000.00 lf	703.62 /lf	1,407,231
<i>A01090505 Electric Heating</i>				<u>1,407,231</u>
Infrared Heaters				1,407,231
Z13 Substitution 13 - Infrared Heat Strips at Roof Crown		1.00 Is	1,407,230.81 /Is	1,407,231

DETAIL REPORT

Project: NASA Moffett Hangar 1
 Design Stage: Concept
 Project No.: 421240.01.40

Estimator: Edgerton, R
 Estimate No.: <Estimate Number>
 Rev #/Date: <Rev. No. / Date>

Description	Item	Takeoff Quantity	Total Cost/Unit	Total Amount
<i>A Option A: Basic Re-Skinning, Maintain Existing Hangar Use</i>		1.00 Is	40,718,984.57 /Is	40,718,985
<i>B Option B: Re-Skinning with Upgrades (Geotechnical, Structural and Slab</i>		1.00 Is	45,394,318.56 /Is	45,394,319
<i>C Option C: Re-Skinning with Upgrades (Geotechnical, Structural and Slab</i>		1.00 Is	45,367,433.45 /Is	45,367,433
<i>D Option D: Adaptive Re-Use, Re-Skinning with Upgrades (Geotechnical, St</i>		1.00 Is	45,264,130.18 /Is	45,264,130
<i>E1 Option E1: Layaway Plan after Re-Skinning (Annual Cost 2011 \$)</i>		1.00 yr	68,539.61 /yr	68,540
<i>E2 Option E2: Layaway Plan without Re-Skinning (Annual Cost 2011 \$)</i>		1.00 yr	3,775.95 /yr	3,776
<i>F Option F: Building Demolition</i>		1.00 Is	44,391,740.70 /Is	44,391,741
<i>Z01 Substitution 1: Redwood Roof Deck</i>		1.00 Is	3,302,042.53 /Is	3,302,043
<i>Z02 Substitution 2: Panelized Roof Deck Installation</i>		1.00 Is	(903,589.39) /Is	(903,589)
<i>Z03 Substitution 3: U.S. Corrugated Glass</i>		1.00 Is	3,099,479.91 /Is	3,099,480
<i>Z04 Substitution 4: Flat Glass in Lieu of Corrugated Glass</i>		1.00 Is	(10,317,325.94) /Is	(10,317,326)
<i>Z05 Substitution 5 - Corrugated Fiberglass in Lieu of Corrugated Glass</i>		1.00 Is	(12,026,399.23) /Is	(12,026,399)
<i>Z06 Substitution 6: Translucent Panels for Window Openings</i>		1.00 Is	(11,353,324.55) /Is	(11,353,325)
<i>Z07 Substitution 7: Custom Panel Profiles</i>		1.00 ea	195,572.61 /ea	195,573
<i>Z08a Substitution 8a: 30% Concrete Slab Removal</i>		1.00 Is	4,688,137.46 /Is	4,688,137
<i>Z08b Substitution 8b: 60% Concrete Slab Removal</i>		1.00 Is	8,972,767.94 /Is	8,972,768
<i>Z08c Substitution 8c: 100% Concrete Slab Removal</i>		1.00 Is	14,912,676.00 /Is	14,912,676
<i>Z09 Substitution 9: Thin Film PV Install</i>		2,354,000.00 watt	11.04 /watt	25,980,225
<i>Z10 Substitution 10: Std Profile Metal Panels</i>		1.00 Is	(761,933.89) /Is	(761,934)
<i>Z11 Substitution 11: 1.98 mils Zinc Coat Metal Panels</i>		1.00 Is	3,047,735.44 /Is	3,047,735
<i>Z12 Substitution 12: 3.24 mils Zinc Coat Metal Panels</i>		1.00 Is	4,571,603.18 /Is	4,571,603
<i>Z13 Substitution 13 - Infrared Heat Strips at Roof Crown</i>		1.00 Is	1,407,230.81 /Is	1,407,231

APPENDIX B – Market Conditions Assessment



CONSTRUCTION MARKET ASSESSMENT

NOTE: The purpose of this exhibit is to facilitate the adjustment of project costs to account for local market conditions. The estimator has scored and weighted this project based upon knowledge gained and observations made during production of the cost estimate.

Market Impact, Percent

Project Delivery Issues	INPUT		Market Impact, Percent								SCORE	ESTIMATOR COMMENTS	
	y/n	WEIGHT	0	10	20	30	40	50	60	70			80
			-			Average			+			0-100	
1. General Economy	Y	30%	Prosperous			Normal			Hard Times			30%	Bid prices seem to be normalizing. Bid prices seem to be normalizing. Construction market seems to be picking up with recent
Local Business Trend	Y	75%	stimulated			normal			depressed			75%	
Construction Volume	Y	75%	high			normal			low			75%	
Unemployment	Y	80%	low			normal			high			80%	
Interest Rates	Y	90%	high			normal			low			90%	
Insurance Rates	Y	25%	high			normal			low			25%	
2. Type of Work	Y	15%	Limited			Average			Extensive			15%	
Local Capacity/Experience	Y	60%	limited			average			extensive			60%	
Manual Operations	Y	25%	extensive			average			limited			25%	
Mechanized Operations	Y	25%	limited			normal			extensive			25%	
3. Project Status	Y	10%	Poor			Average			Good			10%	Will make for excellent press.
Prestige Project	Y	100%	small			average			large			100%	
Project Size	Y	40%	small			average			large			40%	
Opportunity (follow-on, sustaining work)	Y	10%	limited			average			extensive			10%	
Contract Terms	Y	70%	DBB			CM			Incentive			70%	
Number of Bidders	Y	60%	limited			average			extensive			60%	
4. Craft Labor	Y	25%	Poor			Average			Good			25%	
Training	Y	75%	poor			average			good			75%	
Pay	Y	30%	high			average			low			30%	
Wage Structure	Y	25%	Union			Davis Bacon			Open Shop			25%	
Supply	Y	70%	scarce			normal			surplus			70%	
5. Supervision	Y	5%	Poor			Average			Good			5%	
Training	Y	75%	poor			average			good			75%	
Pay	Y	75%	low			average			good			75%	
Supply	Y	75%	scarce			normal			surplus			75%	
6. Job Conditions	Y	5%	Poor			Average			Good			5%	
Management	Y	75%	poor			average			good			75%	
Site & Materials	Y	10%	unfavorable			average			favorable			10%	
Safety Issues	Y	25%	unfavorable			average			favorable			25%	
Workmanship Required	Y	10%	best			regular			passable			10%	
Length of Operations	Y	50%	short			average			long			50%	
7. Weather	Y	3%	Bad			Fair			Good			3%	
Precipitation	Y	25%	high			average			low			25%	
Cold	Y	50%	extreme			average			low			50%	
Heat	Y	50%	high			average			low			50%	
8. Equipment	Y	2%	Poor			Normal			Good			2%	
Availability/Appropriate	Y	40%	poor			normal			good			40%	
Condition	Y	75%	poor			fair			good			75%	
Maintenance & Repair	Y	75%	slow			average			quick			75%	
9. Potential for Delays	Y	5%	High			Normal			Low			5%	
Schedule Flexibility	Y	25%	poor			average			good			25%	
Site Access/Delivery	Y	5%	slow			normal			easy			5%	
Long Lead Items/Expediting	Y	50%	poor			average			good			50%	
Construction Documents	Y	35%	poor			average			good			35%	
		100%				Total Bid Impact, Percent of \$						-2.22%	

APPENDIX C – Escalation Calculations



Project Number	421240	
Project Name	Moffett Field Hangar 1 Rehab	
Prepared By	Rob Edgerton/PDX	
Project Type	APHG	Airport Hanger
Estimate Class	Class 4, Feasibility	
Rounding	100000	
Calculate with Gross Receipts Tax?	No	

	Dates	DURATION (mnths)	INDEX VALUE	DESIGN	SDC
Today's Date	11/7/2011		1685	1592	1592
Estimate Date (Escalation Start Point)	11/7/2011		1685	1592	1592
Design Start Date	11/7/2011	8	1685	1592	1592
Design Completion	7/7/2012		1746	1616	1616
Bid Advertisement Date	7/7/2012	0	1746	1616	1616
Notice to Proceed/Construction Start	7/7/2012	18	1746	1616	1616
Mid Point of Construction	4/7/2013		1820	1639	1639
Construction Completion	1/5/2014		1901	1677	1677

Construction Cost		
Construction Amount	\$1,000,000	
Estimating Contingency \$	\$200,000	20.00%
Subtotal	\$1,200,000	
Escalation	\$100,000	8.00% Escalation %
Subtotal	\$1,300,000	
Market Adjustment Factor	\$0	-2.22%
Construction Cost	\$1,300,000	



Project Number	421240	
Project Name	Moffett Field Hangar 1 Rehab	
Prepared By	Rob Edgerton/PDX	
Project Type	APHG	Airport Hanger
Estimate Class	Class 4, Feasibility	
Rounding	100000	
Calculate with Gross Receipts Tax?	No	

	Dates	DURATION (mnths)	INDEX VALUE	DESIGN	SDC
Today's Date	11/7/2011		1685	1592	1592
Estimate Date (Escalation Start Point)	11/7/2011		1685	1592	1592
Design Start Date	11/7/2011	8	1685	1592	1592
Design Completion	7/7/2012		1746	1616	1616
Bid Advertisement Date	7/7/2012	12	1746	1616	1616
Notice to Proceed/Construction Start	7/7/2013	18	1847	1650	1650
Mid Point of Construction	4/7/2014		1930	1693	1693
Construction Completion	1/5/2015		2018	1743	1743

Construction Cost		
Construction Amount	\$1,000,000	
Estimating Contingency \$	\$200,000	20.00%
Subtotal	\$1,200,000	
Escalation	\$200,000	14.48% Escalation %
Subtotal	\$1,400,000	
Market Adjustment Factor	\$0	-2.22%
Construction Cost	\$1,400,000	



Project Number	421240	
Project Name	Moffett Field Hangar 1 Rehab	
Prepared By	Rob Edgerton/PDX	
Project Type	APHG	Airport Hanger
Estimate Class	Class 4, Feasibility	
Rounding	100000	
Calculate with Gross Receipts Tax?	No	

	Dates	DURATION (mnths)	INDEX VALUE	DESIGN	SDC
Today's Date	11/7/2011		1685	1592	1592
Estimate Date (Escalation Start Point)	11/7/2011		1685	1592	1592
Design Start Date	11/7/2011	8	1685	1592	1592
Design Completion	7/7/2012		1746	1616	1616
Bid Advertisement Date	7/7/2012	24	1746	1616	1616
Notice to Proceed/Construction Start	7/7/2014	18	1959	1709	1709
Mid Point of Construction	4/7/2015		2047	1760	1760
Construction Completion	1/5/2016		2126	1811	1811

Construction Cost		
Construction Amount	\$1,000,000	
Estimating Contingency \$	\$200,000	20.00%
Subtotal	\$1,200,000	
Escalation	\$300,000	21.44% Escalation %
Subtotal	\$1,500,000	
Market Adjustment Factor	\$0	-2.22%
Construction Cost	\$1,500,000	



Project Number	421240	
Project Name	Moffett Field Hangar 1 Rehab	
Prepared By	Rob Edgerton/PDX	
Project Type	APHG	Airport Hanger
Estimate Class	Class 4, Feasibility	
Rounding	100000	
Calculate with Gross Receipts Tax?	No	

	Dates	DURATION (mnths)	INDEX VALUE	DESIGN	SDC
Today's Date	11/7/2011		1685	1592	1592
Estimate Date (Escalation Start Point)	11/7/2011		1685	1592	1592
Design Start Date	11/7/2011	8	1685	1592	1592
Design Completion	7/7/2012		1746	1616	1616
Bid Advertisement Date	7/7/2012	36	1746	1616	1616
Notice to Proceed/Construction Start	7/7/2015	18	2074	1777	1777
Mid Point of Construction	4/6/2016		2151	1829	1829
Construction Completion	1/4/2017		2232	1880	1880

Construction Cost		
Construction Amount	\$1,000,000	
Estimating Contingency \$	\$200,000	20.00%
Subtotal	\$1,200,000	
Escalation	\$300,000	27.65% Escalation %
Subtotal	\$1,500,000	
Market Adjustment Factor	\$0	-2.22%
Construction Cost	\$1,500,000	



Project Number	421240	
Project Name	Moffett Field Hangar 1 Rehab	
Prepared By	Rob Edgerton/PDX	
Project Type	APHG	Airport Hanger
Estimate Class	Class 4, Feasibility	
Rounding	100000	
Calculate with Gross Receipts Tax?	No	

	Dates	DURATION (mnths)	INDEX VALUE	DESIGN	SDC
Today's Date	11/7/2011		1685	1592	1592
Estimate Date (Escalation Start Point)	11/7/2011		1685	1592	1592
Design Start Date	11/7/2011	8	1685	1592	1592
Design Completion	7/7/2012		1746	1616	1616
Bid Advertisement Date	7/7/2012	48	1746	1616	1616
Notice to Proceed/Construction Start	7/6/2016	18	2177	1846	1846
Mid Point of Construction	4/6/2017		2261	1896	1896
Construction Completion	1/4/2018		2349	1942	1942

Construction Cost		
Construction Amount	\$1,000,000	
Estimating Contingency \$	\$200,000	20.00%
Subtotal	\$1,200,000	
Escalation	\$400,000	34.15% Escalation %
Subtotal	\$1,600,000	
Market Adjustment Factor	\$0	-2.22%
Construction Cost	\$1,600,000	



Project Number	421240	
Project Name	Moffett Field Hangar 1 Rehab	
Prepared By	Rob Edgerton/PDX	
Project Type	APHG	Airport Hanger
Estimate Class	Class 4, Feasibility	
Rounding	100000	
Calculate with Gross Receipts Tax?	No	

	Dates	DURATION (mnths)	INDEX VALUE	DESIGN	SDC
Today's Date	11/7/2011		1685	1592	1592
Estimate Date (Escalation Start Point)	11/7/2011		1685	1592	1592
Design Start Date	11/7/2011	8	1685	1592	1592
Design Completion	7/7/2012		1746	1616	1616
Bid Advertisement Date	7/7/2012	60	1746	1616	1616
Notice to Proceed/Construction Start	7/6/2017	18	2290	1912	1912
Mid Point of Construction	4/6/2018		2379	1956	1956
Construction Completion	1/4/2019		2440	1985	1985

Construction Cost		
Construction Amount	\$1,000,000	
Estimating Contingency \$	\$200,000	20.00%
Subtotal	\$1,200,000	
Escalation	\$500,000	41.16% Escalation %
Subtotal	\$1,700,000	
Market Adjustment Factor	\$0	-2.22%
Construction Cost	\$1,700,000	



Project Number	421240	
Project Name	Moffett Field Hangar 1 Rehab	
Prepared By	Rob Edgerton/PDX	
Project Type	APHG	Airport Hanger
Estimate Class	Class 4, Feasibility	
Rounding	100000	
Calculate with Gross Receipts Tax?	No	

	Dates	DURATION (mnths)	INDEX VALUE	DESIGN	SDC
Today's Date	11/7/2011		1685	1592	1592
Estimate Date (Escalation Start Point)	11/7/2011		1685	1592	1592
Design Start Date	11/7/2011	8	1685	1592	1592
Design Completion	7/7/2012		1746	1616	1616
Bid Advertisement Date	7/7/2012	72	1746	1616	1616
Notice to Proceed/Construction Start	7/6/2018	18	2409	1971	1971
Mid Point of Construction	4/6/2019		2440	1985	1985
Construction Completion	1/4/2020		2440	1985	1985

Construction Cost		
Construction Amount	\$1,000,000	
Estimating Contingency \$	\$200,000	20.00%
Subtotal	\$1,200,000	
Escalation	\$500,000	44.75% Escalation %
Subtotal	\$1,700,000	
Market Adjustment Factor	\$0	-2.22%
Construction Cost	\$1,700,000	

APPENDIX D – AACE Estimate Definitions

AACE – Classification System

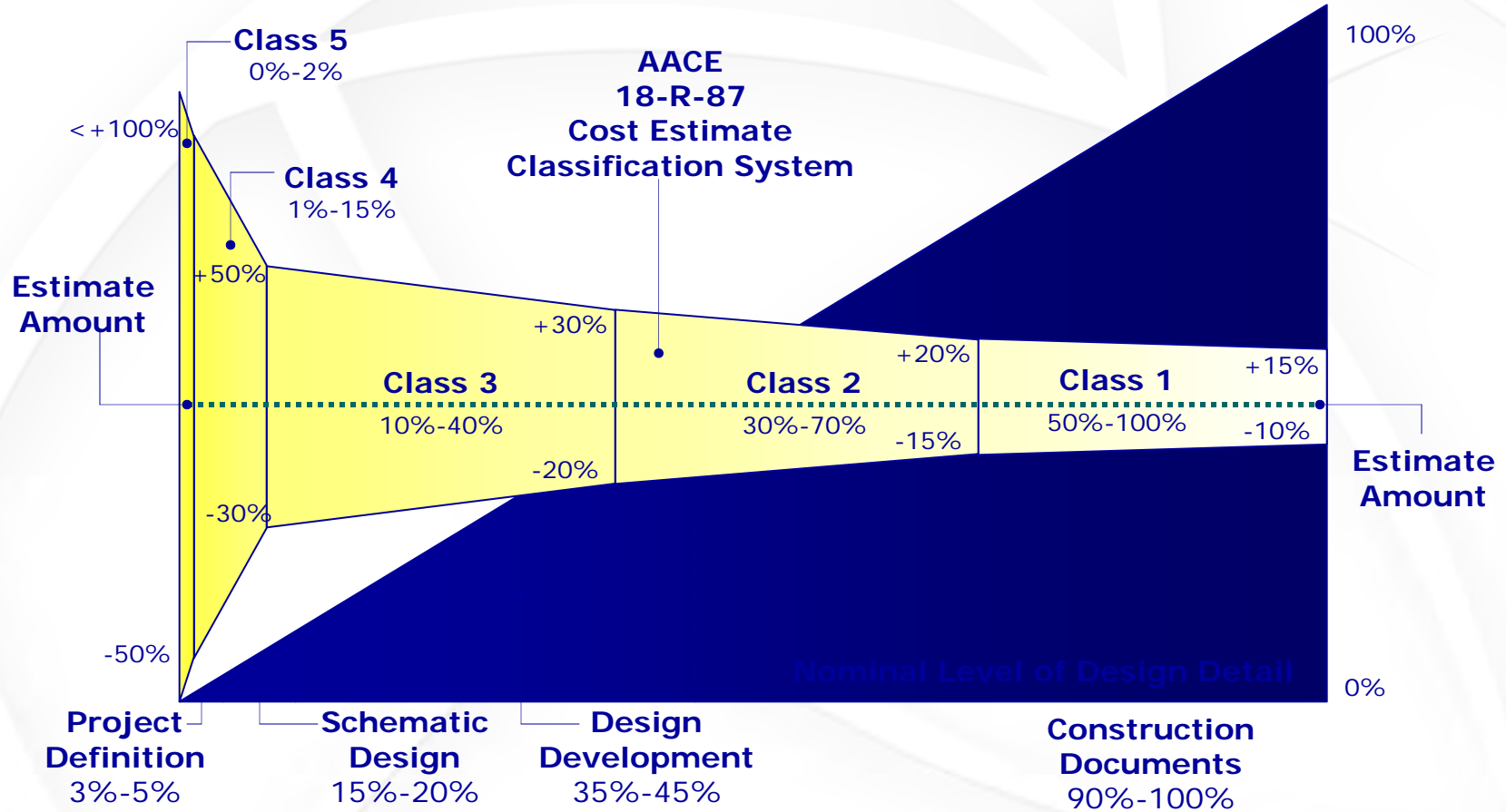

Construction Cost Estimate Accuracy Ranges

Estimate Class	Class 5	Class 4	Class 3	Class 2	Class 1
LEVEL OF PROJECT DEFINITION Expressed as a % of complete definition	0% to 2%	1% to 15%	10% to 40%	30% to 70%	50% to 100%
END USAGE <small>Typical Purpose of Estimate</small>	Concept Screening	Study or Feasibility	Budget Authorization, or Control	Control or Bid / Tender	Check Estimate or Bid / Tender
METHODOLOGY <small>Typical estimating method</small>	Capacity Factored, Parametric Models, Judgment, or Analogy	Equipment Factored or Parametric Models	Semi-Detailed Unit Costs with Assembly Level Line Items	Detailed Unit Cost with Forced Detailed Take-Off	Detailed Unit Cost with Detailed Take-Off
EXPECTED ACCURACY RANGE <small>Typical variation in low and high ranges [a]</small>	L: -20% to -50% H: +30% to +100%	L: -15% to -30% H: +20% to +50%	L: -10% to -20% H: +10% to +30%	L: -5% to -15% H: +5% to +20%	L: -3% to -10% H: +3% to +15%
PREPARATION EFFORT <small>Typical degree of effort relative to least cost index of 1 [b]</small>	1	2 to 4	3 to 10	4 to 20	5 to 100
REFINED CLASS DEFINITION	Class 5 estimates are generally prepared based on very limited information, and subsequently have very wide accuracy ranges. As such, some companies and organizations have elected to determine that due to the inherent inaccuracies, such estimates cannot be classified in a conventional and systematic manner. Class 5 estimates, due to the requirements of end use, may be prepared within a very limited amount of time and with very little effort expended - sometimes requiring less than 1 hour to prepare. Often, little more than proposed plant type, location, and capacity are known at the time of estimate preparation.	Class 4 estimates are generally prepared based on very limited information, and subsequently have very wide accuracy ranges. They are typically used for project screening, determination of feasibility, concept evaluation, and preliminary budget approval. Typically, engineering is from 1% to 5% complete, and would comprise at a minimum the following: plant capacity, block schematics, indicated layout, process flow diagrams (PFDs) for main process systems and preliminary engineered process and utility equipment lists. Level of Project Definition Required: 1% to 15% of full project definition.	Class 3 estimates are generally prepared to form the basis for budget authorization, appropriation, and/or funding. As such, they typically form the initial control estimate against which all actual costs and resources will be monitored. Typically, engineering is from 10% to 40% complete, and would comprise at a minimum the following: process flow diagrams, utility flow diagrams, preliminary piping and instrument diagrams, utility flow diagrams, preliminary piping and instrument diagrams, plot plan, developed layout drawings, and essentially complete engineering process and utility equipment lists. Level Of Project Definition Required: 10% to 40% of full project definition.	Class 2 estimates are generally prepared to form a detailed control baseline against which all project work is monitored in terms of cost and progress control. For contractors, this class of estimate is often used as the "bid" estimate to establish contract value. Typically, engineering is from 30% to 70% complete, and would comprise at a minimum the following: Process flow diagrams, utility flow diagrams, piping and instrument flow diagrams, heat and material balances, final plot plan, final layout drawings, complete engineered process and utility equipment lists, single line diagrams for electrical, electrical equipment and motor schedules, vendor quotations, detailed project execution plans, resourcing and work force plans, etc.	Class 1 estimates are generally prepared for discrete parts or sections of the total project rather than generating this level of detail for the entire project. The parts of the project estimated at this level of detail will typically be used by subcontractors for bids, or by owners for check estimates. The updated estimate is often referred to as the current control estimate and becomes the new baseline for cost/schedule control of the project. Class 1 estimates may be prepared for parts of the project to comprise a fair price estimate or bid check estimate to compare against a contractor's bid estimate, or to evaluate/dispute claims. Typically, engineering is from 50% to 100% complete, and would comprise virtually all engineering and design documentation of the project, and complete project execution and commissioning plans. Level for Project Definition Required: 50% to 100% of full project definition.
END USAGE DEFINED	Class 5 estimates are prepared for any number of strategic business planning purposes, such as but not limited to market studies, assessment of initial viability, evaluation of alternate schemes, project screening, project location studies, evaluation of resource needs and budgeting, long-range capital planning, etc.	Class 4 estimates are prepared for a number of purposes, such as but not limited to, detailed strategic planning, business development, project screening at more developed stages, alternative scheme analysis, confirmation of economic and/or technical feasibility, and preliminary budget approval or approval to proceed to next stage.	Class 3 estimates are typically prepared to support full project funding requests, and become the first of the project phase "control estimate" against which all actual costs and resources will be monitored for variations to the budget. They are used as the project budget until replaced by more detailed estimates. In many owner organizations, a Class 3 estimate may be the last estimate required and could well form the only basis for cost/schedule control.	Class 2 estimates are typically prepared as the detailed control baseline against which all actual costs and resources will now be monitored for variation to the budget, and form a part of the change/variation control program.	Class 1 estimates are typically prepared to form a current control estimate to be used as the final control baseline against which all actual costs and resources will now be monitored for variations to the budget, and form a part of the change/variation control program. They may be used to evaluate bid checking, to support vendor/contractor negotiations, or for claim evaluations and dispute resolution.
ESTIMATING METHODS USED	Class 5 estimates virtually always use stochastic estimating methods such as cost/capacity curves and factors, scale of operations factors, Lang factors, Handy-Whitman factors, Chilton factors, Peters-Timmerhaus factors, Guthrie factors, and other parametric and modeling techniques.	Class 4 estimates virtually always use stochastic estimating methods such as cost/capacity curves and factors, scale of operations factors, Lang factors, Hand factors, Chilton factors, Peters-Timmerhaus factors, Guthrie factors, the Miller method, gross unit costs/ratios, and other parametric and modeling techniques.	Class 3 estimates usually involve more deterministic estimating methods that stochastic methods. They usually involve a high degree of unit cost line items, although these may be at an assembly level of detail rather than individual components. Factoring and other stochastic methods may be used to estimate less-significant areas of the project.	Class 2 estimates always involve a high degree of deterministic estimating methods. Class 2 estimates are prepared in great detail, and often involve tens of thousands of unit cost line items. For those areas of the project still undefined, an assumed level of detailed takeoff (forced detail) may be developed to use as line items in the estimate instead of relying on factoring methods.	Class 1 estimates involve the highest degree of deterministic estimating methods, and require a great amount of effort. Class 1 estimates are prepared in great detail, and thus are usually performed on only the most important or critical areas of the project. All items in the estimate are usually unit cost line items based on actual design quantities.
EXPECTED ACCURACY RANGE	Typical accuracy ranges for Class 5 estimates are -20% to 50% on the low side, and +30% to +100% on the high side, depending on the technological complexity of the project, appropriate contingency determination. Ranges could exceed those shown in unusual circumstances.	Typical accuracy ranges for Class 4 estimates are -15% to -30% on the low side, and +20% to +50% on the high side, depending on the technological complexity of the project, appropriate reference information, and the inclusion of an appropriate contingency determination. Ranges could exceed those shown in unusual circumstances.	Typical accuracy ranges for Class 3 estimates are -10% to 20% on the low side, and +10% to +30% on the high side, depending on the technological complexity of the project, appropriate reference information, and the inclusion of an appropriate contingency determination. Ranges could exceed those shown in unusual circumstances.	Typical accuracy ranges for Class 2 estimates are -5% to 15% on the low side, and +5% to +20% on the high side, depending on the technological complexity of the project, appropriate reference information, and the inclusion of an appropriate contingency determination. Ranges could exceed those shown in unusual circumstances.	Typical accuracy ranges for Class 1 estimates are -3% to 10% on the low side, and +3% to +15% on the high side, depending on the technological complexity of the project, appropriate reference information, and the inclusion of an appropriate contingency determination. Ranges could exceed those shown in unusual circumstances.
EFFORT TO PREPARE (for US\$20MM project):	As little as 1 hour or less to prepare to perhaps more than 200 hours, depending on the project and the estimating methodology used.	Typically, as little as 20 hours or less to perhaps more than 300 hours, depending on the project and the estimating methodology used.	Typically, as little as 150 hours or less to perhaps more than 1500 hours, depending on the project and the estimating methodology used.	Typically, as little as 300 hours or less to perhaps more than 3000 hours, depending on the project and the estimating methodology used. Bid Estimates typically require more effort than estimates used for funding or control purposes	Class 1 estimates require the most effort to create, and as such are generally developed for only selected areas of the project, or for bidding purposes. A complete Class 1 estimate may involve as little as 600 hours or less, to perhaps more than 6,000 hours, depending on the project and the estimating methodology used. Bid estimate typically require more effort than estimates used for funding or control purposes.
ANSI Standard Reference Z94.2-1989 name; Alternate Estimate Names, Terms, Expressions, Synonyms:	Order of Magnitude Estimate; Ratio, ballpark, blue sky, seat-of-pants, ROM, idea study, prospect estimate, concession license estimate, guesstimate, rule-of thumb.	Budget Estimate; Screening, top-down, feasibility, authorization, factored, pre-design, pre-study.	Budget Estimate; Budget, scope, sanction, semi-detailed, authorization, preliminary control, concept study, development, basic engineering phase estimate, target estimate.	Definitive Estimate; Detailed Control, forced detail, execution phase, master control, engineering, bid, tender, change order estimate.	Definitive Estimate; Full detail, release, fall-out, tender, firm price, bottoms-up, final, detailed control, forced detail, execution phase, master control, fair price, definitive, change order estimate.

Estimate Class	Class 5	Class 4	Class 3	Class 2	Class 1
Estimate Input Checklist and Maturity Index	Class 5	Class 4	Class 3	Class 2	Class 1
GENERAL PROJECT DATA					
Project Scope Description	General	Preliminary	Defined	Defined	Defined
Plant Production / Facility Capacity	Assumed	Preliminary	Defined	Defined	Defined
Plant Location	General	Approximate	Specific	Specific	Specific
Soils & Hydrology	None	Preliminary	Defined	Defined	Defined
Integrated Project Plan	None	Preliminary	Defined	Defined	Defined
Project Master Schedule	None	Preliminary	Defined	Defined	Defined
Escalation Strategy	None	Preliminary	Defined	Defined	Defined
Work Breakdown Structure	None	Preliminary	Defined	Defined	Defined
Project Code of Accounts	None	Preliminary	Defined	Defined	Defined
Contracting Strategy	Assumed	Assumed	Preliminary	Defined	Defined

ENGINEERING DELIVERABLES:	Class 5	Class 4	Class 3	Class 2	Class 1
Block Flow Diagrams	Started / Preliminary	Preliminary / Complete	Complete	Complete	Complete
Plot Plans		Started	Preliminary / Complete	Complete	Complete
Process Flow Diagrams (PFDs)		Started / Preliminary	Preliminary / Complete	Complete	Complete
Utility Flow Diagrams (UFDs)		Started / Preliminary	Preliminary / Complete	Complete	Complete
Piping & Instrument Diagrams (P&IDS)		Started	Preliminary / Complete	Complete	Complete
Heat and Material Balances		Started	Preliminary / Complete	Complete	Complete
Process Equipment List		Started / Preliminary	Preliminary / Complete	Complete	Complete
Utility Equipment List		Started / Preliminary	Preliminary / Complete	Complete	Complete
Electrical One Line Drawings		Started / Preliminary	Preliminary / Complete	Complete	Complete
Specifications and Datasheets		Started	Preliminary / Complete	Complete	Complete
General Equipment Arrangement Drawings		Started	Preliminary / Complete	Complete	Complete
Spare Parts Lists			Started / Preliminary	Preliminary	Complete
Architectural Details / Schedules		Started	Preliminary / Complete	Complete	Complete
Structural Details		Started	Preliminary / Complete	Complete	Complete
Mechanical Discipline Drawings			Started	Preliminary	Preliminary / Complete
Electrical Discipline Drawings			Started	Preliminary	Preliminary / Complete
System Discipline Drawings			Started	Preliminary	Preliminary / Complete
Civil/Site Discipline Drawings			Started	Preliminary	Preliminary / Complete
Demolition Details		Started	Preliminary / Complete	Complete	Complete

